

Experts in Bearing Solutions



General Catalog

Catálogo General





Introduction

Introducción

At Fersa we are able to improve every day as we grow in partnership with our customers thanks to the trust they have deposited on us.

Innovation, support and experience are the underlying forces that guarantee the quality of our bearings and of our service; but it is a passion for quality that drives Fersa towards seeking new challenges for constant improvement and customer satisfaction.

It is with this in mind that we hope the information contained in this new general catalog will be of interest to you.

En Fersa, mejoramos día a día gracias a nuestros clientes, gozando de su confianza para crecer a su lado.

La innovación, asistencia y nuestra experiencia son nuestros principales motores para garantizar la calidad de nuestros rodamientos y de nuestro servicio, sin olvidar que la pasión por la calidad hace que en Fersa tengamos siempre nuevos retos que acometer.

Por esta razón esperamos que la información recogida en este nuevo catálogo general sea de su interés.

Nomenclatures

Nomenclaturas

Nomenclatures / Nomenclaturas		
Z	Shield at one side	Tapa en una cara
ZZ	Shields at both sides	Tapas en las dos caras
RS	Rubbing seal at one side	Tapa retén en una cara
2RS	Rubbing seals at both sides	Tapa retén en una cara
M	Machined brass cage	Jaula de latón
N	Snap ring groove in outer ring	Ranura y anillo elástico en aro exterior
NR	Snap ring groove and snap ring in outer ring	Ranura y anillo elástico y arandela de seguridad en aro exterior
C3	Internal clearance greater than normal	Juego radial mayor que el normal

The contents of this publication are the copyright of Fersa Bearings and may not be reproduced (even extracts) unless prior written permission is granted. Every care has been taken to ensure the accuracy of the information contained in this publication but no liability for any loss or damage whether direct, indirect or consequential arising out of the use of the information contained herein.

Despite our best efforts to ensure the accuracy of the information contained in this document, errors or omissions cannot be completely ruled out. We disclaim any and all responsibility for such unintentional errors or omissions.

El contenido de esta publicación es propiedad de Fersa Bearings y no puede reproducirse (incluso parcialmente) sin autorización previa por escrito. Todos los datos se han tomado para garantizar la exactitud de la información contenida en esta publicación, pero no se hace responsable por cualquier pérdida o datos, ya sean directos, indirectos o consecuentes resultantes del uso de la información contenida en este documento.

A pesar de nuestro esfuerzo para asegurar la exactitud de los datos de este documento, declinamos toda responsabilidad sobre posibles errores u omisiones

Index

Índice

	Presentation of the company / Presentación de la empresa	7
00	Technical introduction / Introducción técnica	14
01	Single row tapered roller bearings / Rodamientos de rodillos cónicos	76
02	Double row tapered roller bearings / Rodamientos cónicos de doble hilera	164
03	Thrust tapered roller bearings / Rodamientos axiales cónicos	172
04	Deep groove ball bearings / Rodamientos radiales de bolas	180
05	Angular contact ball bearings / Rodamientos de bolas de contacto angular	210
06	Thrust ball bearings / Rodamientos axiales de bolas	232
07	Cylindrical roller bearings / Rodamientos cilíndricos	244
08	Commercial vehicle bearings / Rodamientos para vehículo industrial	260



The Company

La Empresa



Fersa Bearings is a European manufacturer of bearings driven by the search of excellence in order to guarantee premium quality in all Fersa products and services.

Fersa started operations in 1968 and has grown to be a global company with manufacturing and distribution centers worldwide from where we are able to provide the seamless customer service that our customers have come to know us for.

Continuous innovation, world class quality and seamless customer service are the distinguishing elements that make Fersa products a worldwide reference by the most demanding Aftermarket and T1/OEM customers

Fersa Bearings es un fabricante europeo de rodamientos orientado a la excelencia para garantizar la calidad Premium en todos los rodamientos Fersa.

Fersa empezó la fabricación en 1968 y se ha desarrollado para ser una empresa global con vocación internacional que cuenta en la actualidad con varios centros de distribución y fabricación desde los cuales atiende a sus clientes de todo el mundo para hacer del servicio y atención al cliente nuestra razón de ser.

La innovación, la calidad y el servicio son los elementos diferenciadores con los que hemos conseguido hacer de Fersa una marca de referencia en todo el mundo. Logrando el reconocimiento de los principales clientes fabricantes OEM/T1, pudiendo ofrecer también estos productos al mercado del Aftermarket.

The product

El producto



Fersa Bearings designs, manufactures and distributes standard and advanced bearings for almost every type of application in the automotive, heavy vehicle, industrial and agriculture markets.

All of the company's main processes directly related to product development, such as design, product engineering, as well as supplier quality assurance, and supply chain management are carried out at our central headquarters, located in Zaragoza, Spain.

Fersa Bearings diseña, fabrica y comercializa rodamientos estándar y especiales que cubren la mayor parte de las aplicaciones de los sectores de automoción, vehículo pesado, agrícola e industrial, que nuestros clientes del Aftermarket y T1/OEMs nos demandan.

Los procesos principales de la empresa como el diseño y desarrollo de la ingeniería de producto, la fabricación de nuestros productos así como la garantía de calidad y la gestión de la logística, las ventas y Marketing se realizan en nuestra oficina central en Zaragoza, España.



Manufacturing processes

Proceso de fabricación



The quality of our manufacturing processes has been recognized by the major automotive and heavy vehicle manufacturers and Tier 1 suppliers. These recognitions have been the driving force in all our continuous improvement plans.

The investments made in our production centers have increased not only our production capacity but also helped us introduce world class quality manufacturing lines that help us guarantee the highest bearing quality standards while reinforcing our flexibility in adapting to our customers individual needs.

La calidad de nuestro proceso de fabricación está avalada por los más importantes clientes OEMS, tanto en automoción como en vehículo pesado que nos han permitido desarrollar una cadena de suministro global en calidad y servicio con la excelencia como elemento determinante.

Las inversiones realizadas en nuestros centros productivos, nos han permitido incrementar nuestra capacidad productiva, automatizando los procesos de fabricación, manteniendo los altos estándares de calidad de nuestros rodamientos, a la vez que conservamos nuestra flexibilidad para adaptarnos a las necesidades de nuestros clientes.

Quality and innovation

Calidad e innovación



All our in-house processes such as prototyping, bearing design, and manufacturing production process, as well as all processes at our suppliers are subject to our strict testing processes. It is here where a major part of our investments in quality have gone during the last few years.

Fersa's commitment to innovation is one of the mainstays of its success. The evolution of our product line depth, large investments in R&D and a strong collaboration with world leading technical institutes together with our manufacturing experience, has allowed us to continuously launch new product families for the most demanding automotive markets.

The EFQM 4 Star Certification which our company recently obtained reinforces our commitment to excellence in all our manufacturing processes and service to our customers.

Toda la gama de rodamientos fabricados por Fersa Bearings está sometida en todas las fases de diseño, desarrollo, prototipado y fabricación en serie, a estrictos procesos de ensayo y validación de diseño y calidad de producto.

La apuesta por la Innovación es uno de los pilares del éxito de Fersa. La mejora en nuestra oferta de producto acompañada por importantes inversiones en el área de I+D; la estrecha colaboración con los mejores institutos tecnológicos a nivel mundial y nuestro expertise como fabricante han permitido el lanzamiento al mercado de nuevas familias de productos para completar nuestra gama.

La compañía ha obtenido la certificación EFQM 4 Star, lo que refuerza el compromiso adquirido con nuestros clientes para que el servicio y los procesos que rodean la fabricación de los rodamientos Fersa sean excelentes.

Global footprint

Presencia global



We are present in more than 60 countries in the five continents thanks to the dedication of the entire Fersa team over the last 45 years, a key contributing element to this globalization process has been the role of our distributors.

The constant support we receive from our customers makes us one of the leading brands of bearings suppliers worldwide.

Actualmente estamos presentes en los cinco continentes gracias al esfuerzo y la dedicación de todo el equipo Fersa, en el que nuestros distribuidores han sido un factor clave para la expansión de nuestra marca en los diferentes mercados.

El reconocimiento que en Fersa Bearings recibimos de nuestros clientes nos permite situarnos entre las principales marcas proveedoras de rodamientos del mundo.



Technical warranty

Garantía técnica



Fersa, as a manufacturer of high quality products, guarantees compliance with the highest standards relative to the use of the best steel quality in the production process, the highest standards in the design of contact surfaces, as well as the most efficient packaging and lubrication of parts.

The constant search for excellence in our processes allows us to offer a total warranty of the products in all the applications for which they were designed for.

One of our main objectives is the continued improvement in the quality of our products and processes, in pursuit of which we obtained ISO Certification 9001 in 1997, ISO 14001 in 2002 and ISO TS /16949:2002 in 2006.

Como fabricante de productos de alta calidad, Fersa asegura el cumplimiento de los estándares más exigentes en cuanto a la utilización de los mejores aceros en el proceso productivo, en el diseño estándar de las superficies de contacto así como en el correcto ensamblaje y lubricación de las piezas.

La búsqueda constante de la excelencia en nuestro proceso nos permite ofrecer una garantía total de nuestros productos en todas las aplicaciones para las que han sido diseñados.

Tenemos como uno de nuestros principales objetivos la mejora continua de nuestros productos y procesos, habiendo obtenido las certificaciones ISO 9001:2008 en 1997, ISO 14001:2004 en 2002 e ISO TS/16949:2009 en 2006.



00

Technical introduction

Introducción técnica

00.1 Introduction to Bearings / Introducción a los Rodamientos	16
00.2 Service life / Cálculo de vida	38
00.3 Sealing / Estanqueidad	40
00.4 Lubrication / Lubricación	46
00.5 Handling and Assembly / Manejo, Montaje y Funcionamiento	54
00.6 Failure diagnosis / Diagnóstico de defectología	58
00.7 Table of applications / Tabla de aplicaciones	72



00.1 Introduction to Bearings / Introducción a los Rodamientos

Definition

Bearings are vital machine components designed to allow rotation between two elements of a mechanism. They must be able to sustain the load coming from their own weight, and gear actions, belts, chains, etc., with minimum friction.

A bearing is generally composed of:

- Two rings, one linked to the fixed element, the other fitted to the mobile element, enabling rolling motion.
- Assembly of rolling elements, balls or rollers, that allow the displacement between the two rings.
- A cage maintaining separately the rolling elements.

A bearing can be classified in two main families:

- Those with punctual contact between rolling elements and rings, called ball bearings.
- Those with linear contact, called roller bearings.

Definición

Los rodamientos son componentes vitales de las máquinas, diseñados para facilitar el giro entre dos elementos de un mecanismo de la máquina en cuestión. Deben de soportar la carga generada por su propio peso, además de las acciones de engranajes, correas, cadenas, etc., con la mínima fricción posible.

En general un rodamiento se compone de:

- Dos aros, uno vinculado al elemento fijo, el otro unido al elemento móvil, para permitir el movimiento de rodadura.
- Un conjunto de los elementos rodantes, ya sean estos de bolas o rodillos, que permiten el desplazamiento entre los dos aros.
- Una jaula que mantiene los elementos rodantes separados.

Un rodamiento se clasifica en dos familias:

- Aquellos que tienen un contacto puntual entre los elementos rodantes y los aros, llamados rodamientos de bolas.
- Aquellos con un contacto lineal, llamados rodamientos de rodillos.

Features / Características



Ball bearings

- Most used
- Economic
- Simple design
- High speed limit
- Radial loads
- Axial loads on both sides
- Simple mantinance
- No disassembly

Rodamientos de bolas

- Más usado
- Económico
- Diseño simple
- Límite de alta velocidad
- Cargas radiales
- Cargas axiales en ambos sentidos
- Fácil mantenimiento
- No desmontaje



Tapered roller bearings

- Assembled in pairs
- Huge range
- Axial and radial loads
- Exchangeable rings
- Stiffness
- Low friction coefficient
- Roller alignment

Rodamientos cónicos

- Montaje por parejas
- Amplia gama
- Carga axial y radial
- Aros intercambiables
- Rigidez
- Bajo coeficiente de fricción
- Alineamiento



Cylindrical bearings

- Different designs
- High reliability
- Radial load only
- High speed
- Good for impact load
- Simple maintenance
- Easy lubrication

Rodamientos cilíndricos

- Diseños diversos
- Alta fiabilidad
- Solo carga radial
- Alta velocidad
- Buenos ante carga de impacto
- Fácil mantenimiento
- Fácil lubricación

Types of bearings / Tipos de rodamientos

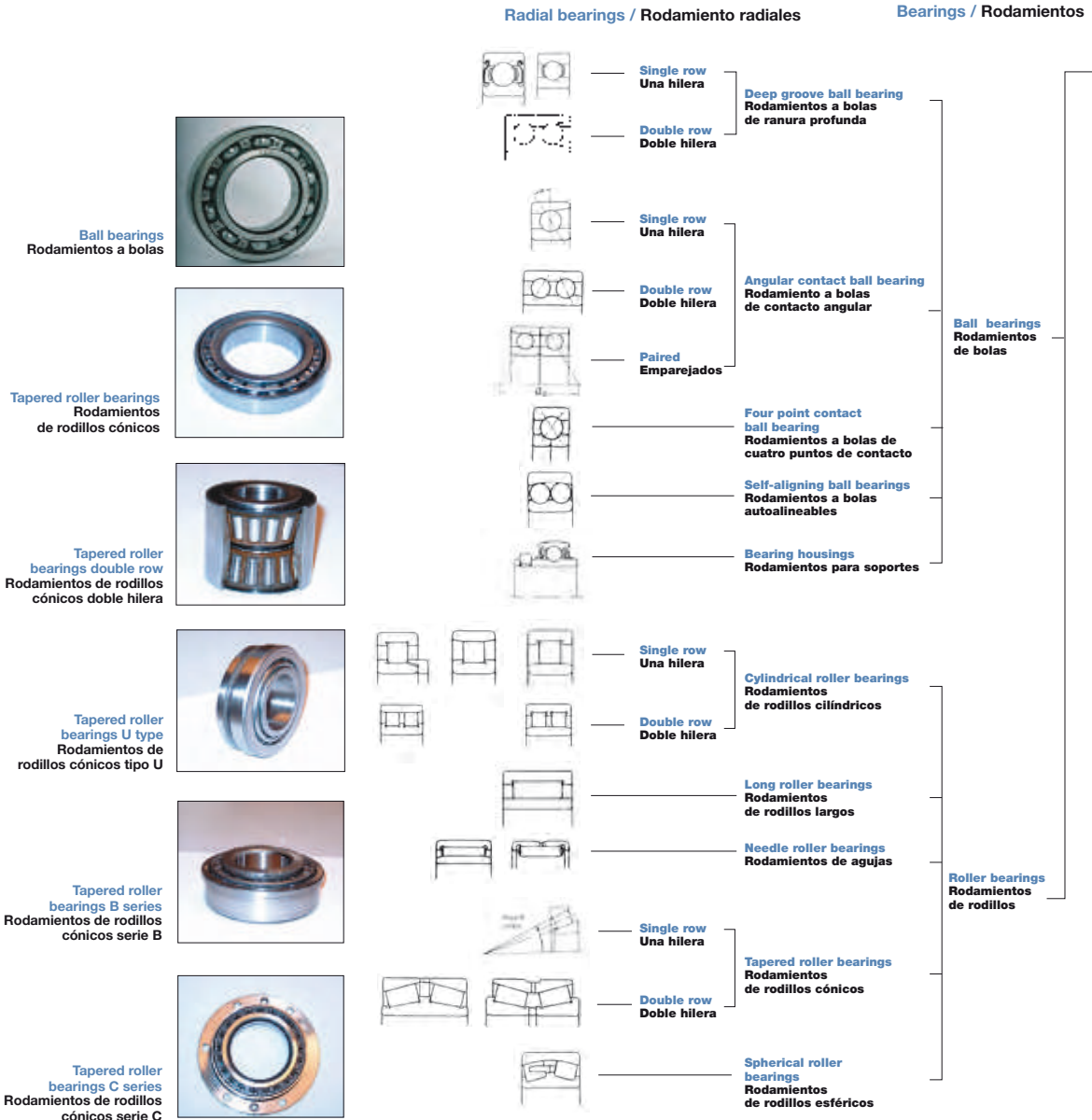

Thrust bearings / Rodamiento axiales

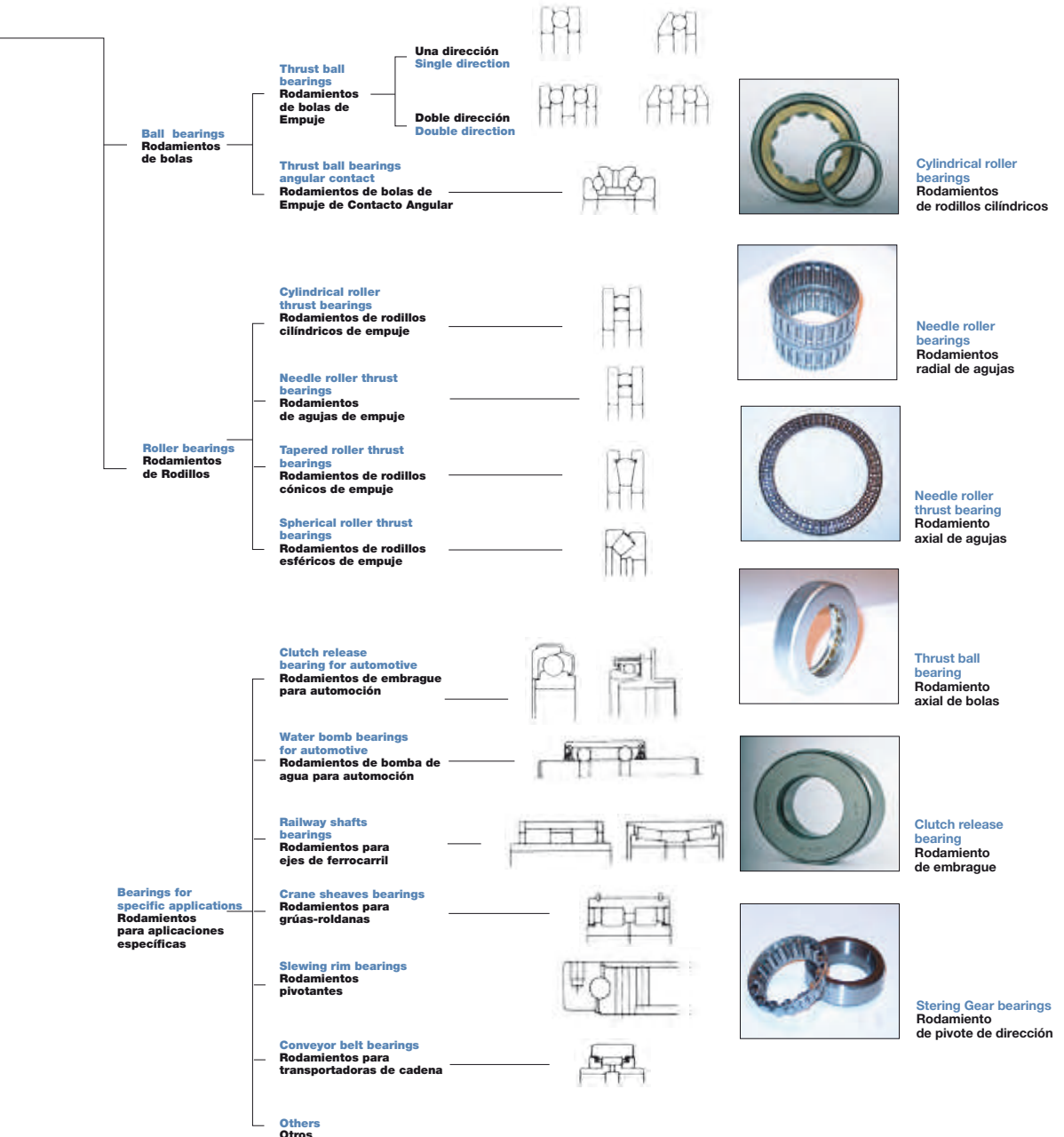

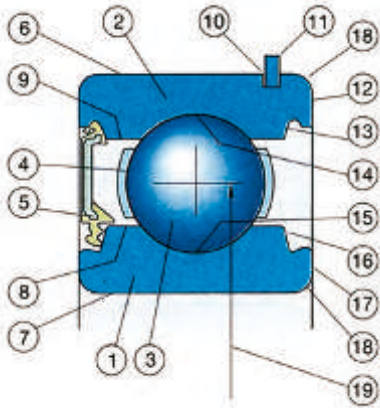
Bearing terminology / Terminología de rodamiento**Radial bearings (figs. 1 and 2)**

- 01. Inner ring
- 02. Outer ring
- 03. Rolling elements: balls, cylindrical rollers, tapered rollers, needle rollers, spherical rollers
- 04. Cage
- 05. Capping device: Seal made of elastomer, contacting (shown in figure) or non contacting shield made of sheet, non-contacting
- 06. Outer ring outside diameter
- 07. Inner ring bore
- 08. Inner ring shoulder diameter
- 09. Outer ring shoulder diameter
- 10. Snap ring groove
- 11. Snap ring
- 12. Outer ring side face
- 13. Seal anchorage groove
- 14. Outer ring raceway
- 15. Inner ring raceway
- 16. Sealing groove
- 17. Inner ring side face
- 18. Chamfer
- 19. Bearing mean diameter
- 20. Total bearing width
- 21. Guiding flange
- 22. Retaining flange

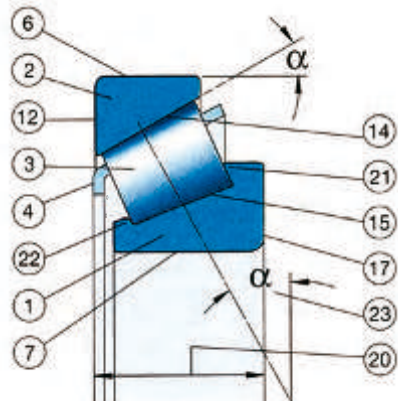
**Rodamientos radiales (figs. 1 y 2)**

- 01. Aro interior
- 02. Aro exterior
- 03. Elementos rodantes : bolas, rodillos cilíndricos , rodillos cónicos, agujas, rodillos esféricos
- 04. Jaula
- 05. Mecanismo de cierre: Retén (fabricado de elastómeros, rozantes como muestra la figura o no rozantes), Escudo (fabricado con chapa de acero y no rozante)
- 06. Diámetro exterior del aro exterior
- 07. Agujero del aro interior
- 08. Diámetro de apoyo del aro interior
- 09. Diámetro de apoyo del aro exterior
- 10. Ranura para anillo elástico
- 11. Anillo elástico
- 12. Cara del aro exterior
- 13. Ranura de anclaje del retén
- 14. Camino de rodadura del aro exterior
- 15. Camino de rodadura del aro interior
- 16. Ranura de sellado
- 17. Cara del aro interior
- 18. Radio
- 19. Diámetro medio del rodamiento
- 20. Altura total del rodamiento
- 21. (Pestaña / testa) guía
- 22. (Pestaña / testa) retén

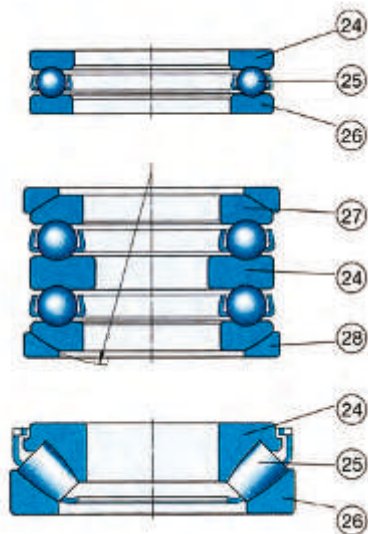

Thrust bearings (fig. 3)

- 24. Shaft washer
- 25. Rolling element and cage assembly
- 26. Housing washer
- 27. Housing washer with sphered seating surface
- 28. Seating support washer

Rodamientos axiales (figs. 3)

- 24. Arandela del eje
- 25. Elementos rodantes y montaje de jaula
- 26. Arandela del alojamiento
- 27. Arandela del alojamiento con superficie de asiento esférica
- 28. Arandela soporte de asiento

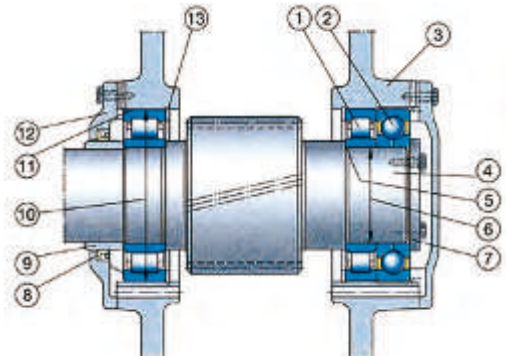

Bearing arrangement (fig. 4)

- 01. Cylindrical roller bearing
- 02. Four-point contact ball bearing
- 03. Housing
- 04. Shaft
- 05. Shaft abutment shoulder
- 06. Shaft diameter
- 07. Locking plate
- 08. Radial shaft seal
- 09. Distance ring
- 10. Housing bore diameter
- 11. Housing bore
- 12. Housing cover
- 13. Snap ring

Montaje del rodamiento (fig. 4)

- 01. Rodamiento de rodillos cilíndricos
- 02. Rodamiento de bolas con 4 puntos de contacto
- 03. Alojamiento
- 04. Eje
- 05. Apoyo frontal del eje
- 06. Diámetro del eje
- 07. Tapa de bloqueo
- 08. Retén radial del eje
- 09. Aro distanciador
- 10. Diámetro del alojamiento
- 11. Agujero del alojamiento
- 12. Tapa del alojamiento
- 13. Anillo elástico

Bearing Nomenclature

A nomenclature has been established to facilitate identification and recognition of a bearing and corresponding characteristics.

Nomenclatura de rodamientos

Con el fin de nombrar y luego reconocer un rodamiento según sus propiedades, se ha establecido una nomenclatura.

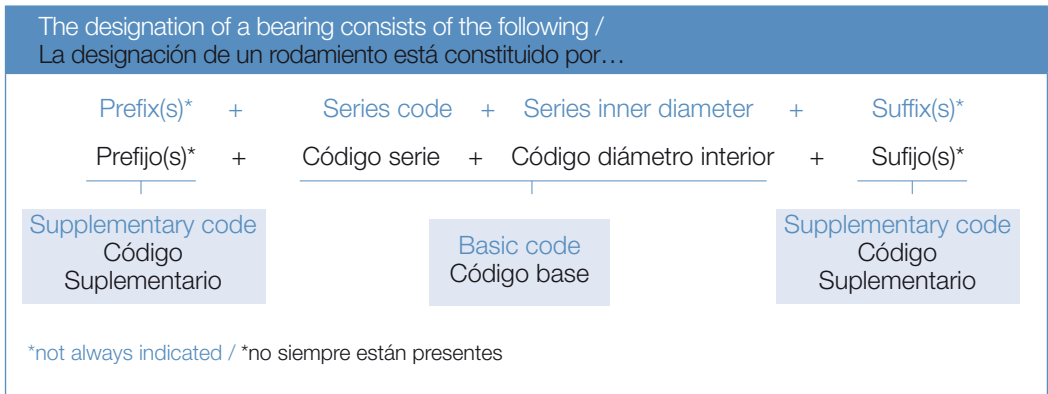

First character of basic code

6	Single row deep groove ball bearings
4	Double row deep groove ball bearing
7	Single row angular contact ball bearing
3	Double row angular contact ball bearing
1	Self-aligning ball bearing
N	Cylindrical roller bearing
3	Single row taper roller bearing
2	Spherical roller bearing
5	Thrust ball bearing
29	Thrust tapered roller bearing

Primer carácter del código base

6	Rodamientos de bolas de una hilera
4	Rodamientos de doble hilera
7	Rodamientos de bolas de contacto angular de una hilera
3	Rodamientos de bolas de contacto angular de doble hilera
1	Rodamientos de bolas auto-alienantes
N	Rodamientos de rodillos cilíndricos
3	Rodamientos de rodillos cónicos de una hilera
2	Rodamientos de rodillos esféricos
5	Rodamientos de bolas axiales
29	Rodamientos de rodillos cónicos axiales

Second and third characters of basic code

The second (and third) number of the symbol represents the width and exterior diameter of the corresponding bearing.

Segundo y tercer carácter del código base

La segunda (y tercera) cifra del símbolo representa la anchura y el diámetro exterior del rodamiento respectivamente.

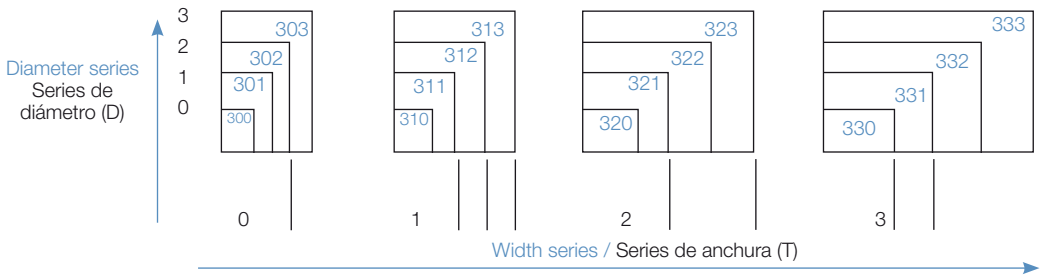

3 cases according to inner diameter size / 3 casos según el tamaño del diámetro interior

<p>Inner diameter Less than 10 mm Diámetro interior Inferior a 10 mm</p> <p>The last number of the symbol is the internal diameter La última cifra del símbolo es el diámetro interior...</p> <ul style="list-style-type: none"> • 604 inner diameter 4 mm / 604 diámetro interior 4 mm • 629 inner diameter 9 mm / 629 diámetro interior 9 mm 	<p>Inner diameter between 10 – 17 mm Diámetro interior entre 10 y 17 mm</p> <p>codes are defined, Los códigos están definidos, 00 = 10 mm 01 = 12 mm 02 = 15 mm 03 = 17 mm</p> <ul style="list-style-type: none"> • 6000 inner diameter 10 mm / 6000 diámetro interior 10 mm • 6203 inner diameter 17 mm / 6203 diámetro interior 17 mm 	<p>Inner diameter over 20 mm Diámetro interior Superior a 20 mm</p> <p>multiply code of internal diameter by 5 Multiplicar el código del diámetro interior por 5</p> <ul style="list-style-type: none"> • 6204 inner diameter 4x5 = 20 mm / 6204 diámetro interior 4x5 = 20 mm • 4206 inner diameter 6x5 = 30 mm / 4206 diámetro interior 6x5 = 30 mm
--	---	---

Codes for the inner diameter (the last two characters)

Códigos de diámetro interior (dos últimos caracteres)

Num	Ød(mm)	Num	Ød(mm)	Num	Ød(mm)	Num	Ød(mm)	Num	Ød(mm)	Num	Ød(mm)
1	1	00	10	/32	32	15	75	26	130	48	240
2	2	01	12	07	35	16	80	28	140	52	260
3	3	02	15	08	40	17	85	30	150	56	280
4	4	03	17	09	45	18	90	32	160	60	300
5	5	04	20	10	50	19	95	34	170	64	320
6	6	/22	22	11	55	20	100	36	180	68	340
7	7	05	25	12	60	21	105	38	190		
8	8	/28	28	13	65	22	110	40	200		
9	9	06	30	14	70	24	120	44	220		

Tolerances

Two different sort of tolerances can be applied when talking about bearings:

- Dimensional tolerances, applicable to the main bearing dimensions and the environment assembly.
- Operational tolerances, concerning rotation precision.

The standards defining the dimensional tolerances are:

- ISO 492, that fixes tolerances with regards to the diameter, width and height. Also, NORMAL class and Precision class can be distinguished.
- ISO 582, that states tolerances of the bearing environment, for instance, fillet radius.

Tolerancias

Hay dos tipos de tolerancias aplicadas a rodamientos:

- Tolerancias dimensionales aplicadas a las principales dimensiones de rodamientos y al entorno del montaje.
- Tolerancias de funcionamiento, en relación a la precisión de giro.

Las normas que definen las tolerancias dimensionales son:

- La Normativa ISO 492 regula las tolerancias de acuerdo al diámetro, altura, y anchura. Se puede distinguir entre clase NORMAL y clase Precisión.
- La Normativa ISO 582 regula las tolerancias del entorno del rodamiento, por ejemplo el radio del chaflán.

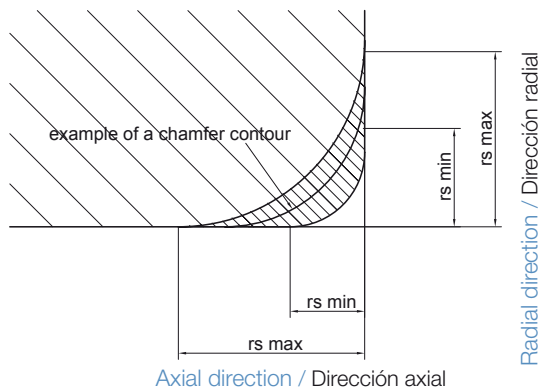

**Tapered roller bearings inner and outer ring back faces /
Tolerancias del chaflán en cara ancha de aros y conos**

Metric series / Series métricas
According ISO 582 / Según ISO 582

Dimensions in millimetres / Dimensiones en milímetros

rs min 1)	d or D	rs max	
		Dirección / Directions	
		radial	axial
0,3	d or D ≤ 40	0,7	1,4
	d or D > 40	0,9	1,6
0,6	d or D ≤ 40	1,1	1,7
	d or D > 40	1,3	2
1	d or D > 50	1,6	2,5
	d or D > 50	1,9	3
1,5	d or D ≤ 120	2,3	3
	120 < d (or D) ≤ 250	2,8	3,5
	d or D > 250	3,5	4
2	d or D ≤ 120	2,8	4
	120 < d (or D) ≤ 250	3,5	4,5
	d or D > 250	4	5
2,5	d or D ≤ 120	3,5	5
	120 < d (or D) ≤ 250	4	5,5
	d or D > 250	4,5	6
3	d or D ≤ 120	4	5,5
	120 < d (or D) ≤ 250	4,5	6,5
	250 < d (or D) ≤ 400	5	7
	d or D > 400	5,5	7,5
4	d or D ≤ 120	5	7
	120 < d (or D) ≤ 250	5,5	7,5
	250 < d (or D) ≤ 400	6	8
	d or D > 400	6,5	8,5
5	d or D ≤ 180	6,5	8
	d or D > 180	7,5	9
6	d or D ≤ 180	7,5	10
	d or D > 180	9	11

Inch series / Series pulgadas
**According ANSI / ABMA std 19.2 /
Según ANSI / ABMA std 19.2**

D		h ₂		g ₂	
From/ Desde	To/ Hasta	Min	Max	Min	Max
-	101,6	r ₂	r ₂ +0,58	r ₂	r ₂ +1,07
101,6	168,275	r ₂	r ₂ +0,64	r ₂	r ₂ +1,17
168,275	266,7	r ₂	r ₂ +0,84	r ₂	r ₂ +1,35

d		h ₁		g ₁	
From/ Desde	To/ Hasta	Min	Max	Min	Max
-	50,8	r ₁	r+0,38	r ₁	r+0,89
50,8	101,6	r ₁	r+0,51	r ₁	r+1,27
101,6	254	r ₁	r+0,64	r ₁	r+1,78

Tolerance measuring method / Métodos de medida de tolerancias

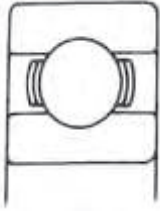

Bore diameter (d) Cylindrical bore bearings

The maximum value ($d_{s_{pmax}}$) and the minimum value ($d_{s_{pmin}}$) of the bore diameter (d_s) radial plane is obtained
The single plane mean bore diameter (d_{mp}) is obtained as the arithmetic mean value of the maximum value ($d_{s_{pmax}}$) and minimum values ($d_{s_{pmin}}$)

$$d_{mp} = \frac{d_{s_{pmax}} + d_{s_{pmin}}}{2}$$

- Single plane mean bore diameter deviation
 $\Delta_{d_{mp}} = d_{mp} - d$
- Bore diameter variation in a single radial plane
 $V_{dp} = d_{s_{pmax}} - d_{s_{pmin}}$
- Mean bore diameter variation
 $V_{d_{mp}} = d_{mp_{max}} - d_{mp_{min}}$
- Deviation of a single bore diameter $\Delta_{d_s} = d_s - d$

Diámetro de agujero (d) para Rodamientos de agujero cilíndrico

Obtiene el máximo valor ($d_{s_{pmax}}$) y el mínimo valor ($d_{s_{pmin}}$) del diámetro de agujero (d_s) tomado en un plano radial simple

Se obtiene el diámetro de agujero medio (d_{mp}) como la media aritmética del máximo valor ($d_{s_{pmax}}$) y el mínimo valor ($d_{s_{pmin}}$)

$$d_{mp} = \frac{d_{s_{pmax}} + d_{s_{pmin}}}{2}$$

- Desviación del diámetro de agujero medio en un plano $\Delta_{d_{mp}} = d_{mp} - d$
- Variación del diámetro de agujero en un plano radial
 $V_{dp} = d_{s_{pmax}} - d_{s_{pmin}}$
- Variación del diámetro medio de agujero
 $V_{d_{mp}} = d_{mp_{max}} - d_{mp_{min}}$
- Desviación de un diámetro de agujero $\Delta_{d_s} = d_s - d$

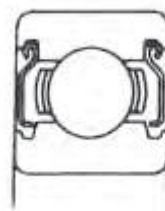

Bore diameter (d) Tapered bore bearings

Bore diameter at the theoretical small end and bore diameter at the theoretical large end

$$d_s = \frac{d_{bs}}{h_a - h_b} \frac{h_a - d_{as}}{h_b} \quad d_{1s} = \frac{d_{as}(B - h_b) - d_{bs}(B - h_a)}{h_a - h_b}$$

- Single plane mean bore diameter deviation at the theoretical small end $V_{d_{mp}} = d_{mp_{max}} - d_{mp_{min}}$
- Deviation on taper $(\Delta_{1mp} - \Delta_{1mp}) = (d_{1mp} - d_1) - (d_{mp} - d)$
- Bore diameter variation in a single radial plane
 $V_{dp} = d_{s_{pmax}} - d_{s_{pmin}}$

Diámetro de agujero (d) para Rodamientos de agujero cónico

Diámetro de agujero en el teórico menor diámetro y diámetro de agujero en el teórico mayor diámetro

$$d_s = \frac{d_{bs}}{h_a - h_b} \frac{h_a - d_{as}}{h_b} \quad d_{1s} = \frac{d_{as}(B - h_b) - d_{bs}(B - h_a)}{h_a - h_b}$$

- Desviación entre el diámetro medio de agujero en un plano simple y el teórico menor diámetro
 $V_{d_{mp}} = d_{mp_{max}} - d_{mp_{min}}$
- Desviación en ángulo $(\Delta_{1mp} - \Delta_{1mp}) = (d_{1mp} - d_1) - (d_{mp} - d)$
- Variación del diámetro de agujero en un plano radial simple $V_{dp} = d_{s_{pmax}} - d_{s_{pmin}}$

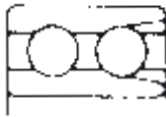

Outside diameter (D)

Obtain the single plane mean outside diameter (D_{mp}) as the arithmetical mean value of the maximum value (D_{spmax}) and the minimum value (D_{spmin}) of the bearing outside diameters (D_s) acquired in a single radial plane

$$D_{mp} = \frac{D_{spmax} - D_{spmin}}{2}$$

- Single plane mean outside diameter deviation $\Delta_{Dmp} = D_{mp} - D$
- Outside diameter variation in a single radial plane $V_{Dp} = D_{spmax} - D_{spmin}$
- Mean outside diameter variation $V_{Dmp} = D_{mpmax} - D_{mpmin}$
- Deviation of a single outside diameter $r\Delta_{Ds} = D_s - D$

Diámetro exterior (D)

Obtiene el diámetro exterior medio en un plano simple (D_{mp}) como la media aritmética del máximo valor (D_{spmax}) y el mínimo valor (D_{spmin}) de los diámetros exteriores del rodamiento (D_s) tomados en un plano radial simple

$$D_{mp} = \frac{D_{spmax} - D_{spmin}}{2}$$

- Desviación del diámetro exterior medio en un plano $\Delta_{Dmp} = D_{mp} - D$
- Variación del diámetro exterior en un plano radial $V_{Dp} = D_{spmax} - D_{spmin}$
- Variación del diámetro exterior medio $V_{Dmp} = D_{mpmax} - D_{mpmin}$
- Desviación del diámetro exterior $r\Delta_{Ds} = D_s - D$

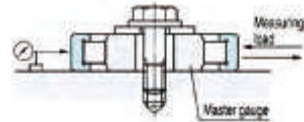

Roller set bore diameter (Fw)

Deviation of the roller set bore diameter

$$\Delta_{Fw} = (d_G + \delta_{1m}) - F_w$$

Deviation of the minimum diameter of the roller set bore diameter

$$\Delta_{Fwmin} = (d_G + \delta_{1m}) - F_w$$

(d_G): Outside diameter of the master gauge

(δ_{1m}): Arithmetical mean value of the amount of movement of the outer ring

(δ_{1min}): Minimum value of the amount of movement of the outer ring

Diámetro del agujero con un set de rodillos (Fw)

Desviación del diámetro de agujero con un set de rodillos $\Delta_{Fw} = (d_G + \delta_{1m}) - F_w$

Desviación del diámetro mínimo del agujero con set de rodillos $\Delta_{Fwmin} = (d_G + \delta_{1m}) - F_w$

(d_G): Diámetro exterior del calibre patrón

(δ_{1m}): Valor medio aritmético del incremento de movimiento del aro exterior

(δ_{1min}): Mínimo valor del incremento de movimiento del aro exterior

Tolerance measuring method / Métodos de medida de tolerancias

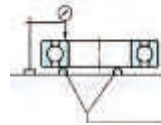
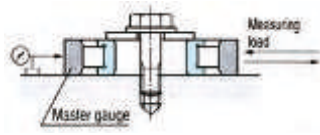

Ring supports
(3 places on circumference)
Soportes para el aro
(3 puntos en la circunferencia)

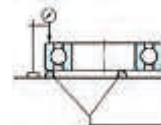

Ring supports
(3 places on circumference)
Soportes para el aro
(3 puntos en la circunferencia)

Roller set outside diameter (E_w)

Deviation of the roller set outside diameter

$$\Delta_{E_w} = (D_G + \delta_{2m'}) - E_w$$

(D_G): Bore diameter of the master gauge

($\delta_{2m'}$): Arithmetical mean value of the amount of movement of the master gauge

Inner ring width (B) and outer ring width (C)

Deviation of a single inner ring width $\Delta_{B_s} = B_s - B$

Inner ring width variation $V_{B_s} = B_{s \max} - B_{s \min}$

Deviation of a single outer ring width $\Delta_{C_s} = C_s - C$

Outer ring width variation $V_{C_s} = C_{s \max} - C_{s \min}$

Diámetro exterior con un set de rodillos (E_w)

Desviación del diámetro exterior con un set de rodillos

$$\Delta_{E_w} = (D_G + \delta_{2m'}) - E_w$$

(D_G): Diámetro del agujero del calibre patrón

($\delta_{2m'}$): Valor medio aritmético del incremento de movimiento del calibre patrón

Altura del aro interior (B) y del aro exterior (C)

Desviación de altura en un aro interior simple

$$\Delta_{B_s} = B_s - B$$

Variación de altura del aro interior $V_{B_s} = B_{s \max} - B_{s \min}$

Desviación de altura en un aro exterior simple

$$\Delta_{C_s} = C_s - C$$

Variación de altura del aro exterior $V_{C_s} = C_{s \max} - C_{s \min}$

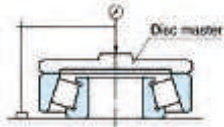

Bearing width of tapered roller bearing (T)

Deviation of the actual bearing width $\Delta_{T_s} = T_s - T$

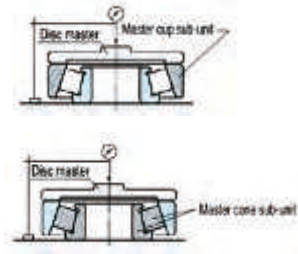

Effective width of tapered roller bearing (T_1, T_2)

Deviation of the actual effective width of cone sub-unit
 $t\Delta_{T_{1s}} = T_{1s} - T_1$

Deviation of the actual effective width of cup sub-unit
 $\Delta_{T_{2s}} = T_{2s} - T_2$

Altura de un rodamiento de rodillos cónicos (T)

Desviación de la altura del rodamiento $\Delta_{T_s} = T_s - T$

Altura efectiva de un rodamiento de rodillos cónicos (T_1, T_2)

Desviación de la altura efectiva con conjunto interior y aro exterior patrón $t\Delta_{T_{1s}} = T_{1s} - T_1$

Desviación de la altura efectiva con aro exterior y conjunto interior patrón $\Delta_{T_{2s}} = T_{2s} - T_2$

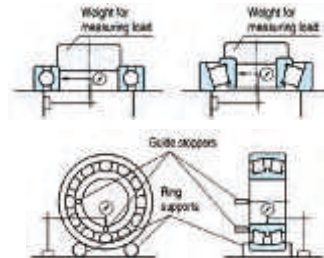
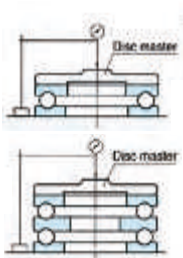
Tolerance measuring method / Métodos de medida de tolerancias**Height of thrust ball bearing with flat back face (T, T₁)**

Deviation of the actual bearing height $\Delta_{T_s} = T_s - T$

(single direction) $\Delta_{T_{1s}} = T_{1s} - T_1$
(double direction)

Radial runout of assembled bearing inner ring (K_{ia})

The radial runout of the inner ring/cone (K_{ia}) shall be obtained as the difference between the maximum value and the minimum value of the readings of the measuring instrument, when the inner ring/cone has been rotated through one rotation.

Note: The measurement of the radial runout of the inner ring of cylindrical roller bearings, machined ring needle roller bearings, self-aligning ball bearings and spherical roller bearings shall be carried out by fixing the outer ring with ring supports.

Altura de un rodamiento axial de bolas con la cara inferior apoyada (T, T₁)

Desviación de la altura del rodamiento $\Delta_{T_s} = T_s - T$

(dirección simple) $\Delta_{T_{1s}} = T_{1s} - T_1$
(dirección doble)

Salto radial del aro interior del rodamiento montado (K_{ia})

El salto radial del aro interior (K_{ia}) se obtiene como la diferencia entre el máximo valor y el mínimo valor leídos en el instrumento de medida, cuando el aro interior ha sido girado durante una vuelta.

Nota: La medida del salto radial del aro interior de rodamientos de rodillo cilíndrico, rodamientos de agujas, rodamientos de bolas autoalineables y rodamientos de rodillos esféricos pueden medirse fijando el aro exterior con soportes para el aro exterior.

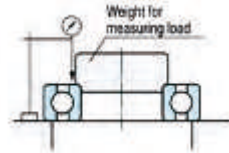
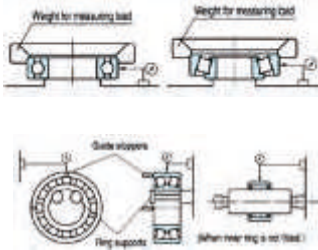

Radial runout of assembled bearing outer ring (K_{oa})

The measurement of outer ring/cup runout (K_{oa}) shall be obtained as the difference between the maximum value and the minimum value of the readings of the measuring instrument, when the outer ring/cup has been rotated through one rotation.

Note: The measurement of the radial runout of the outer ring of cylindrical roller bearings, machined ring needle roller bearings, self-aligning ball bearings and spherical roller bearings shall be carried out by fixing the inner ring with ring supports.

Assembled bearing inner ring face (cone back face) runout with raceway (S_{ia})

The axial runout of the inner ring/cone (S_{ia}) shall be obtained as the difference between the maximum value and the minimum value of the readings of the measuring instrument, when the inner ring/cone has been rotated through one rotation.

Salto radial del aro exterior del rodamiento montado (K_{oa})

El salto radial del aro exterior (K_{oa}) se obtiene como la diferencia entre el máximo valor y el mínimo valor leídos en el instrumento de medida, cuando el aro exterior ha sido girado durante una vuelta.

Nota: La medida del salto radial del aro exterior de rodamientos de rodillo cilíndrico, rodamientos de agujas, rodamientos de bolas autoalineables y rodamientos de rodillos esféricos pueden medirse fijando el aro interior con soportes para el aro interior.

Salto axial de la cara del aro interior con la pista del rodamiento montado (S_{ia})

La medida del salto axial del aro interior (S_{ia}) se obtiene como la diferencia entre el máximo valor y el mínimo valor leídos en el instrumento de medida, cuando el aro interior ha sido girado durante una vuelta.

Tolerance measuring method / Métodos de medida de tolerancias

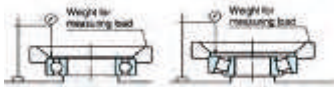

Assembled bearing outer ring face (cup back face) runout with raceway (S_{ea})

The axial runout of the outer ring/cup (S_{ea}) shall be obtained as the difference between the maximum value and the minimum value of the readings of the measuring instrument, when the outer ring/cup has been rotated through one rotation.

Salto axial de la cara del aro exterior con la pista del rodamiento montado (S_{ea})

La medida del salto axial del aro exterior (S_{ea}) se obtiene como la diferencia entre el máximo valor y el mínimo valor leídos en el instrumento de medida, cuando el aro exterior ha sido girado durante una vuelta.

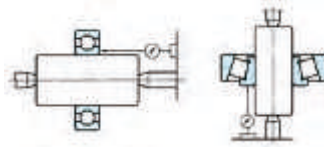

Face runout with bore (S_{fj})

The face runout of the inner ring/cone (S_{fj}) shall be obtained as the difference between the maximum value and the minimum value of the readings of the measuring instrument, when the inner ring/cone has been rotated through one rotation with the tapered arbor.

Salto lateral de la cara con relación al agujero (S_{fj})

La medida del salto de la cara del aro interior (S_{fj}) se obtiene como la diferencia entre el máximo valor y el mínimo valor leídos en el instrumento de medida, cuando el aro interior ha sido girado durante una vuelta con el eje cónico.

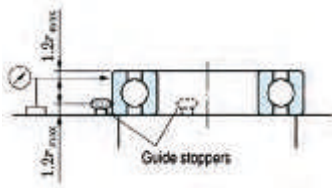

Variation of outside surface generatrix inclination with face (S_D)

The outside surface generatrix inclination with face (S_D) shall be obtained as the difference between the maximum value and the minimum value of the readings of the measuring instrument, when the outer ring has been rotated through one rotation along the guide stopper.

Variación de la inclinación de la superficie exterior con relación a la cara (S_D)

La medida de la variación de la inclinación de la superficie exterior con relación a la cara (S_D) se obtiene como la diferencia entre el máximo valor y el mínimo valor leídos en el instrumento de medida, cuando el aro exterior ha sido girado durante una vuelta apoyando en los topes de guía.

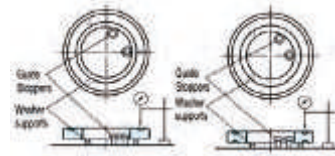

Shaft/central washer raceway to back face thickness variation of thrust ball bearing with flat back face (S)

The measurement of the thickness variation (S) of shaft washer raceway track shall be obtained as the difference between the maximum value and the minimum value of the readings of the measuring instrument, when the shaft washer has been rotated through one rotation along the guide stopper. For the central washer, carry out the same measurement for the two raceway grooves to obtain the thickness variation of the raceway track.

Variación del espesor del aro del eje entre el centro del camino de rodadura y la cara opuesta (S)

La medida de la variación de espesor (S) del aro del eje entre el centro del camino de rodadura y la cara opuesta, se obtiene como la diferencia entre el máximo valor y el mínimo valor leídos en el instrumento de medida, cuando el aro del eje ha sido girado durante una vuelta apoyando en los topes de guía. Para el aro central, se utiliza el mismo método para los dos caminos de rodadura obteniendo la variación de espesor del camino.

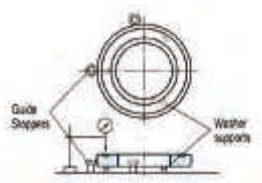

Housing washer raceway to back face thickness variation of thrust ball bearing with flat back face (S_e)

The measurement of the thickness variation (S_e) of housing washer raceway track shall be obtained as the difference between the maximum value and the minimum value of the readings of the measuring instrument, when the housing washer has been rotated through one rotation along the guide stopper.

Variación del espesor del aro del alojamiento entre el centro del camino de rodadura y la cara opuesta (S_e)

La medida de la variación de espesor (S_e) del aro del alojamiento entre el centro del camino de rodadura y la cara opuesta, se obtiene como la diferencia entre el máximo valor y el mínimo valor leídos en el instrumento de medida, cuando el aro del alojamiento ha sido girado durante una vuelta apoyando en los topes de guía.

Internal clearance

Depending on the application it may be necessary to have either a positive (internal clearance) or a negative (preload) operational clearance in the bearing arrangement.

Bearing internal clearance is defined as the total distance through which one bearing ring can be moved relative to the other in the radial direction (radial internal clearance) or in the axial direction (axial internal clearance).

Values of clearance have been defined in clearance groups as follows, starting from the smallest:

$C1 < C2 < \text{Normal} < C3 < C4 < C5$

Misalignment

The bearing raceways should be perfectly aligned if we are looking for a good performance and life of the bearing. Unfortunately, there is always a certain amount of misalignment in every application.

Misalignment produces a non uniform stress distribution along the roller-raceways contacts shifting the stress profile towards one end of the contact length.

Speed

The speed of a bearing fitted in an application is determined by several factors:

- Working temperature.
- Adjustment of the assembly.
- Lubrication.
- Bearing design.
- Cooling conditions.

Juego radial interno

Dependiendo de la aplicación se necesitará un juego interno de funcionamiento positivo (juego radial) o negativo (pre carga) en el montaje de rodamiento.

El juego interno de un rodamiento se define como la distancia total a través de la cual el aro de rodamiento puede moverse en relación al otro en la dirección radial (juego interno radial) o en la dirección axial (juego interno axial).

Los valores de juego se clasifican en grupos, según se detalla más abajo, empezando por el más pequeño:

$C1 < C2 < \text{Normal} < C3 < C4 < C5$

Desalineación

Las pistas de rodamientos deben de estar perfectamente alineadas si se requiere un buen funcionamiento y una elevada durabilidad. Sin embargo se ha de tener en cuenta que en toda aplicación existe algo de desalineación.

La desalineación produce una distribución no uniforme de esfuerzos a lo largo de la pista de rodadura, desplazando las tensiones hacia los extremos de la longitud del contacto.

Velocidad

Hay varios factores determinantes de la velocidad de un rodamiento ensamblado en una aplicación:

- Temperatura de funcionamiento.
- Ajuste del montaje.
- Lubricación.
- Diseño del rodamiento.
- Condiciones de disipación del calor.

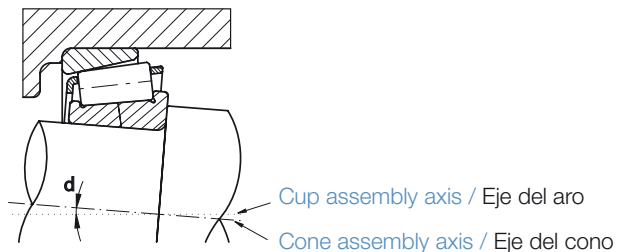

Bearing speed can be expressed as:

a) Thermal reference speed.

It is the permissible operational speed of a bearing subjected to a certain load and running with a certain lubricant viscosity according to the ISO 15312. In these specific conditions, there is an equilibrium between the heat that is generated by the bearing and the heat that is dissipated from the bearing to the shaft, housing and lubricant.

b) Limiting speed.

The speed limit is based on practical experience and laboratory tests that takes into account the strength of the cage, lubrication, sealing function and centrifugal forces.

Fitting Tolerances

Housings:

The tolerance zone is defined as a spherical zone limited by the upper and lower limit dimensions of the part. The tolerance zone is therefore determined by the amount of tolerance and its position related to the basic size. The position of the tolerance zone, related to the basic size (zero line), is determined in the ISO system by a so-called basic deviation. The system ISO defines 28 classes of basic deviations for holes. These classes are marked by capital letters (A, B, C ... ZC). The tolerance zone for the specified dimensions is prescribed in the drawing by a tolerance mark, which consists of a letter marking of the basic deviation and a numerical marking of the tolerance grade (e.g. H7, H8, D5, etc.).

Shafts:

The tolerance zone is defined as a spherical zone limited by the upper and lower limit dimensions of the parts. The tolerance zone is therefore determined by the amount of tolerance and its position related to the basic size. The position of the tolerance zone, related to the basic size (zero line), is determined in the ISO system by a so-called basic deviation. The system ISO defines 28 classes of basic deviations for shafts. These classes are marked by lower case letters (a, b, c... zc). The tolerance zone for the specified dimensions is prescribed in the drawing by a tolerance mark, which consists of a letter marking the of the basic deviation and a numerical marking the tolerance grade (e.g. h7, h6, g5, etc.).

La velocidad de los rodamientos se expresan de la siguiente manera:

a) Velocidad de referencia térmica.

Es la velocidad de funcionamiento permitida de un rodamiento sometido a una carga determinada que funciona con una viscosidad de lubricante determinada de acuerdo a las Normas ISO 15312. En estas condiciones específicas hay un equilibrio entre el calor generado por el rodamiento y el calor que se disipa del rodamiento al eje, caja y lubricante.

b) Velocidad límite.

La velocidad límite se basa en la experiencia práctica y en las pruebas de laboratorio que toman en cuenta la resistencia de la jaula, lubricación, la estanqueidad y las fuerzas centrífugas.

Tolerancias de Montaje

Alojamientos:

La zona de tolerancia se define como una zona esférica limitada por los valores máximos y mínimos de una dimensión. Se determina según el valor de la misma y su posición en relación al valor nominal. La posición de la zona de tolerancia, relacionada al valor nominal o básico (línea cero), se determina en el sistema ISO por la llamada desviación básica. El sistema ISO define 28 clases de desviación básica para los agujeros. Estas clases se identifican con letras (A, B, C... ZC). La zona de tolerancia para una dimensión específica se define en el dibujo por una marca de tolerancia, consistente en una letra de la desviación básica y de un número del grado de tolerancia (p.ej. H7, H8, D5, etc.).

Ejes:

La zona de tolerancia se define como una zona esférica limitada por los valores máximos y mínimos de una dimensión. Se determina según el valor de la misma y su posición en relación al valor nominal.

La posición de la zona de tolerancia, relacionada al valor nominal o básico (línea cero), se determina en el sistema ISO por la llamada desviación básica. El sistema ISO define 28 clases de desviación básica para los ejes. Estas clases se identifican por letras en minúsculas (a, b, c... zc). La zona de tolerancia para una dimensión específica se define en el dibujo por una marca de tolerancia, consistente en una letra de la desviación básica y un número del grado de tolerancia (p.ej. h7, h6, g5, etc.).

00.2 Service Life / Cálculo de Vida

If the bearings are used in ideal operating conditions, their service life is determined by metal fatigue, which means that the term "life" is the service period time limited by the phenomena of fatigue.

In tapered roller bearings that have operated under clean and well lubricated conditions, as a consequence of surface stress cycles, the symptom of the end of their service life will be the appearance of pits on the surface.

Seeing as fatigue is a statistical phenomenon, the service life cannot be precisely determined, and is expressed as the number of revolutions that 90% of a group of similar bearing will surpass before spalling and flaking problems appear on the surfaces. The practical determination of the service life for tapered roller bearings is calculated using the formula:

$$L_{10} = (C_r/P_r)^{10/3}$$

Where L_{10} = nominal service life in millions of revolutions, C_r = radial dynamic load in Newton, P_r = equivalent radial load in Newton.

For certain applications, it may be desirable to calculate the service life adjusted to other levels of reliability, for which the following formula is used:

$$L_{na} = a_1 \times a_2 \times a_3 \times L_{10}$$

Where L_{na} = service life adjusted to the characteristics of the material and non-conventional operating conditions and for a reliability of $(100-n)\%$ in millions of revolutions, a_1 = correction factor as a function of reliability, a_2 = correction factor as a function of material, a_3 = correction factor as a function of lubrication and environment.

Si los rodamientos son utilizados en condiciones ideales de operación, su duración está determinada por la fatiga del material, por lo tanto el término "vida" será el período de servicio limitado por los fenómenos de fatiga.

En los rodamientos de rodillos cónicos, que han funcionado en buenas condiciones de limpieza y lubricación, debido a los ciclos de tensión superficial, el síntoma del fin de la vida de servicio, será la aparición de unas marcas o picaduras en dichas superficies de rodadura.

Como la fatiga es un fenómeno estadístico, la duración de funcionamiento no se puede predecir exactamente y dicha duración se expresa como el n° de revoluciones que 90% de un grupo de rodamientos iguales llegarán a superar, antes de que aparezcan problemas de exfoliación en las superficies de rodadura.

La determinación práctica de la vida útil para un rodamiento de rodillos cónicos se calcula mediante la fórmula:

$$L_{10} = (C_r/P_r)^{10/3}$$

Donde L_{10} = vida útil nominal, en millones de revoluciones, C_r = Carga dinámica radial, en Newtons, P_r = Carga dinámica equivalente radial en Newtons.

Para ciertas aplicaciones puede ser deseable calcular la vida útil, pero ajustada a otros niveles de fiabilidad, para lo cual utilizaríamos la siguiente fórmula:

$$L_{na} = a_1 \times a_2 \times a_3 \times L_{10}$$

Donde L_{na} = vida útil ajustada para características del material y condiciones de funcionamiento no convencionales y para una fiabilidad del $(100-n)\%$ en millones de revoluciones, a_1 = factor de corrección en función de la fiabilidad, a_2 = factor de corrección en función del material, a_3 = factor de corrección en función de la lubricación y ambiente.

Load capacities

The nominal capacity of the radial dynamic load C_r is the radial load with constant intensity and direction that a bearing can theoretically support for a nominal duration of 1 million revolutions (ISO 281). Its value is determined for each bearing in the Fersa catalogues. In most cases, the loads applicable to the bearing are a combination of radial and axial loads which, moreover, fluctuate in magnitude and direction.

Due to this, in order to calculate the service life of a bearing, an equivalent dynamic load must be calculated using the following formula:

$$Pr = X Fr + Y Fa$$

Where Fr = radial load in Newtons, Fa = axial load in Newtons, X = radial dynamic load factor and Y = axial load factor.

The values of the X and Y factors are given in the Fersa catalogue, accompanying each reference.

When a bearing is subject to an excessive load, or to a large impulse load which surpasses the elastic limit, permanent deformations may be formed on the raceway surfaces.

The value that regulates this possibility is the nominal capacity of the radial static load Cor , and is defined as the radial static load that corresponds to the calculation of the reaction in the center of the most loaded roller contact equal to 4000 MPa (ISO 76). There also exists an equivalent static load due to the variety of possibilities of load application, with the formula:

$$Por = XoFr + YoFr$$

Where Xo = radial load factor, Yo = axial load factor and Por = equivalent static radial load in Newtons.

There are different restrictive factors to be kept in mind in more extreme situations such as: high temperatures reduction due to hardness of shafts and housings, impact, safety, etc...

Capacidades de carga

La capacidad nominal de carga dinámica radial C_r , es la carga radial constante en intensidad y dirección que un rodamiento puede teóricamente soportar para una duración nominal de 1 millón de revoluciones (ISO 281). Su valor está determinado para cada rodamiento en los catálogos de Fersa.

En la mayoría de los casos las cargas aplicadas a los rodamientos son combinaciones de cargas radiales y axiales que además fluctúan en magnitud y dirección. Debido a esto para calcular la vida del rodamiento tendremos que calcular una carga dinámica equivalente con la siguiente fórmula:

$$Pr = X Fr + Y Fa$$

Donde Fr = carga radial en newtons, Fa = carga axial en newtons, X = factor de carga dinámica axial.

Los valores de los factores X e Y se dan en el catálogo de Fersa, acompañando a cada referencia.

Cuando a un rodamiento se le somete a una carga excesiva o a una carga grande instantánea que sobrepase el límite elástico, se pueden producir deformaciones permanentes en las superficies de rodadura.

El valor que regula esta posibilidad es el de la capacidad nominal de carga elástico, se pueden producir en las superficies de rodadura unas deformaciones permanentes localmente situadas.

El valor que regula esta posibilidad es el de la capacidad nominal de carga estática radial Cor y se define como la carga estática radial que corresponde al cálculo de la reacción en el centro del contacto del elemento rodante más cargado igual a 4000 MPa (ISO 76).

También existe, debido a la variedad de posibilidades de aplicación de la carga, una carga estática equivalente con la fórmula:

$$Por = XoFr + YoFR$$

Donde Xo = factor de carga radial, Yo = factor de carga axial y Por = carga radial estática equivalente, en newtons.

Existen diferentes factores restrictivos a tener en cuenta en situaciones un poco más límites, entre ellos se podrían citar: a las temperaturas, reducción por dureza de ejes y alojamientos, de impacto, de seguridad, etc...

00.3 Sealing / Estanqueidad

Definition

Given certain applications, the mounted bearings must be protected with sealing mechanisms. These mechanisms must carry out two basic functions:

- Prevent external dirt or humidity from entering.
- Prevent lubricants from leaking out.

The service life of the bearings very often depends on the efficiency of these mechanisms.

The sealing mechanisms may vary a lot, and various factors must be considered when choosing the one to be applied:

- Type of lubricant (oil or grease).
- Rotation speed.
- Available space.
- Seal friction.
- Cost, etc.

Concerning the sealing function, if the two mechanical parts between which the leakage is likely to occur are fixed with relation to each other, the seal is called a static seal. If one or both of these parts are moving relative to the other, the seal is called a dynamic seal.

Many different methods have been or are still used for sealing, such as:

- With contact
 - Felt rings.
 - Oil lip seals.
- Contactless
 - Oil grooves.
 - Deflecting ring.
 - Labyrinth glands.

Definición

En determinadas aplicaciones, los rodamientos montados deben de ir protegidos con mecanismos de estanqueidad. Estos mecanismos tienen dos funciones básicas importantes:

- Evitar la entrada de humedad o contaminantes externos.
- Evitar la salida del lubricante.

La eficacia de estos mecanismos es importante para la vida de los rodamientos.

Los mecanismos de obturación varían bastante de uno a otro y para decidir cual aplicar se debe tener en cuenta algunos factores:

- Tipo de lubricante (aceite o grasa).
- Velocidad de giro.
- Espacio disponible.
- Rozamiento del elemento de estanqueidad.
- Coste, etc.

En lo que a la función de estanqueidad se refiere, cuando las dos partes mecánicas entre las cuales podría filtrarse el lubricante son fijas en relación la una con la otra, la obturación se llama obturación estática. Cuando una o ambas partes se mueven en relación la una a la otra, la obturación se denomina dinámica.

Se han utilizado o se siguen utilizando diversos métodos de obturación, como por ejemplo:

- Con contacto
 - Anillos de fieltro.
 - Sellados labiales.
- Sin contacto
 - Ranuras de aceite.
 - Anillos deflectores.
 - Laberintos.

Sealing Elements / Elementos de estanqueidad



Felt rings

- Simple and widely used.
- Suitable for lubrication with grease.
- Speed limit: 3-5 m/sec.
- Not suitable for high speeds or high temperatures.
- Best performance when several felt rings are used together and in combination.
- Suitable in cases without excessive dirt.

Anillos de fieltro

- Sencillos y muy utilizados.
- Adecuados en caso de lubricación con grasa.
- Límite de velocidad: 3-5 m/seg.
- Poco adecuados a altas velocidades y temperaturas.
- Mejor eficiencia cuando se utilizan varios anillos juntos y en combinación.
- Adecuados para casos sin excesiva suciedad.

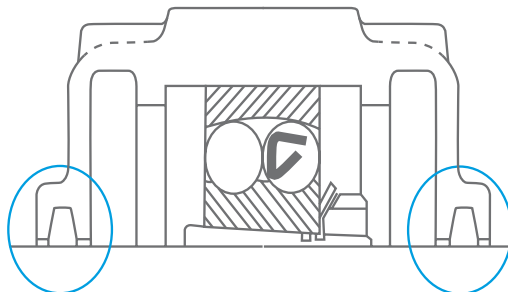

Retainers for oil and grease

- Oil lip seals.
- Standard parts. A large variety of types and sizes.
- Capacity to tolerate axle misalignment.
- The axle must have an appropriate finish and hardness.
- The sealing is a result of the lubrication film between the retainer and the axle.
- Appropriate thickness of the film must be maintained.
- Speed limit: 10-18 m/sec.
- Be careful when installing.

Retenes para aceite y grasa

- Piezas normalizadas.
- Gran variedad de tipos y tamaños.
- Capacidad para tolerar desalineamientos del eje. Éste debe tener el acabado y la dureza adecuados (sobre todo a altas velocidades).
- Estanqueidad generada por la película de lubricante entre reten y eje.
- Necesario mantener un espesor adecuado de película.
- Límite de velocidad: 10-18 m/seg.
- Requiere cuidado en su instalación.

Types

- Single lip (with or without a spring)
- Double lip (with or without a spring)

Tipos

- Un solo labio (con o sin resorte)
- Doble labio (con o sin resorte)



One lip without spring
Un labio, sin resorte



One lip with spring
Un labio, con resorte



Double lip without spring
Dos labios, sin resorte



Double lip with spring
Dos labios, con resorte

Oil Grooves

- Oil grooves in shafts, housing or both. They can have a helicoidal shape (applications with only one direction of shaft rotation) so that they can function as lubrication pumps.
- Particularly well suited in cases of low grease and low speed.
- The space between the shaft and housing should be as small as possible.
 - Ø shaft < 50 mm → 0, 25 – 0, 4 mm.
 - Ø shaft > 50 mm → 0, 5- 1 mm.
- Width: 2-5 mm / Depth: 4-5 mm.
- They are frequently used in combination with other sealing elements. Performance can be improved if filled with groove grease.

Ranuras para aceite

- Se realizan en el eje, alojamiento o en ambos. A veces tienen forma helicoidal (aplicaciones con un solo sentido de giro del eje) para actuar como bombas de lubricante.
- Particularmente efectivas en caso de lubricación con grasa y bajas velocidades.
- El espacio entre eje y caja debe ser lo más pequeño posible.
 - Ø eje < 50 mm → 0, 25 – 0, 4 mm.
 - Ø eje > 50 mm → 0, 5- 1 mm.
- Anchura: 2-5 mm / Profundidad: 4-5 mm.
- Utilizadas con frecuencia en combinación con otros elementos de obturación. Puede mejorarse su efecto llenándolas con grasa de copa.

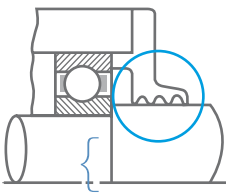

Groove in the housing
Ranura en caja

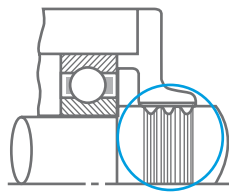

Groove in the shaft
Ranura en eje

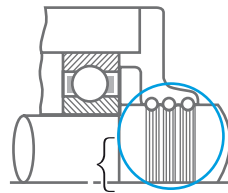

Groove in the housing and shaft
Ranura en caja y eje

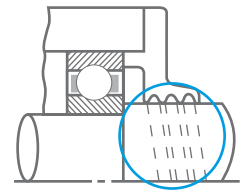

Helicoidal groove
Ranura helicoidal

Deflecting ring

- Prevents the flow of particles and entry of dirt by centrifugal force and air flow.
- Used frequently in combination with other sealing elements.
- Limits speed: 10-18 m/sec.

Types

- Installed inside the housing: the lubricant is introduced through a pump preventing a leaks.
- Installed outside the housing: prevents the entry of foreign materials into the housing.
- Type of cover: it removes the dirt by a centrifugal force.
- Forms a labyrinth with the box: the lubricant is introduced through a pump, preventing leaks.

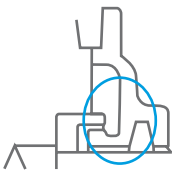

Inside the housing
Dentro de caja

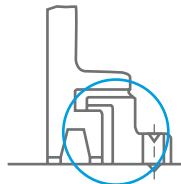

Outside the housing
Fuera de caja

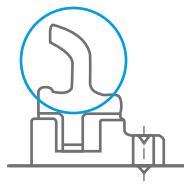

Labyrinth
Laberinto

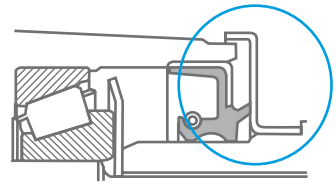

Lid
Tapa

Anillos deflectores

- Impiden el flujo de partículas y suciedad mediante fuerza centrífuga y una corriente de aire.
- Utilizados con frecuencia en combinación con otros elementos de obturación.
- Límite de velocidad: 10-18 m/seg.

Tipos

- Instalado dentro de la caja: el lubricante se introduce hacia dentro por bombeo evitando las fugas.
- Instalado fuera de la caja: se evita la invasión de material extraño dentro de la caja.
- Tipo tapa: se aparta la suciedad por fuerza centrífuga.
- Formando laberinto con la caja: el lubricante se introduce hacia dentro por bombeo evitando las fugas.

Labyrinths

- The most suitable sealing system for high speeds (no friction).
- The number of grooves varies. If the number is increased, the labyrinth is more effective (less likely to have a leak).
- Its effect can be improved by filling them with grease
- Recommended measurement (mm).

- \varnothing shaft < 50 mm
- \varnothing shaft > 50 mm

Types

- Axial: for single housing
- Radial: for complex housing

Attention: Can be oblique if you wait for a considerable misalignment between the axle and housing

Laberintos

- Lo más adecuado para altas velocidades (no hay roce).
- El nº de ranuras varía. Si aumenta el número, aumenta la eficiencia del laberinto (más dificultad para las fugas).
- Puede mejorarse su efecto llenándolos con grasa.
- Espacios recomendados (mm).

- \varnothing eje < 50 mm → Radial: 0.25–0.4 / Axial: 1–2
- \varnothing eje > 50 mm → Radial 0.5–1 / Axial: 3–5

Tipos

- Axiales: para cajas de una pieza
- Radiales: para cajas partidas

NOTA: Pueden ser oblicuos si se espera un desalineamiento considerable entre eje y caja

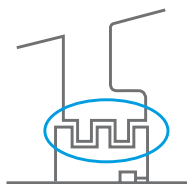

Radial Radial

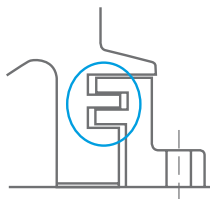

Axial
Axial

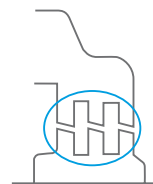

Oblique
Oblicuo

00.4 Lubrication / Lubricación

Approximately 45% of bearing failure and breakdowns are due to inadequate or insufficient lubrication, which is why lubrication is such an important aspect.

The main function of a lubricant is to allow for the correct rotation movement between the various rolling elements of the bearing, reducing friction between the contact surfaces and therefore reducing damages.

Lubrication inhibits contamination, avoids impurities, improves sealing and protects against corrosion.

The main purpose of the lubrication is to prolong the service life and optimal performance of the bearing for as long as possible.

Today there is an increasing concern for the effect that lubricants may have on the environment. Recently A&S Fersa has collaborated, together with other companies and technological centers, with the CRAFT project of "the BIOMON European Commission", towards long life bio-lubricants, using advanced design and monitoring tools, whose main objective has been the development of bio-degradable lubricants to be used in different mechanical industrial applications.

Aproximadamente el 45% de los fallos y averías que se producen en los rodamientos son debidos a una lubricación incorrecta o insuficiente, lo cual indica la importancia de esta operación.

La función que cumple la lubricación es permitir el correcto movimiento relativo entre los diversos elementos rodantes del rodamiento, disminuyendo el rozamiento entre sus superficies en contacto y, por consiguiente, reduciendo los posibles daños en ellas.

La lubricación también ayuda a impedir la entrada de contaminación e impurezas, mejora la obturación y protege contra la corrosión.

El objetivo final no es otro que lograr que el rodamiento pueda alcanzar una vida lo mayor posible y con un funcionamiento óptimo a lo largo de ella.

Hay que destacar también la importancia que está adquiriendo cada vez más la relación entre los lubricantes y el medioambiente. A&S Fersa ha colaborado recientemente con varias empresas y centros tecnológicos en el proyecto CRAFT de la Comisión Europea "BIOMON. Towards long life bio-lubricants using advanced design and monitoring tools", cuyo principal objetivo ha sido el desarrollo de lubricantes bio-degradables para poder utilizar en diversas aplicaciones mecánicas industriales.

Types of lubrication:

To lubricate is to apply a layer of lubricant between the raceways and the rolling elements. This keeps the different contact surfaces separated and prevents direct metal-to-metal contact between them.

The choice of lubricant depends on several factors:

- Viscosity of the lubricant.
- Geometric conditions of the rolling elements (the superficial texture is especially important).
- Environmental conditions (temperature, vibrations...), as well as the presence of foreign particles and contamination.
- Working conditions (rotation speeds, loads, mounting, fatigue...).

All of the above are determining factors when selecting the best lubricant and best application process (amount, cleaning, re-lubrication intervals...) for the specific bearing.

Depending on the lubrication applied, different lubrication situations can occur:



Total or hydrodynamic lubrication
Lubricación total o hidrodinámica



Partial lubrication
Lubricación parcial



Lubrication by boundary layer
Lubricación por capa límite

Total or hydrodynamic lubrication:

The surfaces of the elements implicated in the rotation are totally separated by the lubricant film in place. This is the ideal lubrication situation, since there is no wear between surfaces and the friction rate is very low.

Tipos de lubricación

La lubricación consiste en crear una película de lubricante entre las pistas de rodadura y los elementos rodantes. De esta forma, las distintas superficies que se encuentran en contacto quedan separadas y se evita el contacto metálico entre ellas.

Esta película de lubricante depende de diversos factores:

- Viscosidad del lubricante.
- Condiciones geométricas del rodamiento (especialmente importante es la rugosidad superficial).
- Condiciones ambientales (temperatura, vibraciones...) así como la posible presencia de partículas extrañas y contaminación.
- Condiciones de funcionamiento (velocidad de giro, cargas aplicadas, montaje, fatiga...).

Todas estas condiciones influyen notablemente a la hora de seleccionar el lubricante y el propio proceso de lubricación (cantidad de lubricante, limpieza, frecuencia de relubricación...).

Existen distintas situaciones de lubricación en función de la película de lubricante creada:

Lubricación total o hidrodinámica:

Las superficies de los elementos involucrados en el movimiento relativo se encuentran totalmente separadas por la película de lubricante. Es la situación ideal de lubricación ya que no hay desgaste entre las superficies y el coeficiente de rozamiento es muy bajo.



Lubrication by grease / Lubricación por grasa

Partial lubrication:

This is real lubrication scenario, since there are some areas in contact despite the existing layer of lubricant.

Lubrication by boundary layer:

When the amount of lubricant is insufficient or the relative movement too slow, the layer is thinner and cannot prevent metal-to-metal contact; which causes more friction and generates more heat, which in turn increases the temperature and further reduces the layer of lubricant protection available. To prevent this, additives are used in the lubricant. These additives react with the metal parts and generate a boundary layer that reinforces the lubricant protection.

Solid Lubrication:

For less severe working conditions, there are different types of solid lubricants (graphite, lithium grease...) to help improve lubrication that prevents direct metal-to-metal contact between surfaces.

Lubricación parcial:

Corresponde a la situación que se da en la realidad, ya que existen algunas zonas de contacto metálico a pesar de la película de lubricante. Lo que interesa es conseguir el mayor espesor posible de la película de lubricante.

Lubricación por capa límite:

Cuando la cantidad de lubricante es insuficiente o el movimiento relativo demasiado lento, la capa de lubricante tiene menor espesor y no puede evitar el contacto metálico. Por ello, el coeficiente de fricción y la generación de calor aumentan, incrementando la temperatura y reduciéndose aun más la película de lubricante. Para evitar esta situación se utilizan aditivos en el lubricante. Estos aditivos reaccionan con las partes metálicas y generan una capa límite que refuerza la lubricación.

Lubricación sólida:

En condiciones menos severas de funcionamiento, existen diversos tipos de lubricantes sólidos (grafito, bisulfuro de molibdeno...) que pueden ayudar a mejorar la lubricación ya que evitan el contacto metálico entre superficies.

Types of lubricants

There are two main lubrication options to choose from, grease or oil:

Grease

It's the most widely used type of lubricant:

- Simpler design and more economical lubrication system.
- Less maintenance needed (there is a life lubrication option available).
- Good tightness and low contamination risk (cleaning).

Grease lubrication provides a high safety level at low speeds.

They are oil based (mineral, silicon, ester) mixed with lithium, sodium or calcium soap thickener for density (sometimes salt from the metal soap is added to form a thickening complex). Polyurea, Teflon or bentonite can be used instead of soap.

When selecting grease, the consistency, temperature range and corrosion resistance, miscibility, mechanical stability, rate of fluidity, etc., determine its suitability to perform under different conditions and work requirements (load carrying ability, speed, temperature, vibrations, etc.). The following table shows detailed information of the capacities of the different greases:

Type of grease Tipo de grasa	Lithium / Litio		Sodium / Sodio		Calcium / Calcio		Bentonite Bentonita	Polyurea Poliurea	Teflon Teflón
	N	C	N	C	N	C			
Temperature Temperatura (°C)	-30 / 130	-30 / 160	-30 / 100	-30 / 120	-30 / 60	-30 / 130	-30 / 160	-40 / 210	-35 / 250
Pressure Presión	1	2	1	2	1	2	1	1	2
Water resistant Resistencia al agua	3	2	1	1	3	2	3	3	3
Corrosion Corrosión	2	1	2	3	2	2	1	1	1

N= Normal / Normal

C= Complex / Complejo

1- Regular resistance / Resistencia regular

2- Good resistance / Buena resistencia

3- Very good resistance / Muy buena resistencia

Tipos de lubricantes

A la hora de lubricar un rodamiento se puede optar principalmente entre utilizar aceite o grasa:

Grasa

Utilizadas en el 90% de las aplicaciones de rodamientos.

- Diseño más sencillo y económico del sistema de lubricación.
- Menor necesidad de mantenimiento (existe la opción de lubricación de por vida).
- Buena estanqueidad y bajo riesgo de contaminación (limpieza).

Alta seguridad a bajas velocidades.

Consisten en una base de aceite (mineral, de silicona, éster) con un espesante de jabón de litio, sodio o calcio que le da cuerpo (a veces se añade una sal del mismo metal del jabón para formar un espesante complejo). También puede utilizarse poliurea, teflón o bentonita en lugar de jabón.

Sus propiedades de consistencia, resistencia a temperatura y corrosión, miscibilidad, estabilidad mecánica, punto de fluidez, etc. determinan su conveniencia para trabajar en diversas condiciones y exigencias de trabajo (cargas, velocidades, temperaturas, vibraciones, etc.). En la siguiente tabla se muestra un resumen de las capacidades de las diferentes grasas:



Example of oil
Ejemplo de aceite



Example of grease
Ejemplo de grasa

Grease. Lubrication processes

Under not very severe working conditions, there is a life lubrication option that also uses seals to help keep the lubricant inside in the bearings (especially where high vibrations and temperatures are concerned). However, under more severe conditions re-lubrication is necessary. Also the bearing must be greased once it is mounted, before being operative (reduces contamination risk) and should have been cleaned before greasing if not new. The amount of grease should not be excessive (possible engine size-up), nor should it be insufficient (damage to bearing).

The amount of grease should range approximately between 20 to 35% of the empty space in the bearing. The bearing is rotated completely so that it is totally immersed in grease.

Grasa. Proceso de lubricación

En casos de condiciones de funcionamiento poco severas puede realizarse una lubricación de por vida, incluso utilizando retenes para ayudar a que la grasa permanezca en el rodamiento (especialmente con altas vibraciones y temperaturas). Sin embargo, en condiciones severas debe realizarse una relubricación. Asimismo, el rodamiento debe engrasarse una vez se encuentre montado antes de funcionar (se reduce el riesgo de contaminación) y debe haberse limpiado previamente al engrase si no es nuevo.

La cantidad de grasa no debe ser excesiva (posible gripado) ni insuficiente (deterioro del rodamiento). La grasa debe ocupar del 20 al 35% del espacio libre del rodamiento aproximadamente. El rodamiento se hace girar antes de montarlo para que la grasa lo impregne todo.

$$g = 0,0121(D-d) \times B$$

Equation / Ecuación

Oil

Oil lubrication is used in 10% of bearings applications.

- Good performance at high speeds and heavy loads.
- Better ability for heat dissipation.
- More precise and efficient cleaning of particles.
- Possibility of recycling oil to lubricate other bearing elements (cost reduction).
- Easy monitoring of lubricant (condition and level).

The following oils are used in bearing applications:

- Minerals (most often used).
- Synthetics (used for specific applications): polyolefin, polyglycol, ester, oil fluorides, silicon oils...

When selecting an oil with the correct viscosity; temperature range, speed and load to be carried must be taken into account. The following table shows detailed information of the different oils and their specifications:

An oil lubricant should be chosen according to the required viscosity in order to guarantee an adequate lubrication in relation to the working temperature.

Aceite

Empleados en el 10% de las aplicaciones de rodamientos.

- Buen comportamiento a elevadas velocidades y altas cargas.
- Mayor capacidad para disipar calor.
- Limpieza de partículas más precisa y eficaz.
- Existe la posibilidad de aprovechar el mismo aceite para lubricar otras piezas cercanas al rodamiento (reducción de costes).
- Fácil control del lubricante (estado y nivel).

Para las aplicaciones de rodamientos se utilizan los siguientes tipos de aceites:

- Minerales (los más utilizados).
- Sintéticos (utilizados para casos especiales de aplicaciones): polialfaolefinas, poliglicoles, ésteres, aceites fluorados, aceites de silicona...

Se debe elegir un aceite de viscosidad adecuada teniendo en cuenta las condiciones de temperatura, velocidad y cargas. En la siguiente tabla se muestra un resumen de los aceites y sus capacidades.

Un aceite lubricante se selecciona sobre la base de viscosidad requerida para asegurar una adecuada lubricación a la temperatura de funcionamiento.

Type of oil Tipo de aceite	Mineral oils Aceites minerales	Synthetic oils / Aceites sintéticos				
		Polyglycols Poliglicole	Polyalphaolefines Polialfaolefina	Esters Ésteres	Silicone oils De silicona	Fluorated Fluorados
Viscosity Viscosidad 40°C (mm ² /sg)	2 / 4500	20 / 2000	15 / 1500	7 / 4000	4 / 100000	20 / 650
Temperature Temperatura (°C)	-50 / 170	-50 / 200	-20 / 160	-60 / 120	-70 / 200	-60 / 250
Loads Cargas	3	3	3	2	1	2
High speed Alta velocidad	2	2	2	3	2	2
Rusting Oxidación	1	3	2	3	2	3

1- Regular resistance / Resistencia regular

2- Good resistance / Buena resistencia

3- Very good resistance / Muy buena resistencia

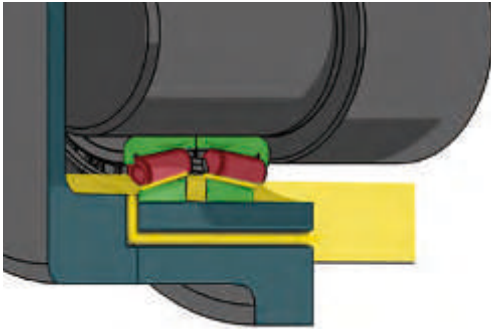

Oil bath
Baño de aceite

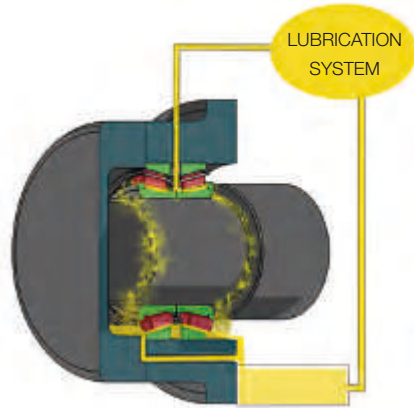

Oil circulation
Circulación de aceite

The time lapse from functioning to fatigue and protection from wear is best when the contact surfaces are well separated by the lubricant. Because the thickness of the lubricant layer increases with the oil viscosity, in theory oil with high viscosity should be chosen for the application. However, as the viscosity increases so does the friction of the lubricant, so the oil lubricant chosen should have enough viscosity to sustain the fatigue, while at the same time providing enough oil lubrication for the bearings.

There is a certain K relation between the viscosity (ν) of the selected oil to the temperature when the bearing is functioning, and the necessary cinematic speed ν_1 for a satisfactory lubrication.

Oils. Lubrication Processes

If an excessive amount of oil is used, the refrigeration level is good, but friction increases. For this situation there are different lubrication systems:

- *Oil bath or immersion:* A simple method for low speeds. When not moving, the bath should cover half of the lower part of the rolling element, so that when it rotates the oil is distributed on all of the parts. The oil level should be checked periodically and replaced according to contamination and wear (more when temperatures are high and if oxygen and abrasives are present). This should be done every two months.

El tiempo de funcionamiento a fatiga y la seguridad contra el desgaste son mejores cuanto más estén separadas las superficies de contacto por una película lubricante. Como el espesor de la capa lubricante aumenta con la viscosidad del aceite, en teoría se debería elegir un aceite de elevada viscosidad de servicio; pero al aumentar la viscosidad, aumenta el rozamiento del lubricante.

Por esta razón el aceite debe elegirse con una viscosidad tal que se consiga una elevada duración a la fatiga, asegurando al mismo tiempo una lubricación suficiente de los rodamientos con aceite.

Existe una cierta relación K entre la viscosidad ν del aceite seleccionado a la temperatura de funcionamiento, y la velocidad cinemática ν_1 , necesaria para una lubricación satisfactoria.

Aceites. Proceso de lubricación

Si se utiliza gran cantidad de aceite, la refrigeración es buena pero aumenta el rozamiento. En este caso tenemos distintos sistemas de lubricación:

- *Baño de aceite o inmersión:* método simple para bajas velocidades. En reposo, el baño debe cubrir hasta la mitad del elemento rodante inferior de forma que, al girar, el aceite es distribuido a todas las partes. El nivel de aceite debe comprobarse regularmente y su recambio depende de la suciedad y el envejecimiento (mayor contra más alta es la temperatura y también con presencia de oxígeno y abrasivos). Esta comprobación debe realizarse cada 2 meses.

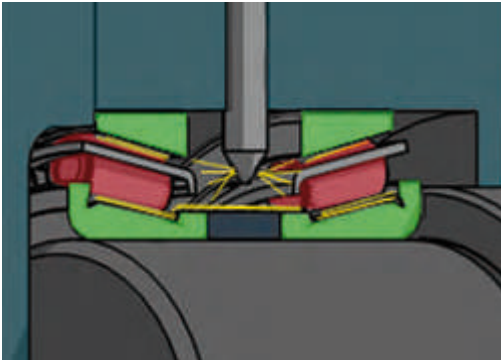

Injection of oil
Inyección de aceite

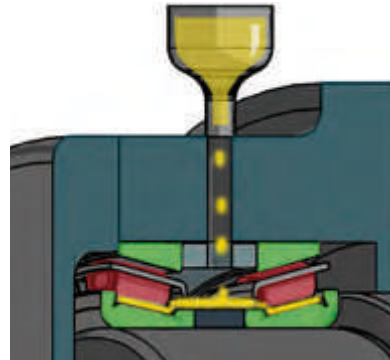

Lubrication by dripping
Lubricación por goteo

- *Oil circulation:* The oil is brought to the bearing from a deposit by a system of pumps, tubes and valves. The bearing should be lubricated before being operative and the amount of oil depends on the working conditions and the size of the bearing (more or less, between 0, 5 and 50 l/m). This procedure in combination with the oil bath greatly improves bearings features.
- *Oil circulation:* el aceite se lleva desde un depósito hasta el rodamiento mediante un sistema de bombas, tuberías y válvulas. El rodamiento debe estar lubricado antes de empezar a funcionar y la cantidad de aceite depende de las condiciones de funcionamiento y el tamaño del rodamiento (entre 0,5 y 50 l/m aproximadamente). Si se utiliza este sistema combinado con un baño de aceite se mejoran mucho las prestaciones.
- *Injection of oil:* at high speed (at least 15 m/s). It is advisable to inject the oil in the direction of the bearing.
- *Inyección de aceite:* a altas velocidades (al menos a 15 m/s de velocidad). Es conveniente inyectarlo de forma dirigida hacia el rodamiento.
- *Lubrication by dripping:* the oil must be applied by a drip system, it must be sufficiently fluid to flow through the application equipment. During operation the lubricant must be viscous and tacky enough to resist squeeze-out.
- *Lubricación por goteo.* El aceite debe ser aplicado por un sistema de goteo, debe ser suficientemente líquido para fluir a través del equipo de aplicación. Durante el funcionamiento el lubricante debe ser viscoso y pegajoso.

With small quantities of oil (10 mg / h), using a lubrication system through a drip, as an oil mist or transported through the air, results in a more precise lubrication, forming a film between the contact surfaces which decreases the friction and maintains a low temperature.

Con pequeñas cantidades de aceite (10mg/h), utilizando sistemas de lubricación por goteo, neblina de aceite o transporte por aire, se consigue una lubricación más precisa ya que se crea una película entre las superficies en contacto que disminuye el rozamiento y mantiene una temperatura baja.

00.5 Handling and assembly / Manejo y operaciones de montaje

Bearings are high precision components, given that they require tolerance for the order of a few microns. Furthermore, during the fabrication process a number of quality controls are carried out in order to ensure perfect application for the requirements of each client in terms of durability, reliability and turning precision.

According to statistics more than 98% of bearing failures are due to external factors: lubrication, assembly, inadequate bearing selection, dirt.

Around 10% of premature bearing failures are due to bad storage or handling.

Therefore, to guarantee optimum bearing function special attention must be taken in the storage handling and assembly stages.

Storage

Fersa bearings are made from manufacturing with a superficial high quality lubricant protection compatible with any other future lubricant that might be used, appropriately packaged with thermo-seal plastic, individual box or industrial packaging.

Previous to use they should be kept in their original package and stored in a clean and dry environment, protected from the effect of excessive vibrations.

Packaging may only be removed when and where the assembly of the bearing takes place.

Los rodamientos son componentes de alta precisión, dado que sus dimensiones requieren tolerancias del orden de unas pocas micras. Además, durante todo el proceso de fabricación, se realizan numerosos controles de calidad destinados a asegurar el absoluto respeto de los requerimientos de cada cliente en términos de durabilidad, fiabilidad y precisión de giro.

Estadísticamente, más del 98% de los fallos son debidos a causas externas al propio rodamiento: lubricación, montaje, mala elección del rodamiento, suciedad...

Alrededor de un 10% de esos fallos prematuros de los rodamientos son como consecuencia de un mal almacenamiento o una mala manipulación.

Por tanto, para garantizar la óptima función del rodamiento, es necesario prestar la debida atención a las etapas de almacenaje, manejo y montaje.

Almacenamiento

Los rodamientos salen de Fersa Bearings con una protección superficial de alta calidad y compatible con cualquier lubricante que se vaya a utilizar en la aplicación. Además salen adecuadamente embalados con plástico termosellado, caja individual o embalaje industrial.

Previo a su uso, los rodamientos deben ser mantenidos en su embalaje original y almacenados en un lugar limpio y seco, donde no les afecten muchas vibraciones.

Por último, el embalaje protector debería ser retirado solo en el momento y lugar de montaje.

Handling and Assembly

Prior to the assembly:

- Hands must be clean and dry. Use of gloves is preferable.
- Keep assembly area clean (at a distance from chip conveyor machines).
- Handle bearings with care (avoiding blows or falls).
- Never wash or clean a bearing before mounting on an application.
- Cover bearings when not in use.
- Use appropriate tools, with no symptoms of wear and tear.
- Ideally specific tools will be used according to the size of bearing.
- Avoid impacts. *Do not use a HAMMER directly on a bearing! A bearing that has been thermo-stabilized at a certain hardness level is vulnerable to impacts or to the use of excessive force during insensitive assembly or dismounting actions.*

During the assembly:

- Keep the shaft and housing clean, as well as the work space area.
- Take precaution when handling rectified bearing surfaces so as to avoid the appearance of any trace of rust.
- Use the corresponding lubricant according to the application thereof.
- Apply the appropriate quantity of lubricant.
- Verify that the bearing sits correctly between housing and shaft.
- In the case of a tapered bearing → when mounting the internal and exterior rings separately, be careful to apply force to each ring individually; and take care, for example, when mounting, that the outer ring doesn't touch the already mounted inner ring.

Manejo y Montaje

Antes del montaje:

- Las manos deben de estar limpias y secas. Si es posible usar guantes.
- Mantener el área de trabajo limpia (sin máquinas de arranque de viruta cerca).
- Manejar los rodamientos con cuidado (sin caídas, sin golpes).
- No lavar/limpiar nunca un rodamiento nuevo, antes de montarlo en una aplicación.
- Cubrir los rodamientos cuando no estén en uso.
- Usar herramientas adecuadas si es posible, sin síntomas de desgaste.
- Idealmente utilizaremos utillajes específicos, para cada tamaño de rodamiento.
- Evitar impactos. *¡No usar el MARTILLO directamente sobre el rodamiento! El rodamiento que está tratado térmicamente para alcanzar unos determinados niveles de dureza, se puede considerar frágil ante impactos o fuerzas excesivas realizadas durante montajes o desmontajes poco cuidadosos.*

Durante el montaje:

- Mantener limpio el eje y el alojamiento así como el lugar de trabajo.
- Precaución al manipular las superficies rectificadas del rodamiento para impedir la aparición de rastros de óxido.
- Usar un lubricante adecuado para la aplicación.
- Aplicar una cantidad adecuada de lubricante.
- Asegurar que el rodamiento esté correctamente asentado en eje y alojamiento.
- En el caso de los cónicos → Al montar los anillos interior y exterior por separado, aplicar fuerza también a cada uno por separado evitando montar, por ejemplo, el aro exterior golpeando el aro interior montado.

Use

According to the required application and the more relevant specifications thereof, a comparative chart may be established of the various bearing categories.

Failure diagnosis

Under normal operating conditions, the bearing is not damaged because of wear but because of fatigue. Nevertheless, most breakdowns are due to causes that could have been avoided.

For that reason, the possibility of reaching conclusions about the cause of a defect by means of studying its appearance is very useful.

Besides, it is easier and cheaper to prevent damages than to determine and correct the cause of breakdown after the machine or equipment has already started to operate.

Statistically, more than 90 % of failures are due to external factors: lubrication, assembly, inadequate bearing selection, dirt... and it is, precisely, the assembling process that is responsible of nearly 40 % of failures.

The bearings are high precision components and they must be handled as such. The previous methods and the ones used during the process of assembly determine to a great extent bearing precision and life.

Uso

En función de la aplicación requerida y de las características más relevantes de la misma, se puede establecer una tabla comparativa entre las diversas categorías de rodamientos.

Diagnóstico de defectos

En condiciones normales de uso, el rodamiento no se destruye por desgaste sino por fatiga. Sin embargo, la mayoría de las averías en los rodamientos son debidas a causas que podrían haberse evitado.

Es por ello de gran utilidad, obtener conclusiones sobre la causa que ha originado un defecto, mediante el análisis del aspecto del mismo.

Además es mucho más fácil, y mucho menos costoso, prevenir daños que determinar y corregir la causa de avería después de que la máquina o equipo entró en servicio.

Según las estadísticas, más del 90 % de los fallos son provocados por factores externos como la lubricación, el montaje, la elección errónea del rodamiento, suciedad... y es, precisamente, el proceso de montaje el responsable de aproximadamente el 40 % de los fallos.

Los rodamientos son componentes de alta precisión y deben ser manipulados como tales. Los métodos previos y aquellos usados durante el proceso de montaje de los rodamientos afectan en gran medida a su precisión y vida útil.

00.6 Failure diagnosis / Diagnóstico de defectología

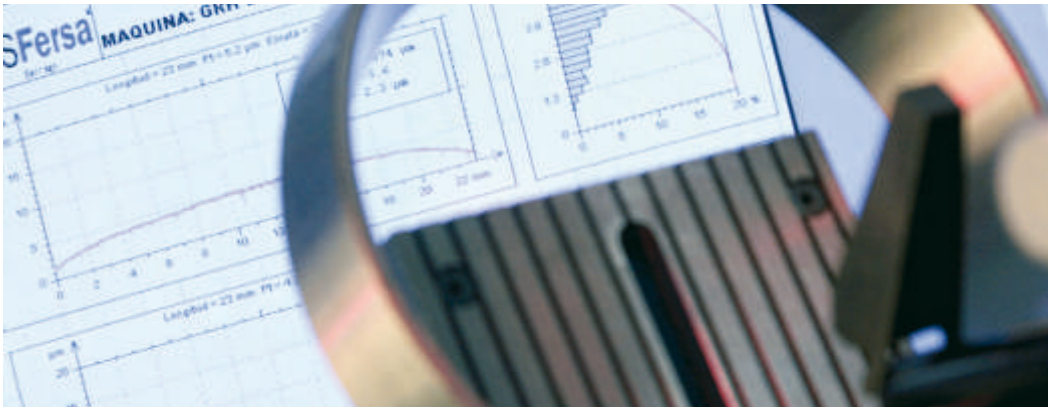

External causes for bearing breakdown / Causas externas para el fallo del rodamiento

Quality of assembly

- Insufficient or incorrectly adapted methods and means.
- Pollution in the assembly.
- Careless setting.
- Badly manufactured external components: tolerances, misalignment, poor application of lubricant...

Operating

- Accidental or not accidental overloads.
- Presence of vibrations during the stop.
- Excessive speeds.
- Axle bearing.

Calidad del montaje

- Método y medios insuficientes o mal adaptados.
- Suciedad en el montaje.
- Colocación poco cuidadosa.
- Mala fabricación del entorno del rodamiento: tolerancias, desalineación, mal acceso de la lubricación...

Condiciones del funcionamiento

- Sobrecargas accidentales o voluntarias.
- Aparición de vibraciones durante la parada.
- Velocidades excesivas.
- Flexión de los ejes.

Environmental

- Room temperature too low or too high.
- Pollution by water, dust, chemical products.
- Presence of electrical current.

Lubrication

- Choice of lubricant.
- Quantity (too high or too low).
- Frequency of inspection.

Condiciones de entorno

- Temperatura de ambiente demasiado baja o elevada.
- Contaminación por agua, polvo, productos químicos.
- Paso de corriente eléctrica.

Lubricación

- Elección del lubricante.
- Cantidad (demasiada o poca).
- Frecuencia en la inspección.

Flaking / Exfoliación



Description

A Phenomena that appears because of fatigue, it occurs on the surface of the raceway or rolling elements, after working under repeated contact forces for a period of time. Its result is metal particles loosening in a layer on the surface. This failure is often found at an early stage, and will extend in a short time. It's always accompanied by noise increase.

Causes

Poor assembly (misalignment), inappropriate or insufficient lubrication, inaccurate shape of shafting or housing, improper bearing clearance and excessive loads.

Solutions

Choose a bearing with a heavier rate load, improve lubrication or the sealing mechanism, check the load conditions, improve the mounting method, increase the lubricant viscosity and check the internal clearance.

Descripción

Fenómeno que se presenta por fatiga y ocurre en uno de los caminos de rodadura o en los elementos rodantes, después de un periodo de operación bajo esfuerzos repetidos de contacto.

Es un desprendimiento del metal en cascarillas en una capa de la superficie. Este fallo aparece a menudo de manera temprana, y se extiende rápidamente. Viene acompañado por un incremento de ruido.

Causas

Montaje desalineado, lubricación inadecuada o insuficiente, tolerancias, aprietes excesivos y sobrecargas, geometría del eje o alojamiento poco precisa.

Soluciones

Elegir un rodamiento con mayor capacidad de carga, mejorar la lubricación e incrementar la viscosidad del lubricante o el aislamiento del mismo, verificar las condiciones de carga, mejorar el proceso de montaje y comprobar la holgura interna.

Pitting / Gripado

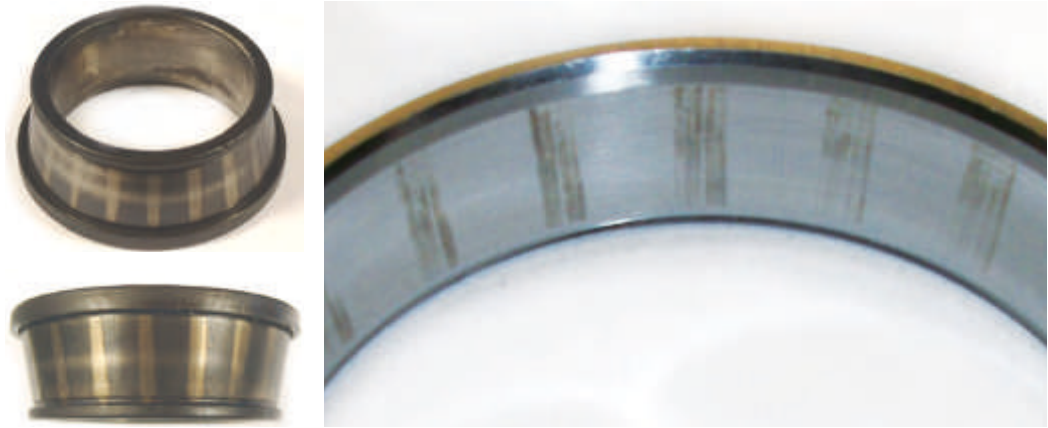

Description

A phenomena where matt zones or dark stains appear, indicating a superficial removal of material. Shallow depressions can also happen on the bearing raceways in locations corresponding to the pitch of rolling elements. The grinding has completely disappeared in those areas.

Causes

Incorrect handling during mounting, absence of lubrication, adjustment of tolerances, excessive preloading and high speeds with low loads.

Solutions

Improve the lubricant film increasing its viscosity, enhance the sealing mechanism and check the initial loads.

Descripción

Arranques superficiales de material acompañados de zonas mates o manchas oscuras. En la zona de contacto entre los elementos rodantes pueden aparecer también marcas y pequeñas deformaciones. La rectificación ha desaparecido por completo en esas zonas.

Causas

Manipulación incorrecta en el montaje, ausencia de lubricación, tolerancias de ajuste, excesiva precarga y velocidades elevadas con poca carga.

Soluciones

Mejorar la capa de lubricante incrementando su viscosidad, comprobar las cargas iniciales y mejorar el mecanismo de protección.

Marks on rolling bodies due to deformation or material extraction / Huellas de cuerpos rodantes por deformación o arranque de material



Description

In the assembly of bearings whose outer and inner rings are assembled separately, this is one of the most frequent causes of damage when the bearing is mounted. It appears after a shock or excessive pressure on the rollers or raceway surfaces. Usually the rings might not be tight enough.

Causes

Unsuitable handling during assembly or disassembly and accidental fall of the bearing.

Solutions

Improve mounting and dismounting processes, use lubrication before mounting and review the loading conditions.

Descripción

Esta es la avería más común en el montaje de rodamientos cuyos aros interior y exterior son desmontables. Aparece tras un golpe o esfuerzo sobre los perfiles de rodadura. En ocasiones los componentes no están endurecidos lo suficiente.

Causas

Inadecuado manejo durante el ensamblado, montaje forzado y caída accidental del rodamiento.

Soluciones

Mejorar el ensamblado o desensamblado el rodamiento, usar lubricación antes del montaje y verificar la condición de carga.

Wear, signs of foreign material / Desgaste, huellas de cuerpos extraños**Description**

Wear is caused due to more or less intense friction at the surface of rolling elements, raceway, rib, face, cage...

A surface deterioration can also take place due to contamination of foreign matters.

Causes

Improper lubrication, entry of foreign matter and lack of protection during the setting of the bearing or during its operation.

Solutions

Keep the bearing and its surrounding clean, improve the lubrication mechanism, improve the sealing, filter the lubrication oil and prevent misalignment.

Descripción

Huellas de rodadura de mayor o menor intensidad en los cuerpos rodantes y en las pistas.

Se puede generar un juego excesivo, ruido anormal y desgaste de las jaulas.

Causas

Inadecuada lubricación, falta de protección durante el montaje y entrada de partículas extrañas.

Soluciones

Mantener limpio el rodamiento y su entorno, mayor lubricación y prevenir el desalineamiento.

Craters and grooves / Cráteres y estrías



Description

Also described as electrical corrosion, the points of contact in the bearing are melted locally to form craters and grooves.

Craters appear like cuts of flat edges joined in series, showing that there has been a localized fusion of the metal. Grooves are a succession of narrow cracks, next to each other, in the zone of the races where the load is applied.

Causes

Potential electrical difference between rings and currents of low or high intensity passing through the bearing.

Solutions

Insulate the bearing and prevent a current flow from passing through the bearings.

Descripción

Fenómeno también descrito como corrosión eléctrica, que provoca que los puntos de contacto del rodamiento se fundan localmente formando cráteres y estrías.

Los cráteres aparecen como picaduras unidas en serie, evidenciando que ha habido fusión de metal.

Las estrías son una sucesión de hendiduras estrechas, en la zona de las pistas sometidas a carga.

Causas

Diferencial de potencial eléctrico entre los anillos y corrientes de débil o fuerte intensidad a través del rodamiento.

Soluciones

Aislar el rodamiento, prevenir el flujo de corriente eléctrica a través del rodamiento.

Hitmarks, fissures and breakages / Marcas de golpes, fisuras y roturas**Description**

A fracture is the result of crack propagation to the point of complete separation of a portion of the component. Hitmarks and traces of tools appear in the flat faces, the rolling elements and the chamfers.

Causes

The ultimate tensile strength of the material is exceeded, heat generation, extreme stress concentration, local impact and excessive interference fit.

Solutions

Improve the handling method, review and decrease the interference, avoid impacts, and reduce heavy loads.

Descripción

Marcas de golpes y de las huellas de herramientas en las caras planas, los elementos rodantes y los chaflanes.

Aparición de fisuras y roturas en los rodamientos.

Causas

Concentración de tensiones, generación de calor y golpes sobre los anillos, carga puntual excesiva.

Soluciones

Mayor cuidado en la manipulación de los rodamientos, evitar impactos y reducir las grandes cargas.

Contact corrosion / Corrosión de contacto



Description

A chemical reaction motivated by relative micromovements between contact surfaces. These micromovements lead to oxidation, becoming visible as pink, dark or black stains of different intensity. When rubbed, these stains leave signs of rust. Loss of material from one or both mating surfaces is also usual.

Causes

Vibration with a small amplitude, insufficient tightening and improper lubrication.

Solutions

Check the bearing clearance, improve the lubricant mechanism and control the source of vibration.

Descripción

Reacción química provocada por micromovimientos entre las superficies, las cuales pueden generar oxidación. Aparecen manchas rosas, oscuras o negras más o menos extensas en el diámetro interior, en el diámetro exterior o en las caras de apoyo del rodamiento. Al frotarlas, estas manchas dejan señales de óxido.

Causas

Vibraciones de pequeña amplitud, apriete insuficiente y lubricación inadecuada.

Soluciones

Verificar la tolerancia de ajuste del rodamiento, mejorar la lubricación y controlar la vibración.

Corrosion - Rusting / Corrosión - Oxidación



Description

When the bearing material is in contact with acid or water, oxidation on the rings or over the entire bearing surfaces takes place. Corrosion leads to stains of different sizes in reddish or black color, which affect the surface or cavity.

Causes

Accidental or systematic entry of humidity or corrosive liquids inside the bearings, unsuitable conditions (T_a and humidity) during storage and defects in the sealing of assembly.

Solutions

Prevent rust formation by adequate treatment, improving the sealing, checking the lubricant periodically and verifying the handling method.

Descripción

Oxidación localizada o generalizada del rodamiento producida cuando está en contacto con ácido o agua. Se genera decoloración marrón o rojiza, con ataques en la superficie de rodadura o exterior.

Causas

Introducción accidental o sistemática de humedad o líquidos corrosivos, defecto de estanqueidad del montaje, almacenamiento inadecuado.

Soluciones

Tratamiento adecuado para prevenir la aparición de óxido, mejorar la estanqueidad y emplear lubricantes con aditivos anticorrosión.

Damage to the cage / Daños en la jaula



Description

Under this description, several damages are included, such as cage distortion, fracture and wear. Since cages are made from soft material, they tend to be distorted by external forces or from contact with other components.

Causes

Assembly without caution, shocks and hits, excessive rotation speed, poor lubrication and abnormal temperature.

Solutions

Check the mounting process, check the boundary conditions (T_a , speed, load), use the correct cage type and select the right lubricant.

Descripción

Bajo esta denominación se incluyen diversos efectos, como la deformación de la jaula, marcas de golpes, fracturas y desgastes.

Dado que las jaulas son de un material más blando y menos resistente, tienden a deformarse más fácilmente por la acción de fuerzas externas o por el simple contacto con el resto de componentes del rodamiento.

Causas

Montaje sin precauciones, golpes, excesiva velocidad de rotación, lubricación insuficiente y temperatura de servicio anormal.

Soluciones

Controlar el proceso de montaje, comprobar las condiciones de funcionamiento (temperatura, velocidad y carga), elegir la jaula más apropiada y lubricación correcta.

Sign of foreign parts due to abrasion / Huellas de cuerpos rodantes por abrasión**Description**

Rings show marks in their races, either shiny or not, more or less extensive, whose separation corresponds to the one of the rolling elements. These marks are the result of the matter absence (no re-casting). The signs of grinding have disappeared.

Causes

Inclination of rings during mounting, inappropriate lubricant and shock load assembly or disassembly operations.

Solutions

Use appropriate jig and tool, check the interference, correct the sleeve tightening and improve lubrication.

Descripción

Fenómeno similar a la corrosión por contacto, también conocido como falso brinelling. Los aros presentan en las pistas huellas, brillantes o no, más o menos extensas, cuya separación corresponde a la de los elementos rodantes. Las huellas son producto de la desaparición de material (no fusión). Las señales de rectificación han desaparecido.

Causas

Inclinación de los anillos durante el montaje, lubricante inadecuado y vibraciones.

Soluciones

Utilizar las herramientas más apropiadas, corregir las interferencias, evitar vibraciones y mejorar la lubricación.

Coloration / Coloración



Description

A phenomena in which a brown coloration takes place in the rings and the rolling elements due to the superficial rusting and polymerization of the lubricant at high temperature.

Causes

Excessive overheating of external or internal origin, inappropriate lubricant, deterioration of the lubricant or adhesion of powders generated by friction during operation.

Solutions

Enhance the heat dissipation and improve the lubrication method.

Descripción

Fenómeno en el que aparece una coloración marrón en los aros y en los elementos rodantes debida a una oxidación superficial y a la polimerización a altas temperaturas del lubricante.

Causas

Calentamiento excesivo de origen interno o externo, lubricación inadecuada o insuficiente, deterioro del lubricante o adhesión de partículas durante el funcionamiento.

Soluciones

Asegurar una buena disipación del calor y mejorar la lubricación.

Summary chart / Cuadro resumen

Observation of damage /
Deterioros observados

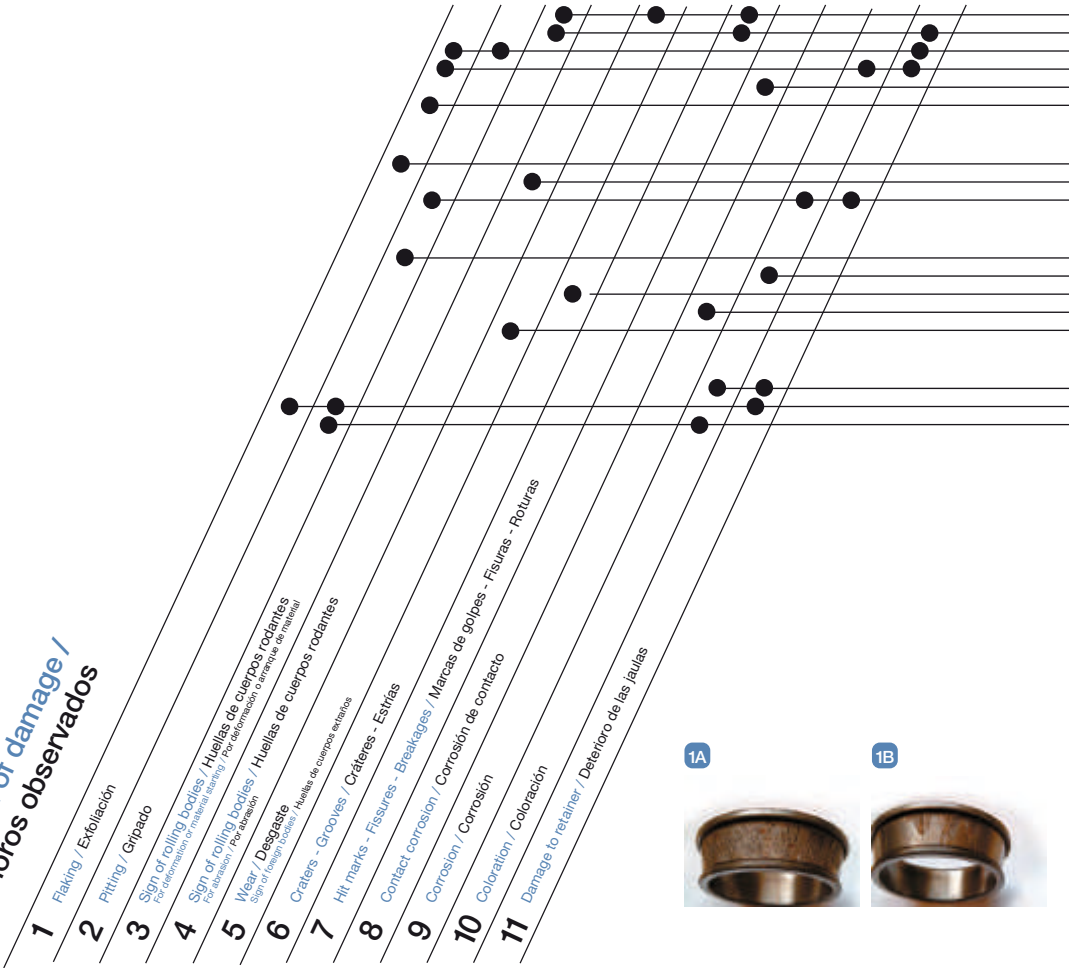

Cause of wear or defect / Origen del deterioro o defecto

Anomalies observable during operation / Anomalías observadas en funcionamiento

ASSEMBLY / MONTAJE

Lack of care / Falta de cuidado
Hits / Golpes
Defect in housing or support / Defectos en los alojamientos o apoyos
Too tight adjustment / Ajuste demasiado prieto
Too loose adjustment / Ajuste demasiado flojo
No alignment / Desalinamiento

OPERATION / FUNCIONAMIENTO

Overload / Sobrecarga
Vibrations / Vibraciones
Excessive speed / Velocidad excesiva

ENVIRONMENT / ENTORNO

Too low temperature / Temperatura demasiado baja
Too high temperature / Temperatura demasiado elevada
Passing of electric current / Paso de corriente eléctrica
Water pollution / Polución por agua
Dust pollution / Polución por polvo

EXCESS OF LUBRICANT / EXCESO DE LUBRICANTE

Inadequate lubrication / Lubricación inadecuada
Absence of lubricant / Falta de lubricante
Excess of lubricant / Exceso de lubricante

NOISE / RUIDOS

VIBRATION / VIBRACIONES

COUPLE: TEMPERATURE
ELEVATION /
PAR: ELEVACIÓN
DE TEMPERATURA

1C



3



4



10















11



00.7 Table of applications / Tabla de aplicaciones

Bearing type Tipo de Rodamiento		Deep groove ball bearing Rodamiento de bolas de ranura profunda	Angular contact ball bearing Rodamiento de bolas de contacto angular	Double row angular contact ball bearing Rodamiento de doble hilera de bolas de contacto angular	Paired angular contact ball bearings Rodamiento de bolas dúplex de contacto angular	Four point contact ball bearing Rodamiento de bolas de cuatro puntos de contacto	Self-aligning ball bearing Rodamiento de bolas autoalineantes	Cylindrical roller bearing Rodamiento de rodillos cilíndricos	Double row cylindrical roller bearing Rodamiento de doble hilera de rodillos cilíndricos	
Characteristics Características										
Capacity of load Capacidad de carga	Radial loads Cargas radiales									
	Axial loads Cargas axiales									
	Combined loads Cargas combinadas									
High speed Alta velocidad										
High precision Alta precisión										
Couple and low noise Par y ruido bajos										
Rigidity Rigidez										
Angular disalignment Desalineamiento angular										
Capacity of alignment Capacidad de autoalineamiento										
Separable rings Aros separables										
End fixed bearing Rodamiento de extremo fijo										
End free bearing Rodamiento de extremo libre										
Bore ring inner tapered Agujero del aro interior cónico										

Excellent / Excelente
 Good / Bueno
 Acceptable / Aceptable
 Poor / Pobre
 Impossible / Imposible
 Single direction / Una sola dirección
 Double direction / Doble dirección

	Cylindrical roller bearing type NJ Rodamientos de rodillos cilíndricos con reborde simple	Cylindrical roller bearings with thrust collar Rodamientos de rodillos cilíndricos con collares de empuje	Needle roller bearings Rodamientos de agujas	Tapered roller bearings Rodamientos de rodillos cónicos	Double or multiple row tapered roller bearings Rodamientos de rodillos cónicos de doble o múltiple hilera	Spherical roller bearings Rodamientos de rodillos esféricos	Thrust ball bearing Rodamientos de bolas de empuje	Thrust ball bearing with washer Rodamientos de bolas de empuje con asiento de alineación	Thrust ball bearing angular contact Rodamientos de doble hilera de bolas de contacto angular	Cylindrical roller thrust bearings Rodamientos de rodillos cilíndricos de empuje	Tapered roller thrust bearings Rodamientos de rodillos cónicos de empuje	Spherical roller thrust bearings Rodamientos de rodillos esféricos de empuje
												
	●	●	●	●	●	●	×	×	×	×	×	○
	↔	↔	×	↔	↔	↔	↔	↔	↔	↔	↔	↔
	○	○	×	●	●	●	×	×	×	×	×	○
	●	●	●	○	○	○	×	×	○	○	○	○
				●			●		●			
	●	●	●	●	●				●	●	●	
	○	○	○	○	○	●	×	●	×	×	×	●
						☆		☆				☆
	☆	☆	☆	☆	☆		☆	☆	☆	☆	☆	☆
		☆			☆	☆						
			☆		★	★						
						☆						

☆ Applicable
Aplicable

★ Applicable with adjustment
Aplicable, pero es necesario permitir las contracciones / dilaciones del eje en las superficies de ajuste de los rodamientos

00.8 Table denominations / Tabla denominaciones

d		nominal bore diameter	diámetro de agujero nominal
dmp	$(dps_{max}+dps_{min})/2$	mean bore diameter	diámetro de agujero medio
dps max		largest bore diameter	diámetro de agujero máximo
dps min		smallest bore diameter	diámetro de agujero mínimo
Δ_{dmp}	dmp-d	deviation of mean bore diameter from nominal	desviación de diámetro de agujero medio del nominal
Vdp	dpsmax-dpsmin	variation of bore diameter (dpsmax-dpsmin)	variación de diámetro de agujero (dpsmax-dpsmin)
VDmp	dmpmax-dmpmin	variation of mean bore diameter	variación de diámetro de agujero medio
Kia		radial run out of inner ring	salto radial de aro interior
D		nominal outer diameter	diámetro exterior nominal
Dmp	$(Dps_{max}+Dps_{min})/2$	mean outer diameter	diámetro exterior medio
Dps max		largest outer diameter	diámetro exterior máximo
Dps min		smallest outer diameter	diámetro exterior mínimo
Δ_{Dmp}	Dmp-D	deviation of mean outer diameter from nominal	desviación del diámetro exterior medio del nominal
VDp	Dpsmax-Dpsmin	variation of outer diameter	variación de diámetro exterior
VDmp	Dmpmax-Dmpmin	variation of mean outer diameter	variación de diámetro exterior medio
Kea		radial run out of outer ring	salto radial de aro exterior
B		nominal inner ring width	altura nominal de aro interior
C		nominal outer ring width	altura nominal de aro exterior
Bs		single width of inner ring	altura simple de aro interior
Cs		single width of outer ring	altura simple de aro exterior
Δ_{Bs}	Bs-B	deviation of IR width from nominal	desviación de altura de AI de la nominal
Δ_{Cs}	Cs-C	deviation of OR width from nominal	desviación de altura de AE de la nominal
VBs	Bsmax-Bsmin	variation of inner ring width	variación de altura de aro interior
VCs	Csmax-Csmin	variation of outer ring width	variación de altura de aro exterior
Si		thickness variation of the ring for thrust bearings	variación de espesor de aro para rodamientos axiales
T		nominal total height of taper roller bearings	altura nominal total de rodamientos de rodillos cónicos
Ts		single height of taper roller bearings	altura simple de rodamientos de rodillos cónicos
Δ_{Ts}	Ts-T	deviation of width from nominal	desviación de altura de la nominal

Bearing type	ISO Diameter Series 7, 8, 9	0,1	2,3,4
Deep groove ball bearings Rodamientos de bolas	607,617,618,619,627, 628,637,638,639	60,160,161,630	2,3,42,43,62,63,64,622,623
Angular contact ball bearings Rodamientos de bolas de contacto angular			32,33,72,73,QJ 2,QJ 3
Cylindrical roller bearings Rodamientos cilíndricos		NU 10,20 NJ 10	NU 2,3,4,12,22,23;NJ 2,3,4,22,23; NUP 2,3,22,23;N 2,3

Product range index / Índice de gama de productos



1. Single row tapered roller bearings / Rodamientos de rodillos cónicos	76
1.0 Technical introduction / Introducción técnica	78
1.1 Metric series / Series métricas	92
1.2 Inch series / Series pulgadas	104
1.3 Special design bearings / Serie especial	150
1.4 Flange side bearings / Rodamientos con valona	154
1.5 U type bearings / Rodamientos tipo U	157
1.6 Steering bearings / Rodamientos de dirección	160
1.7 Inner rings / Conjuntos interiores	162
2. Double row tapered roller bearings / Rodamientos cónicos de doble hilera	164
2.0 Technical introduction / Introducción técnica	166
2.1 Double row tapered roller bearings / Rodamientos cónicos de doble hilera	170
3. Thrust tapered roller bearings / Rodamientos axiales cónicos	172
3.0 Technical introduction / Introducción técnica	174
3.1 Thrust tapered roller bearings / Rodamientos axiales cónicos	178
4. Deep groove ball bearings / Rodamientos radiales de bolas:	180
4.0 Technical introduction / Introducción técnica	182
4.1 Standard ball bearings / Rodamientos de bolas estándar	188
4.2 Special ball bearings / Rodamientos de bolas especiales	208
5. Angular contact ball bearings / Rodamientos de bolas de contacto angular:	210
5.0 Technical introduction / Introducción técnica	212
5.1 Double row angular contact ball bearings / Rodamientos de bolas de doble hilera de contacto angular	218
5.2 Standard double row angular contact ball bearings / Rodamientos de bolas de doble hilera de contacto angular estándar	224
5.3 Four point angular contact ball bearings / Rodamientos de bolas de contacto angular de cuatro puntos	226
5.4 Air conditioning / Aire acondicionado	230
6. Thrust ball bearings / Rodamientos axiales de bolas	232
6.0 Technical introduction / Introducción técnica	234
6.1 Thrust ball bearings / Rodamientos axiales de bolas	238
6.2 Clutch release bearing / Rodamientos de embrague	240
7. Cylindrical roller bearings / Rodamientos cilíndricos:	244
7.0 Technical introduction / Introducción técnica	246
7.1 Standard cylindrical bearings / Rodamientos cilíndricos estándar	252
7.2 Special cylindrical bearings / Rodamientos cilíndricos especiales	256
8. Commercial vehicle bearings / Rodamientos para vehículo industrial	262
8.0 Technical introduction / Introducción técnica	264
8.1 Hub wheel truck / Hub de rueda de camión	270
8.2 Kit wheel truck / Kit de rueda de camión	272
8.3 Compact wheel truck / Buje compacto de camión	274

01

Single row tapered roller bearings

Rodamientos de rodillos cónicos

01.0	Technical introduction / Introducción técnica	78
01.1	Metric series / Series métricas	92
01.2	Inch series / Series pulgadas	104
01.3	Special design bearings / Serie especial	150
01.4	Flange side bearings / Rodamientos con valona	154
01.5	U type bearings / Rodamientos tipo U	157
01.6	Steering bearings / Rodamientos de dirección	160
01.7	Inner rings / Conjuntos interiores	162

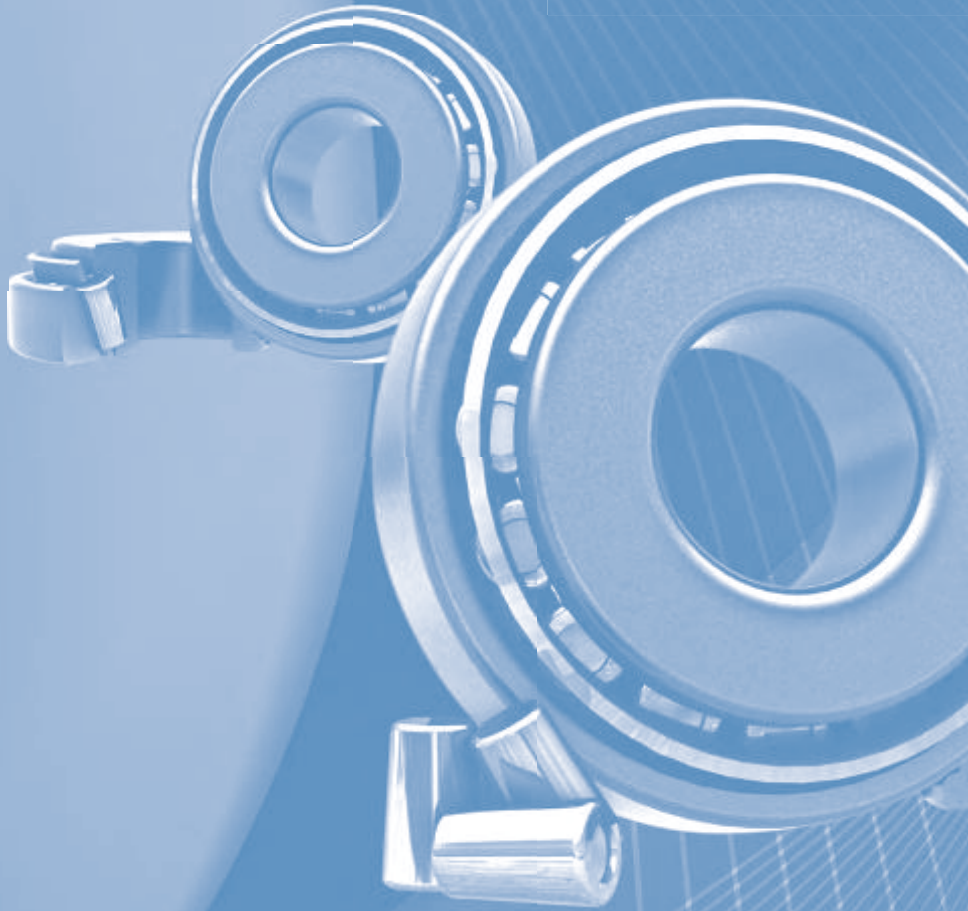

Product overview / Introducción

Description

Tapered roller bearings manufactured by Fersa Bearings are appropriate for supporting relatively large combined radial and axial thrusts.

Moreover, these bearings, due to their geometric shape, are always assembled in opposing pairs in order to counteract any force that tries to separate one of the bearings. The inclined raceways allow taper roller bearings to support axial loads and radial loads combined. The axial load capacity of the bearings is mostly set by the contact angle α .

Descripción

Los rodamientos de rodillos cónicos fabricados por Fersa Bearings son indicados para soportar cargas combinadas de empuje axial y radial relativamente grandes.

Además, debido a su forma geométrica estos rodamientos se montan siempre en parejas y contrapuestos para contrarrestar cualquier fuerza que intente separar uno de los rodamientos.

Las pistas de rodadura inclinadas permiten a los rodamientos de rodillos cónicos soportar cargas combinadas axiales y radiales. La capacidad de carga axial de los rodamientos está indicada por el ángulo de contacto α .

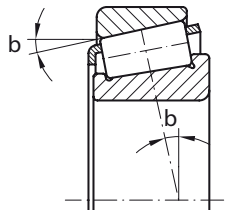

Smaller angles are more suitable for heavy radial loads while wider angles are suitable for heavy axial loads.

El ángulo cerrado permite una carga radial mayor, mientras que un ángulo más abierto permite una carga axial mayor.

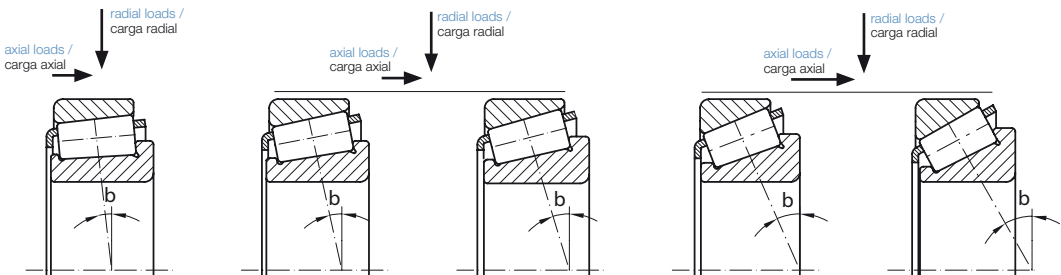



Design

Tapered roller bearings consist of 4 fundamental parts:

- Inner raceway
- Outer raceway
- Tapered rollers
- Cage

A characteristic feature of this type of bearing is that it is possible to separate the outer ring from the rest of the assembly, which facilitates its assembly.

In normal working conditions, the inner raceway, the outer raceway and the rollers are the ones in charge of sustaining the loads, while the function of the cage is just to keep the rollers uniformly separated.

Likewise, the interior design of the bearing in which the lines resulting from prolongation of the inner and outer raceway surfaces converge at a common point on the bearing rotation axis, which allows for the rollers to rotate without slipping on the raceways along the whole contact surface.

Diseño

Los rodamientos de rodillos cónicos tienen 4 partes fundamentales:

- Pista de rodadura interior
- Pista de rodadura exterior
- Rodillos cónicos
- Jaula

Una característica de este tipo de rodamientos es que se puede separar el aro exterior del resto de la disposición, facilitando así el montaje.

En condiciones de funcionamiento normales, la pista interior, la pista exterior y los rodillos son los encargados de soportar la carga, mientras que la jaula es para mantener los rodillos uniformemente separados.

De la misma forma, el diseño interior del rodamiento, en el cual la prolongación de las generatrices de la superficie de las pistas interior y exterior convergen en un punto común del eje de rotación del movimiento, permite a los rodillos el movimiento de rotación sin deslizamientos sobre las pistas a lo largo de toda la superficie de contacto.

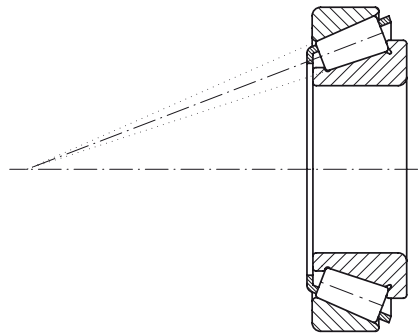

The total alignment of the rollers is one of main advantages of the tapered roller bearings. The conical geometry of the rollers not only gives a rolling movement without slipping with a load line (between raceway and rollers) but also a seating force between the large end of the roller and the rib of the cone. This seating force keeps the rollers aligned on the raceway surface.

La total alineación de los rodillos es una de las principales ventajas de los rodamientos de rodillos cónicos.

La geometría cónica de los rodillos, además de favorecer un movimiento de rotación con una línea de carga sin deslizamientos (entre las pistas y los rodillos), permite una fuerza de asentamiento entre la cabeza del rodillo y el labio del cono. Esta fuerza de asentamiento mantiene la alineación de los rodillos sobre la superficie de la pista.

Tapered roller bearings have a spherical surface in the large end of the rollers. Due to this design, when there is no load there is only a contact point between the roller and the rib while with loads, this contact point becomes an elliptical area.

Standard tapered roller bearings under normal working conditions provide a uniform stress distribution on the roller and raceways contacts. Modified profiles can be designed so as to increase operational reliability and reduced sensitivity to misalignment preventing edge stresses.

Los rodamientos de rodillos cónicos tienen una superficie esférica en la cabeza de los rodillos. Debido a este diseño, cuando no hay carga solo hay un punto de contacto entre el rodillo y la testa, mientras que con carga, este punto de contacto se convierte en un área elíptica.

En condiciones de funcionamiento normales, los rodamientos de rodillos cónicos estándar permiten una distribución de tensiones uniforme en los contactos de los rodillos y pistas.

Se pueden diseñar con perfiles modificados para incrementar la fiabilidad operacional y reducir la sensibilidad a la desalineación evitando tensión en los extremos.

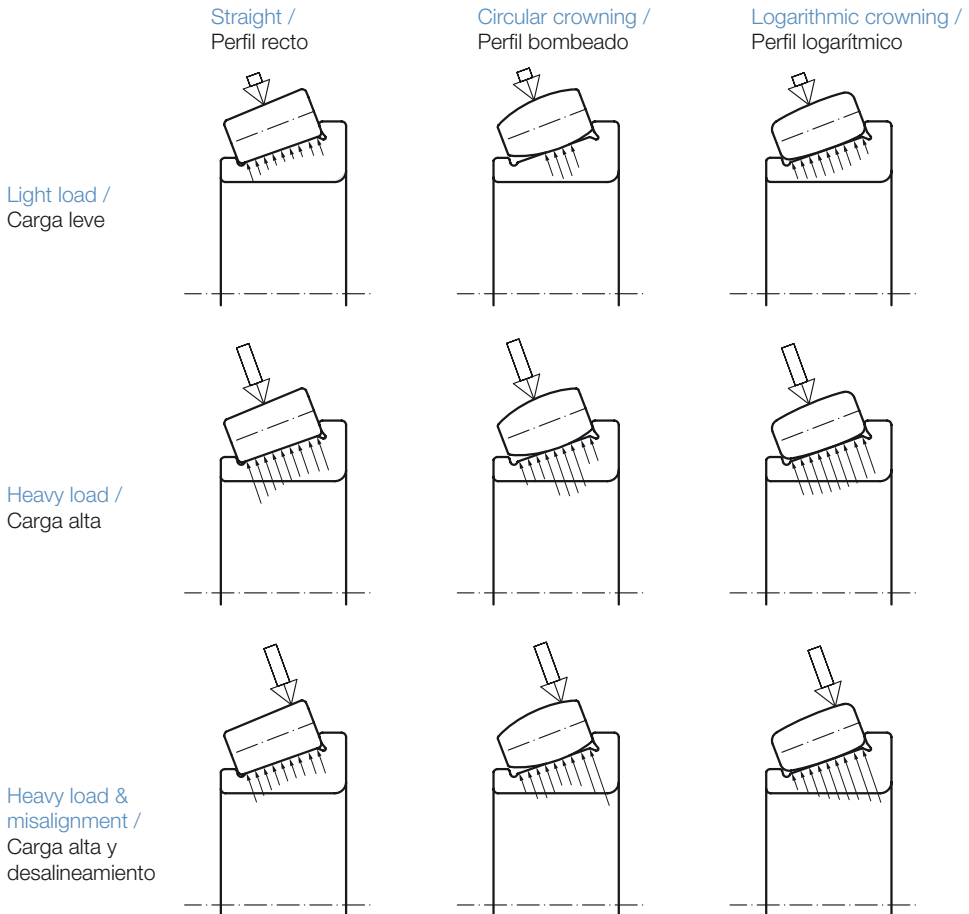



Bearing features / Características de los rodamientos

Tolerances

Fersa manufactures bearings called metric, which are perfectly standardized with tolerances in compliance with the ISO 492 International Standards, and bearings called inches in compliance with the International Standards ANSI ABMA Std. 19.2. Fersa also provides special Bearings subject to the specific needs of our clients, as well as other bearings different from those already previously.

The tolerances applied by Fersa to the metric bearings correspond to the ISO 492 Normal and 6X class.

The precision of a bearing is given by combining the main dimension tolerances and the operating tolerances, which refer to the deviations that may exist with the rotating parts.

The operating tolerances are based on the values of the following factors:

Kia – Radial deviation of the raceway of the inner ring.

Kea – Radial deviation of the raceway of the outer ring.

Tolerancias

Fersa fabrica rodamientos denominados métricos, que están perfectamente estandarizados con tolerancias de acuerdo con la Normativa Internacional ISO 492, y además rodamientos denominados pulgadas de acuerdo a la Normativa Internacional ANSI ABMA Std. 19.2. Fersa Bearings también fabrica rodamientos especiales, de acuerdo a las especificaciones particulares solicitadas por nuestros clientes, o que tienen otras especificaciones a las mencionadas anteriormente.

Las tolerancias aplicadas por Fersa a los rodamientos métricos son las correspondientes a las clases Normal y 6X según la norma ISO 492.

La precisión de un rodamiento viene dada por la combinación de las principales dimensiones de tolerancias y las tolerancias de funcionamiento, que hacen referencia a las desviaciones que puedan existir con las partes giratorias.

Las tolerancias de funcionamiento están basadas en los valores de los siguientes factores:

Kia – Desviación radial de la pista de rodadura del aro interior.

Kea – Desviación radial de la pista de rodadura del aro exterior.

a) Metric series / Serie métrica

Normal class / Clase Normal

Bore diameter / Diámetro interior

d		Δ_{dmp}		V_{dp}	V_{dmp}	K_{ia}
over	incl	high	low	max	max	max
mm		μm		μm	μm	μm
-	10	0	-12	12	9	15
10	18	0	-12	12	9	15
18	30	0	-12	12	9	18
30	50	0	-12	12	9	20
50	80	0	-15	15	11	25
80	120	0	-20	20	15	30
120	180	0	-25	25	19	35
180	250	0	-30	30	23	50

Outer diameter / Diámetro exterior

D		Δ_{Dmp}		V_{Dp}	V_{Dmp}	K_{ea}
over	incl	high	low	max	max	max
mm		μm		μm	μm	μm
-	18	0	-12	12	9	18
18	30	0	-12	12	9	18
30	50	0	-14	14	11	20
50	80	0	-16	16	12	25
80	120	0	-18	18	14	35
120	150	0	-20	20	15	40
150	180	0	-25	25	19	45
180	250	0	-30	30	23	50
250	315	0	-35	35	26	60
315	400	0	-40	40	30	70

Bearing width (normal class) / Anchura del rodamiento (clase normal)

d		Δ_{Bs}		Δ_{Cs}		Δ_{Ts}	
over	incl	high	low	high	low	high	low
mm		μm		μm	μm	μm	μm
-	10	0	-120	0	-120	200	0
10	18	0	-120	0	-120	200	0
18	30	0	-120	0	-120	200	0
30	50	0	-120	0	-120	200	0
50	80	0	-150	0	-150	200	0
80	120	0	-200	0	-200	200	-200
120	180	0	-250	0	-250	350	-250
180	250	0	-300	0	-300	350	-250

P6X class / P6X Clase

width (P6X class) / Anchura (clase P6X)

d		Δ_{Bs}		Δ_{Cs}		Δ_{Ts}	
over	incl	high	low	high	low	high	low
mm		μm		μm	μm	μm	μm
-	10	0	-50	0	-100	100	0
10	18	0	-50	0	-100	100	0
18	30	0	-50	0	-100	100	0
30	50	0	-50	0	-100	100	0
50	80	0	-50	0	-100	100	0
80	120	0	-50	0	-100	100	0
120	180	0	-50	0	-100	150	0
180	250	0	-50	0	-100	150	0

B) Inch series (normal class) / Series pulgadas (clase normal)

Bore diameter / Diámetro interior

d		Δ_{dmp}		Δ_{Bs}		K_{ia}
over	incl	high	low	high	low	max
mm		μm		μm		μm
-	76,2	13	0	76	-254	51
76,200	152,400	25	0	76	-254	51
152,400	304,800	25	0	-	-	51
304,800	609,600	51	0	-	-	51
609,600	-	76	0	-	-	76

Outer diameter / Diámetro exterior

D		Δ_{Dmp}		Δ_{Cs}		K_{ea}
over	incl	high	low	high	low	max
mm		μm		μm		μm
-	101,600	25	0	51	-254	51
101,600	304,800	25	0	51	-254	51
304,800	355,600	51	0	51	-254	51
355,600	609,600	51	0	-	-	51
609,600	-	76	0	-	-	76

width (normal class) / Anchura (clase normal)

d		Δ_{Ts}	
over	incl	high	low
mm		μm	μm
-	101,6	203	0
101,600	304,800	356	-254
304,800	609,600	381	-381
609,600	-	381	-381

Misalignment

Misalignment is defined, in tapered roller bearing, as the angle between the bearing cone assembly axis and the cup axis.

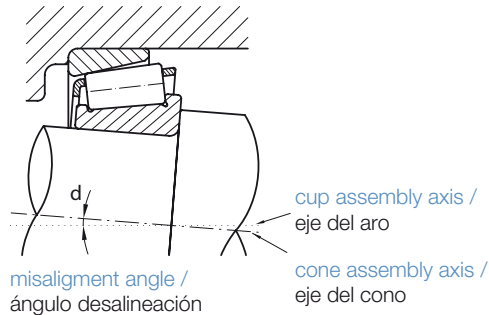

Desalineación

La desalineación en los rodamientos de rodillos cónicos se define como la diferencia de ángulo entre el eje del cono montado y el eje del aro.

The ability of tapered roller bearings to accommodate angular misalignment of the inner ring with respect to the outer ring is limited to a few minutes.

La capacidad de los rodamientos de rodillos cónicos de soportar una desalineación angular del aro interior con respecto al aro exterior se limita a unos minutos.

Internal clearance

In tapered roller bearings, the axial internal clearance is the result of mounting against a second bearing during installation. Therefore internal clearance of single row tapered roller bearings can only be obtained after mounting and it is determined by adjustment of the bearing against a second bearing, which provides location in the opposite direction.

Juego Interior

En los rodamientos de rodillos cónicos, el juego axial interior solo se puede obtener tras el montaje y se determina por el ajuste de un rodamiento contra un segundo rodamiento, que permite una fijación en la dirección opuesta.

Speed

Tapered rollers bearings speed can be express as:

- a) Thermal reference speed.

It is the permissible operational speed of a bearing subjected to a certain load and running with a certain lubricant viscosity according to the ISO 15312. In these specific conditions, there is equilibrium between the heat that is generated by the bearing and the heat that is dissipated from the bearing to the shaft, housing and lubricant.

Velocidad

La velocidad de los rodamientos de rodillos cónicos se puede expresar de la siguiente manera:

- a) Velocidad termal.

Es la velocidad funcional permitida de un rodamiento sometido a una carga determinada y que está funcionando con una viscosidad de lubricante determinada de acuerdo a la Normativa ISO 15312. Bajo estas condiciones específicas hay un equilibrio entre el calor generado por el rodamiento y el calor que se disipa del rodamiento al eje, caja y lubricante.

b) Speed limit

The speed limit is based on practical experience and laboratory tests that takes into account the strength of the cage, lubrication, sealing function and centrifugal forces.

Cages

Fersa is able to supply cages made of different materials:

- Pressed steel.
- Synthetic materials such as polyamide P_A 66.



Pressed steel / Acero prensado

Equivalent dynamic bearing load

The nominal capacity of the radial dynamic load C_r is the radial load with constant intensity and direction that a bearing can theoretically support for a nominal duration of 1 million revolutions (ISO 281). Its value for each bearing is determined in the Fersa catalogues.

In most cases, the loads applicable to the bearings are a combination of radial and axial loads which, moreover, fluctuate in magnitude and direction. Because of this, in order to calculate the service life of a bearing, an equivalent dynamic load must be calculated using the following formula:

$$Pr = X Fr + Y Fa$$

The values of the X and Y factors are given in the Fersa catalogue, accompanying each reference.

b) Límite de velocidad

El límite de velocidad se basa en la experiencia práctica y en las pruebas de laboratorio que toman en cuenta la solidez de la caja, el lubricante, la función de obturación y las fuerzas centrifugales.

Jaulas

Fersa puede suministrar jaulas en diferentes materiales:

- Acero prensado.
- Materiales sintéticos, como la poliamida P_A 66.

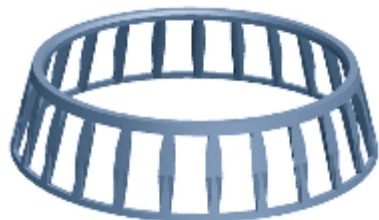

Synthetic material/ Materiales sintéticos

Carga dinámica equivalente de rodamiento

La capacidad nominal de carga dinámica radial C_r es la carga radial con intensidad y dirección constante que puede soportar teóricamente un rodamiento por una duración nominal de 1 millón de revoluciones (ISO 281). El valor para cada rodamiento viene determinado en los catálogos Fersa.

En la mayoría de los casos, las cargas aplicadas a los rodamientos son una combinación de cargas radiales y axiales que, además, fluctúan en magnitud y dirección. Debido a esto, para calcular la vida útil de un rodamiento, se debe calcular la carga dinámica equivalente utilizando la siguiente fórmula:

$$Pr = X Fr + Y Fa$$

Los valores de los factores X e Y vienen especificados, junto a cada referencia, en los catálogos de Fersa.

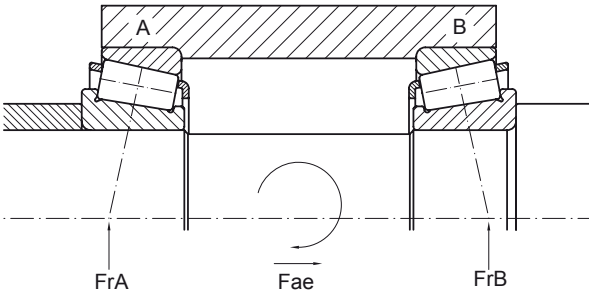

Axle load 2 conditions

Condición de carga axial 2

$$\frac{0,5 F_{rA}}{Y_A} > \frac{0,5 F_{rB}}{Y_B} + F_{ae}$$

Total axle load on the bearing

Carga axial total sobre el rodamiento

$$F_{aA} = \frac{0,5 F_{rA}}{Y_A}$$

$$F_{aB} = \frac{0,5 F_{rA}}{Y_A} + F_{ae}$$

Equivalent dynamic radial load

Carga radial dinámica equivalente

$$P_A = F_{rA}$$

$$\text{Si } \frac{F_{aB}}{F_{rB}} \leq e_B, P_B = F_{rB}$$

$$F_{oA} = \frac{0,5 F_{rA}}{Y_A}$$

$$\text{Si } \frac{F_{aB}}{F_{rB}} > e_B$$

$$P_B = 0,4 F_{rB} + Y_B F_{aB}$$

Axle load 1 conditions

Condición de carga axial 1

$$\frac{0,5 F_{rA}}{F_{ae} Y_A} \leq \frac{0,5 F_{rB}}{Y_B}$$

Total axle load on the bearing

Carga axial total sobre el rodamiento

$$F_{aA} = \frac{0,5 F_{rB}}{F_{ae} Y_B}$$

$$F_{aB} = \frac{0,5 F_{rB}}{Y_B}$$

Equivalent dynamic radial load

Carga radial dinámica equivalente

$$\text{Si } \frac{F_{aA}}{F_{rA}} \leq e_A$$

$$P_A = F_{rA}$$

$$\text{Si } \frac{F_{aA}}{F_{rA}} > e_A$$

$$P_A = 0,4 F_{rA} + Y_A F_{aA}$$

$$P_B = F_{rB}$$

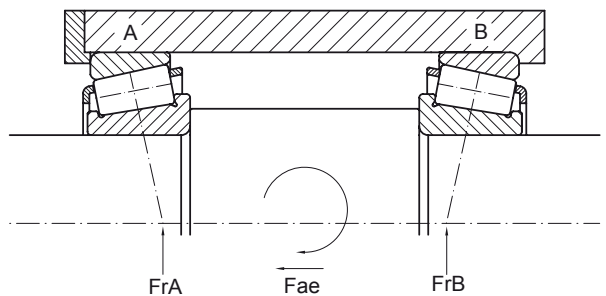

Equivalent static bearing load

When a bearing is subject to an excessive load, or to a large impulse load which surpasses the elastic limit, permanent local deformations may be produced on the raceway surfaces.

The value that regulates this possibility is the nominal capacity of the radial static load C_{or} , and is defined as the radial static load that corresponds to the calculation of a reaction in the centre of the roller contact / most loaded path equal to 4000 MPa (ISO 76).

There also exists an equivalent static load, due to the variety of possibilities of load application, with the formula:

$$P_{or} = X_o F_r + Y_o F_r$$

There are different restrictive factors to be kept in mind in more extreme situations such as: high temperatures, reduction due to hardness of shafts and housings, of impact, of safety, etc.

The suitability of a bearing selected for heavily loaded applications should be checked to ensure that its basic static load rating is adequate. This can be determined with the aid of the static safety factor S_o , which is given by the equation:

$$S_o = C_o / P_o$$

where:

- C_o = basic static load rating [kN]
- P_o = equivalent static bearing load [kN]
- S_o = static safety factor

Where the bearing is dynamically loaded and the selection has been made on the basis of life, it is also advisable to check that the basic static load rating is adequate for attaining the performance requirements of the application.

Guideline values of S_o for various types of operation and application requirements regarding smooth and vibration free running are applicable to rotating bearings and are based on experience: T 3.1.3.

Carga estática equivalente del rodamiento

Cuando un rodamiento está sometido a una carga excesiva, o a una carga de inercia grande que sobrepasa el límite de elasticidad, se pueden producir deformaciones permanentes en la pista de rodadura.

El valor que regula esto es la capacidad nominal de la carga radial estática C_{or} , y se define como la carga radial estática correspondiente al cálculo de una reacción en el centro del contacto del rodillo / camino más cargado igual a 4000 MPa (ISO 76).

También existe un equivalente a la carga estática debido a la variedad de posibilidades de la aplicación de la carga, con la fórmula:

$$P_{or} = X_o F_r + Y_o F_r$$

En cuanto a las situaciones más extremas se deben tener en cuenta factores restrictivos diferentes, tales como: temperaturas altas, reducción de caja y ejes debido a la dureza, el impacto, la seguridad, etc.

Se debe de confirmar la idoneidad de un rodamiento seleccionado para aplicaciones de cargas muy grandes, para asegurar que la referencia de carga estática básica es la adecuada. Esto se puede determinar con la ayuda del factor de seguridad estática S_o , que viene dado por la ecuación:

$$S_o = C_o / P_o$$

donde:

- C_o = referencia de carga estática básica [kN]
- P_o = carga estática equivalente de rodamiento [kN]
- S_o = actor estático de seguridad

Cuando el rodamiento está cargado dinámicamente y la selección se ha hecho en base a la vida útil del rodamiento, también se aconseja comprobar que la referencia de carga estática es la adecuada para lograr los requisitos de funcionamiento de la aplicación.

Valores recomendados para S_o según los requisitos de varios tipos de funcionamiento y aplicación con respecto a un funcionamiento suave y sin vibraciones son aplicables a los rodamientos de rotación y se basan en la experiencia: T 3.1.3.

Type of operation / Tipo de operación	S_o min
Quiet running applications: smooth-running, vibration, high rotational accuracy Aplicaciones ligeras: rodaje suave, sin vibraciones, alta precisión de giro.	3
Normal-running applications: smooth-running, vibration-free, normal rotational accuracy Aplicaciones normales: rodaje suave, sin vibraciones, precisión de giro normal.	1,5
Applications subjected to shock loads: pronounced shock loads a Aplicaciones sujetas a impactos: cargas continuadas de golpes	3

Designation (prefix, suffix)

1 Metric

a) Initial Nomenclature:

- Included by the ISO 15 Standard.
- Only one reference to identify cup and cone

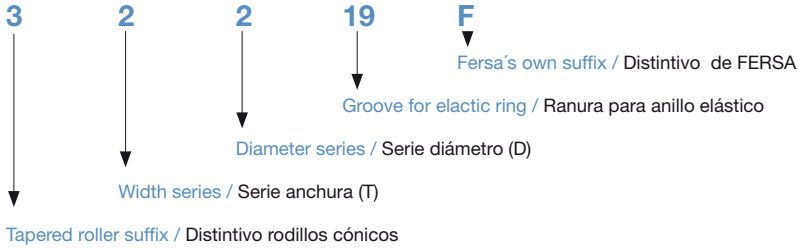

b) New nomenclature (ISO 355 Standard)

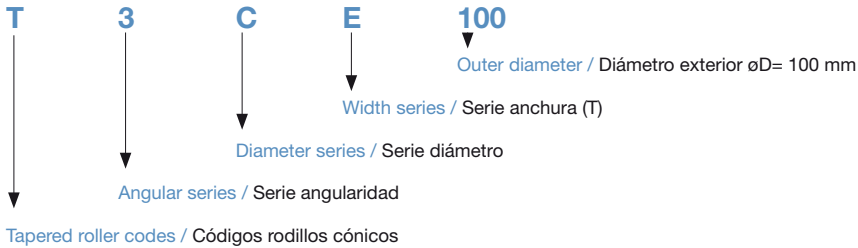

Designación (prefijo, sufijo)

1 Métricos

a) Nomenclatura original:

- Recogida en la norma ISO 15.
- Una única referencia para identificar aro y cono

b) Nueva nomenclatura (Norma ISO 355)

Diameter series Serie diámetro	$D/d^{0.77}$	
B	3,4	3,8
C	3,8	4,4
D	4,4	4,7
E	4,7	5
F	5	5,6
G	5,6	7

Angular series Serie angularidad	a	
2	10°	13°52'
3	13°	15° 59'
4	15° 59'	18°55'
5	18° 55'	23'
6	23°	27'
7	27°	30'

Width Serie anchura	$T/(D-d)^{0.95}$	
B	0,5	0,68
C	0,68	0,8
D	0,8	0,88
E	0,88	1

c) "New" metric series nomenclature:

- New series for bearings included in the ISO 355 Standard.
- Dimensions with metric measurements.
- Combined nomenclature with the ABMA inches system.

c) Nomenclatura "nuevas" series de métricos:

- Nuevas series de rodamientos incluidos en la norma ISO 355.
- Dimensiones con cotas métricas.
- Nomenclatura combinada con el sistema de numeración en pulgadas ABMA.

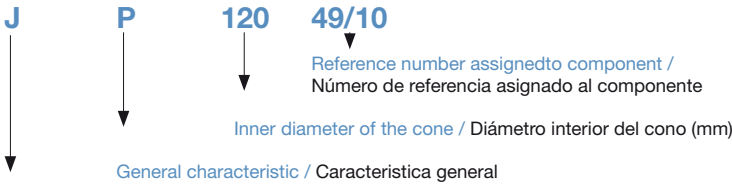

Reference number assigns to the component / Identificación de los nuevos rodamientos con dimensiones y tolerancias métricas

General characteristic / Característica general	
C,D,K	For general industrial application / Para aplicaciones industriales en general
N	For general and head application pinions industrial / Para aplicaciones industriales en general y piñones de ataque
P	For high speed / Para alta velocidad
S,T	For head pinions / Para piñones de ataque
W	For heavy axial loads / Para grandes cargas axiales

2 Inches:

- Combination of an initial nomenclature developed and the subsequent ANSI ABMA 19.2 Standard.
- Any inner set can be assembled with a ring from the same series, that is the reason why the cone and the cup have individual designations.
- Depending on the loads to be supported, the variation of the amount of rollers and raceways angles can generate a whole new assortment of bearings: radial (smaller angles) or axial (wider angles).
- The term "bearing series" is used to describe bearings having the same basic internal geometry (roller size, inner raceway and outer race angle). Any inner raceway (including roller set) can be matched with any outer raceway within the same series providing that the same type of bearing is being used.
- The series are defined with a series of digits that go between 3 digits (initial nomenclature) to 6 digits (ABMA).

2 Pulgadas:

- Mezcla de una nomenclatura original desarrollada inicialmente y la norma ANSI ABMA 19.2 posterior.
- Cualquier conjunto interior puede montarse con cualquier aro de la misma serie. Por este motivo, el cono y el aro cuentan con designaciones individuales.
- Variando la cantidad de rodillos y los ángulos de las pistas, pueden generarse toda una gama de rodamientos según las cargas que tuvieran que soportar: radiales (ángulos más cerrados) o axiales (ángulos más abiertos).
- El término "series de rodamientos" se usa para describir los rodamientos que tienen la misma geometría interna (conjunto de rodillos y ángulo de pista interior y exterior). Toda pista interior (incluido un conjunto de rodillo) puede ajustarse a una pista exterior dentro de la misma serie, siempre que se utilice el mismo tipo de rodamiento.
- Las series están definidas por entre 3 (nomenclatura original) y 6 (ABMA) dígitos.

01.1

METRIC SERIES SERIES MÉTRICAS

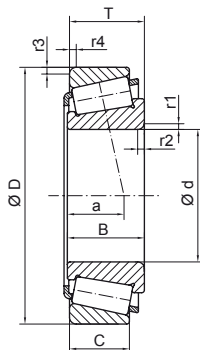

DIMENSIONS / DIMENSIONES													ISO REF / REF ISO	REFERENCES / REFERENCIAS
d		D		T		B		C		r1/r2 min	r3/r4 min	a		
mm	inch	mm	inch	mm	inch	mm	inch	mm	inch	mm	mm	mm		
15,000	0,591	35,000	1,378	11,750	0,463	11,000	0,433	10,000	0,394	1,0	1,0	8,3	---	30202 F
		42,000	1,654	14,250	0,561	13,000	0,512	11,000	0,433	1,0	1,0	9,6	T2FB015	30302 F
17,000	0,669	40,000	1,575	13,250	0,522	12,000	0,472	11,000	0,433	1,0	1,0	9,9	T2DB017	30203 F
		47,000	1,850	15,250	0,600	14,000	0,551	12,000	0,472	1,0	1,0	10,0	T2FB017	30303 F
		47,000	1,850	15,250	0,600	14,000	0,551	10,500	0,413	1,5	1,5	15,9	---	31303 F
		47,000	1,850	20,250	0,797	19,000	0,748	16,000	0,630	1,0	1,0	12,0	T2FD017	32303 F
20,000	0,787	42,000	1,654	15,000	0,591	15,000	0,591	12,000	0,472	0,6	0,6	10,0	T3CC020	32004 XF
		42,000	1,654	15,000	0,591	15,000	0,591	12,000	0,472	3,0	0,6	10,0	---	32004 XR
		47,000	1,850	15,250	0,600	14,000	0,551	12,000	0,472	1,0	1,0	11,0	T2DB020	30204 F
		47,000	1,850	19,250	0,758	18,000	0,709	15,000	0,591	1,0	1,0	12,6	T2DD020	32204 F
		47,000	1,850	19,250	0,758	18,000	0,709	13,000	0,512	0,3	0,5	12,6	---	32204 FR
		52,000	2,047	16,250	0,640	15,000	0,591	13,000	0,512	1,5	1,5	11,0	T2FB020	30304 F
		52,000	2,047	22,250	0,876	21,000	0,827	18,000	0,709	1,5	1,5	14,0	T2FD020	32304 F
22,000	0,866	44,000	1,732	15,000	0,591	15,000	0,591	11,500	0,453	0,6	0,6	11,0	---	320/22 XF
25,000	0,984	47,000	1,850	15,000	0,591	15,000	0,591	11,500	0,453	0,6	0,6	11,6	T4CC025	32005 XF
		47,000	1,850	15,000	0,591	15,000	0,591	11,500	0,453	4,5	1,0	11,6	---	32005 XR
		52,000	2,047	16,250	0,640	15,000	0,591	13,000	0,512	3,5	1,0	12,0	---	30205 FR
		52,000	2,047	16,250	0,640	15,000	0,591	13,000	0,512	1,0	1,0	12,0	T3CC025	30205 F
		52,000	2,047	19,250	0,758	18,000	0,709	16,000	0,630	1,0	1,0	13,5	T2CD025	32205 F
		52,000	2,047	19,250	0,758	18,000	0,709	15,000	0,591	1,0	1,0	16,0	T5CD025	32205 BF
		52,000	2,047	22,000	0,866	22,000	0,866	18,000	0,709	1,0	1,0	14,1	T2DE025	33205 F
		62,000	2,441	18,250	0,719	17,000	0,669	15,000	0,591	1,5	1,5	13,1	T2FB025	30305 F
		62,000	2,441	18,250	0,719	17,000	0,669	13,000	0,512	1,5	1,5	20,0	T7FB025	31305 F
62,000	2,441	25,250	0,994	24,000	0,945	20,000	0,787	1,5	1,5	15,6	T2FD025	32305 F		
28,000	1,102	52,000	2,047	16,000	0,630	16,000	0,630	12,000	0,472	1,0	1,0	13,0	T4CC028	320/28 XF
		68,000	2,677	19,750	0,778	18,000	0,709	16,000	0,630	1,5	1,5	14,1	---	303/28 F
30,000	1,181	55,000	2,165	17,000	0,669	17,000	0,669	13,000	0,512	1,0	1,0	13,4	T4CC030	32006 XF
		55,000	2,165	20,000	0,787	20,000	0,787	16,000	0,630	1,0	1,0	13,0	T2CE030	33006 F
		62,000	2,441	17,250	0,679	16,000	0,630	14,000	0,551	1,0	1,0	13,9	T3DB030	30206 F
		62,000	2,441	18,000	0,709	18,000	0,709	14,000	0,551	1,0	1,0	15,5	---	32007 X 30/32007 XF
		62,000	2,441	21,250	0,837	20,000	0,787	17,000	0,669	1,0	1,0	15,5	T3DC030	32206 F
		62,000	2,441	25,000	0,984	25,000	0,984	19,500	0,768	1,0	1,0	16,0	T2DE030	33206 F

Assembly / Montaje

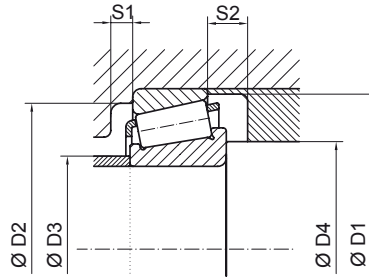

WEIGHT / PESO		ASSEMBLY / MONTAJE							LOAD / CARGA		LOAD FACTORS / FACTORES DE CARGA			SPEED / VELOCIDAD		REFERENCES / REFERENCIAS
		D1 min	D2 min	D2 max	D3 max	D4 min	S1	S2	Dynamic / Dinámica	Static / Estática	Dynamics / Dinámicos	Statics / Estáticos	Yo	Oil / Aceite	Grease / Grasa	
kg	lb	mm	mm	mm	mm	mm	mm	mm	C	Co	e	Y	Yo	na	ng	
0,05	0,11	32,0	30,0	30,0	20,0	19,0	2,0	1,5	15,4	15,0	0,32	1,88	1,04	16000	11900	30202 F
0,10	0,21	38,0	36,5	36,0	22,0	21,0	2,0	3,0	26,9	27,0	0,28	2,10	1,15	13800	10200	30302 F
0,08	0,17	37,0	34,5	35,0	23,5	20,8	2,0	2,0	21,7	21,2	0,34	1,74	0,95	13700	10100	30203 F
0,13	0,29	42,0	40,5	42,0	25,0	21,0	3,0	3,0	32,9	30,5	0,28	2,10	1,15	12300	9100	30303 F
0,13	0,28	45,0	36,0	41,0	27,0	23,0	3,0	4,5	23,3	23,7	0,83	0,73	0,40	12500	9300	31303 F
0,17	0,37	43,0	39,5	41,0	24,0	21,0	3,0	4,0	39,7	39,2	0,28	2,10	1,15	12300	9100	32303 F
0,10	0,22	39,0	36,0	38,0	25,0	23,0	3,0	3,0	27,6	31,3	0,37	1,60	0,88	12500	9300	32004 XF
0,10	0,22	39,0	36,0	38,0	25,0	23,0	3,0	3,0	27,6	31,3	0,37	1,60	0,88	12500	9300	32004 XR
0,12	0,26	43,0	40,5	42,0	27,0	24,0	2,0	3,0	32,5	33,8	0,34	1,74	0,95	11600	8600	30204 F
0,16	0,35	43,0	39,0	42,0	27,5	24,0	2,0	4,0	40,9	44,3	0,33	1,81	1,00	11700	8700	32204 F
0,16	0,35	43,0	39,0	42,0	27,5	24,0	2,0	4,0	40,9	44,3	0,33	1,81	1,00	11700	8700	32204 FR
0,17	0,37	47,0	44,5	46,0	28,0	26,0	3,0	3,0	39,9	38,9	0,30	2,00	1,10	10900	8100	30304 F
0,23	0,51	47,0	42,5	46,0	27,0	26,0	3,0	4,0	49,7	52,0	0,30	2,00	1,10	10900	8100	32304 F
0,11	0,23	38,5	38,0	40,0	27,0	25,0	3,0	3,5	29,4	33,8	0,39	1,51	0,83	11700	8700	320/22 XF
0,11	0,24	44,0	40,5	42,5	30,0	29,2	3,0	3,5	30,7	37,8	0,43	1,39	0,76	10700	7900	32005 XF
0,11	0,24	44,0	40,5	42,5	30,0	32,0	3,0	3,5	30,7	37,8	0,43	1,39	0,76	10700	7900	32005 XR
0,15	0,33	48,0	40,5	47,0	31,0	29,0	2,0	3,0	37,7	42,9	0,37	1,60	0,88	10700	7900	30205 FR
0,15	0,33	48,0	44,5	47,0	31,0	29,0	2,0	3,0	37,7	42,9	0,37	1,60	0,88	10100	7500	30205 F
0,19	0,41	49,0	44,5	47,0	31,0	29,0	2,0	3,0	38,7	44,9	0,37	1,60	0,88	10100	7500	32205 F
0,19	0,42	49,0	41,0	47,0	31,0	29,0	2,0	4,0	42,0	51,8	0,58	1,03	0,57	9700	7200	32205 BF
0,22	0,47	49,0	43,5	46,0	30,0	31,0	4,0	4,0	49,0	57,9	0,35	1,71	0,94	10100	7500	33205 F
0,26	0,57	57,0	54,0	54,5	34,0	32,5	3,0	3,0	52,8	51,7	0,30	2,00	1,10	9000	6700	30305 F
0,26	0,57	59,0	47,5	56,0	34,0	31,0	3,0	5,0	46,1	50,1	0,82	0,72	0,40	8100	6000	31305 F
0,36	0,79	57,0	52,0	54,5	33,5	32,5	3,0	5,0	67,9	71,9	0,30	2,00	1,10	9000	6700	32305 F
0,15	0,32	49,0	45,0	47,0	33,0	32,0	3,0	4,0	37,6	43,6	0,43	1,39	0,76	9600	7100	320/28 XF
0,35	0,76	61,5	57,5	62,0	37,5	34,0	3,0	3,5	58,8	58,4	0,30	1,96	1,07	8200	6100	303/28 F
0,17	0,37	52,0	47,5	49,0	35,5	34,2	3,0	4,0	42,1	53,2	0,43	1,39	0,76	9000	6700	32006 XF
0,20	0,44	46,0	48,5	50,0	35,5	34,0	3,0	4,0	47,0	59,9	0,29	2,05	1,13	9200	6800	33006 F
0,22	0,49	57,0	53,0	56,0	37,5	36,0	2,0	3,0	47,6	52,6	0,37	1,60	0,88	8400	6200	30206 F
0,26	0,56	58,0	53,5	56,0	41,0	36,0	4,0	4,0	40,4	52,7	0,44	1,35	0,74	8300	6200	32007 X 30/32007 XF
0,28	0,62	59,0	52,0	56,0	37,0	36,0	2,5	4,0	57,2	66,6	0,37	1,60	0,88	8400	6200	32206 F
0,36	0,79	59,0	52,5	57,0	36,0	34,0	5,0	5,5	72,3	86,1	0,34	1,75	0,97	8500	6300	33206 F

01.1

METRIC SERIES SERIES MÉTRICAS

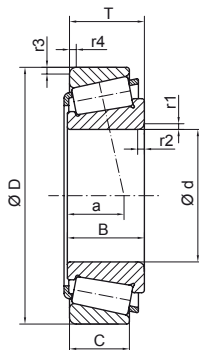
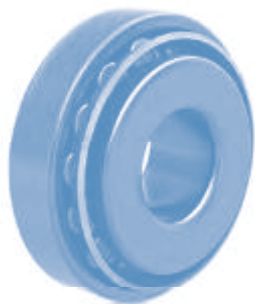

DIMENSIONS / DIMENSIONES													ISO REF / REF ISO	REFERENCES / REFERENCIAS
d		D		T		B		C		r1/r2 min	r3/r4 min	a		
mm	inch	mm	inch	mm	inch	mm	inch	mm	inch	mm	mm	mm		
30,000	1,181	72,000	2,835	20,750	0,817	19,000	0,748	16,000	0,630	1,5	1,5	15,0	T2FB030	30306 F
		72,000	2,835	20,750	0,817	19,000	0,748	14,000	0,551	1,5	1,5	22,0	T7FB030	31306 F
		72,000	2,835	28,750	1,132	27,000	1,063	23,000	0,906	1,5	1,5	22,0	T5FD030	32306 BF
		72,000	2,835	28,750	1,132	27,000	1,063	23,000	0,906	2,0	2,0	22,8	---	32306 C
		72,000	2,835	28,750	1,132	27,000	1,063	23,000	0,906	1,5	1,5	18,8	T2FD030	32306 F
32,000	1,260	58,000	2,283	17,000	0,669	17,000	0,669	13,000	0,512	1,0	1,0	14,0	T4CC032	320/32 XF
		58,000	2,283	17,000	0,669	17,000	0,669	13,000	0,512	4,5	1,0	14,0	---	320/32 XR
		65,000	2,559	26,000	1,024	26,000	1,024	20,500	0,807	1,0	1,0	16,7	T2DE032	332/32 F
34,000	1,339	62,000	2,441	18,000	0,709	18,000	0,709	14,000	0,551	1,0	1,0	15,5	---	32007 X 34/ 32007 XF
35,000	1,378	62,000	2,441	18,000	0,709	18,000	0,709	14,000	0,551	1,0	1,0	15,5	T4CC035	32007 XF
		62,000	2,441	18,000	0,709	18,000	0,709	14,000	0,551	4,5	1,0	15,5	---	32007 XR
		62,000	2,441	21,000	0,827	21,000	0,827	17,000	0,669	1,0	1,0	14,0	T2CE035	33007 F
		72,000	2,835	18,250	0,719	17,000	0,669	15,000	0,591	1,5	1,5	15,0	T3DB035	30207 F
		72,000	2,835	24,250	0,955	23,000	0,906	19,000	0,748	1,5	1,5	17,8	T3DC035	32207 F
		72,000	2,835	28,000	1,102	28,000	1,102	22,000	0,866	1,5	1,5	18,0	T2DE035	33207 F
		80,000	3,150	18,250	0,719	17,000	0,669	15,000	0,591	1,5	1,5	15,3	---	30207/80 F
		80,000	3,150	22,750	0,896	21,000	0,827	18,000	0,709	2,0	1,5	16,6	T2FB035	30307 F
		80,000	3,150	22,750	0,896	21,000	0,827	15,000	0,591	2,0	1,5	25,2	T7FB035	31307 F
80,000	3,150	32,750	1,289	31,000	1,220	25,000	0,984	2,0	1,5	20,3	T2FE035	32307 F		
37,000	1,457	72,000	2,835	18,250	0,719	17,000	0,669	15,000	0,591	1,5	1,5	15,3	---	30207/37 F
38,000	1,496	90,000	3,543	35,250	1,388	33,000	1,299	27,000	1,063	2,0	1,5	23,3	---	323/38 F
40,000	1,575	68,000	2,677	19,000	0,748	19,000	0,748	14,500	0,571	1,0	1,0	15,0	T3CD040	32008 XF
		68,000	2,677	22,000	0,866	22,000	0,866	18,000	0,709	1,0	1,0	14,7	T2BE040	33008 F
		75,000	2,953	26,000	1,024	26,000	1,024	20,500	0,807	1,5	1,5	18,0	T2CE040	33108 F
		80,000	3,150	19,750	0,778	18,000	0,709	16,000	0,630	1,5	1,5	16,5	T3DB040	30208 F
		80,000	3,150	24,750	0,974	23,000	0,906	19,000	0,748	1,5	1,5	19,0	T3DC040	32208 F
		80,000	3,150	32,000	1,260	32,000	1,260	25,000	0,984	1,5	1,5	20,7	T2DE040	33208 F
		90,000	3,543	25,250	0,994	23,000	0,906	20,000	0,787	2,0	1,5	18,9	T2FB040	30308 F
		90,000	3,543	25,250	0,994	23,000	0,906	17,000	0,669	2,0	1,5	28,3	T7FB040	31308 F
		90,000	3,543	35,250	1,388	33,000	1,299	26,000	1,024	2,0	1,5	27,8	---	32308 C
		90,000	3,543	35,250	1,388	33,000	1,299	27,000	1,063	2,0	1,5	23,3	T2FD040	32308 F
		90,000	3,543	35,250	1,388	33,000	1,299	27,000	1,063	2,0	1,5	27,8	T5FD040	32308 BF

Assembly / Montaje

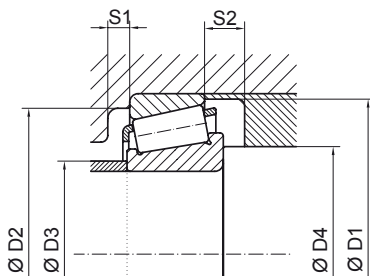

WEIGHT / PESO		ASSEMBLY / MONTAJE							LOAD / CARGA		LOAD FACTORS / FACTORES DE CARGA			SPEED / VELOCIDAD		REFERENCES / REFERENCIAS
		D1 min	D2 min	D2 max	D3 max	D4 min	S1	S2	Dynamic / Dinámica	Static / Estática	Dynamics / Dinámicos	Statics / Estáticos	Yo	Oil / Aceite	Grease / Grasa	
kg	lb	mm	mm	mm	mm	mm	mm	mm	C	Co	e	Y	Yo	na	ng	
0,39	0,86	66,0	61,5	64,5	40,0	37,5	3,0	4,5	65,8	67,2	0,31	1,90	1,04	7700	5700	30306 F
0,39	0,86	68,0	55,0	66,0	40,0	36,0	3,0	6,5	57,6	63,2	0,82	0,72	0,40	6900	5100	31306 F
0,58	1,28	66,0	53,5	66,0	39,0	36,0	3,0	5,5	85,0	100,4	0,55	1,10	0,60	7400	5500	32306 BF
0,59	1,30	67,5	51,0	64,0	38,5	37,0	3,0	5,5	75,2	95,6	0,61	0,99	0,54	7300	5400	32306 C
0,55	1,21	66,0	59,0	64,5	39,0	37,5	3,0	5,5	86,6	96,2	0,31	1,90	1,04	7700	5700	32306 F
0,20	0,43	55,0	50,0	53,0	38,0	36,0	3,0	4,0	42,9	52,3	0,45	1,32	0,72	8500	6300	320/32 XF
0,20	0,43	55,0	50,0	53,0	38,0	36,0	3,0	4,0	42,9	52,3	0,45	1,32	0,72	8500	6300	320/32 XR
0,39	0,86	62,0	55,0	60,0	38,0	36,0	5,0	5,5	78,0	95,1	0,34	1,73	0,95	8000	5900	332/32 F
0,22	0,48	58,0	53,5	56,0	40,0	39,0	4,0	4,0	40,4	52,7	0,44	1,35	0,74	8000	5900	32007 X 34/32007 XF
0,22	0,48	59,0	53,5	56,0	41,0	41,0	4,0	4,0	40,4	52,7	0,44	1,35	0,74	7900	5900	32007 XF
0,22	0,47	59,0	53,5	56,0	40,0	39,0	4,0	4,0	40,4	52,7	0,44	1,35	0,74	7900	5900	32007 XR
0,26	0,57	59,0	54,5	57,0	41,0	39,0	3,0	4,0	55,8	75,2	0,31	1,96	1,08	8100	6000	33007 F
0,32	0,70	67,0	62,0	64,5	44,0	42,5	3,0	3,0	61,4	69,0	0,37	1,60	0,88	7300	5400	30207 F
0,43	0,95	67,0	60,5	64,5	42,5	42,5	3,0	5,0	74,6	88,6	0,37	1,60	0,88	7300	5400	32207 F
0,55	1,21	68,0	60,5	66,0	42,0	41,0	5,0	6,0	95,1	116,6	0,35	1,70	0,93	7300	5400	33207 F
0,43	0,95	67,0	62,0	74,0	44,0	41,0	3,0	3,0	60,1	66,9	0,37	1,60	0,88	6700	5000	30207/80 F
0,52	1,14	74,0	69,0	70,5	45,0	44,5	3,0	4,5	83,6	87,3	0,31	1,90	1,04	6800	5000	30307 F
0,52	1,14	76,0	62,0	70,5	44,0	44,5	3,0	7,5	73,7	81,9	0,82	0,72	0,40	6100	4500	31307 F
0,73	1,61	74,0	66,0	70,5	44,0	44,5	3,0	7,5	106,6	120,0	0,31	1,90	1,04	6800	5000	32307 F
0,31	0,67	67,0	62,0	64,5	44,0	43,0	3,0	3,0	60,1	66,9	0,37	1,60	0,88	7100	5300	30207/37 F
1,04	2,29	82,5	66,0	80,5	50,0	46,0	3,0	8,0	128,6	156,0	0,34	1,74	0,95	6100	4500	323/38 F
0,27	0,59	65,0	60,0	63,0	46,0	44,0	4,0	4,5	54,9	76,0	0,38	1,58	0,87	7200	5300	32008 XF
0,33	0,73	65,0	60,5	63,0	46,0	44,0	2,5	4,0	65,8	92,6	0,28	2,12	1,17	7300	5400	33008 F
0,51	1,12	71,0	64,5	69,0	47,5	45,3	4,0	5,5	89,2	115,5	0,36	1,68	0,93	6800	5000	33108 F
0,41	0,90	74,0	69,0	72,5	49,0	47,5	3,0	3,5	71,7	80,7	0,37	1,60	0,88	6500	4800	30208 F
0,53	1,17	75,0	68,0	72,5	48,0	47,5	3,0	5,5	84,6	99,7	0,37	1,60	0,88	6500	4800	32208 F
0,72	1,58	76,0	66,5	72,5	47,0	47,5	5,0	7,0	113,3	146,0	0,35	1,67	0,92	6500	4800	33208 F
0,72	1,58	82,0	76,0	80,5	52,5	49,5	3,0	5,0	99,1	110,9	0,34	1,74	0,95	6000	4400	30308 F
0,72	1,58	86,0	70,0	84,0	50,5	47,0	3,0	8,0	91,2	103,7	0,83	0,73	0,40	5400	4000	31308 F
0,95	2,09	84,0	67,0	84,0	49,0	47,0	3,0	9,0	116,6	149,7	0,55	1,10	0,60	5800	4300	32308 C
1,00	2,20	82,0	72,5	80,5	50,0	49,5	3,0	8,0	128,6	156,0	0,34	1,74	0,95	6000	4400	32308 F
1,03	2,26	85,0	67,0	84,0	50,0	47,0	4,0	8,0	116,6	149,5	0,55	1,10	0,60	5800	4300	32308 BF

01.1

METRIC SERIES SERIES MÉTRICAS

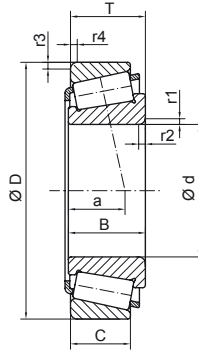
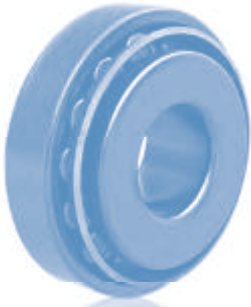

DIMENSIONS / DIMENSIONES													ISO REF / REF ISO	REFERENCES / REFERENCIAS
d		D		T		B		C		r1/r2 min	r3/r4 min	a		
mm	inch	mm	inch	mm	inch	mm	inch	mm	inch	mm	mm	mm		
45,000	1,772	75,000	2,953	20,000	0,787	20,000	0,787	15,500	0,610	1,0	1,0	16,0	T3CC045	32009 XF
		75,000	2,953	24,000	0,945	24,000	0,945	19,000	0,748	1,0	1,0	16,5	T2CE045	33009 F
		80,000	3,150	26,000	1,024	26,000	1,024	20,500	0,807	1,5	1,5	19,0	T3CE045	33109 F
		85,000	3,346	20,750	0,817	19,000	0,748	16,000	0,630	1,5	1,5	18,2	T3DB045	32029 F
		85,000	3,346	24,750	0,974	23,000	0,906	19,000	0,748	1,5	1,5	20,2	T3DC045	32209 F
		85,000	3,346	32,000	1,260	32,000	1,260	25,000	0,984	1,5	1,5	22,0	T3DE045	33209 F
		90,000	3,543	24,750	0,974	23,000	0,906	19,000	0,748	1,5	1,5	21,1	---	32210/45
		100,000	3,937	27,250	1,073	25,000	0,984	22,000	0,866	2,0	1,5	21,3	TCFB045	30309 F
		100,000	3,937	27,250	1,073	25,000	0,984	18,000	0,709	2,0	1,5	31,0	T7FB045	31309 F
		100,000	3,937	38,250	1,506	36,000	1,417	30,000	1,181	2,0	1,5	30,0	T2FD045	32309 BF
100,000	3,937	38,250	1,506	36,000	1,417	30,000	1,181	2,0	1,5	24,7	T5FD045	32309 F		
50,000	1,969	80,000	3,150	20,000	0,787	20,000	0,787	15,500	0,610	1,0	1,0	17,9	T3CC050	32010 XF
		80,000	3,150	20,000	0,787	20,000	0,787	15,500	0,610	3,8	1,0	17,8	---	32010 XR
		80,000	3,150	24,000	0,945	24,000	0,945	19,000	0,748	1,0	1,0	17,0	T2CE050	33010 F
		85,000	3,346	26,000	1,024	26,000	1,024	20,000	0,787	1,5	1,5	20,0	T3CE050	33110 F
		90,000	3,543	21,750	0,856	20,000	0,787	17,000	0,669	1,5	1,5	19,6	T3DB050	30210 F
		90,000	3,543	24,750	0,974	23,000	0,906	19,000	0,748	1,5	1,5	21,1	T3DC050	32210 F
		90,000	3,543	32,000	1,260	32,000	1,260	24,500	0,965	1,5	1,5	23,5	T3DE050	33210 F
		110,000	4,331	29,250	1,152	27,000	1,063	23,000	0,906	2,5	2,0	23,1	T2FB050	30310 F
		110,000	4,331	29,250	1,152	27,000	1,063	19,000	0,748	2,5	2,0	34,9	T7FB050	31310 F
		110,000	4,331	42,250	1,663	40,000	1,575	33,000	1,299	2,5	2,0	27,9	T2FD050	32310 F
55,000	2,165	80,000	3,150	17,000	0,669	17,000	0,669	14,000	0,551	1,0	1,0	14,5	T2BC055	32911 F
		90,000	3,543	23,000	0,906	23,000	0,906	17,500	0,689	1,5	1,5	19,5	T3CC055	32011 XF
		90,000	3,543	27,000	1,063	27,000	1,063	21,000	0,827	1,5	1,5	19,3	T2CE055	33011 F
		95,000	3,740	30,000	1,181	30,000	1,181	23,000	0,906	1,5	1,5	22,4	T3CE055	33111 F
		100,000	3,937	22,750	0,896	21,000	0,827	18,000	0,709	2,0	1,5	20,7	T3DB055	30211 F
		100,000	3,937	26,750	1,053	25,000	0,984	21,000	0,827	2,0	1,5	22,7	T3DC055	32211 F
		100,000	3,937	35,000	1,378	35,000	1,378	27,000	1,063	2,0	1,5	25,0	T3DE055	33211 F
		110,000	4,331	42,250	1,663	40,000	1,575	33,000	1,299	2,5	2,0	27,9	---	32310/55
		120,000	4,724	31,500	1,240	29,000	1,142	25,000	0,984	2,5	2,0	24,0	T2FB055	30311 F
		120,000	4,724	31,500	1,240	29,000	1,142	21,000	0,827	2,5	2,0	37,0	T7FB055	31311 F
		120,000	4,724	45,500	1,791	43,000	1,693	35,000	1,378	2,5	2,0	29,9	T2FD055	32311 F

Assembly / Montaje

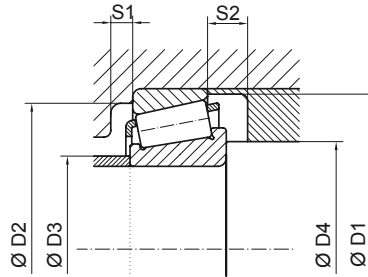

WEIGHT / PESO		ASSEMBLY / MONTAJE							LOAD / CARGA		LOAD FACTORS / FACTORES DE CARGA			SPEED / VELOCIDAD		REFERENCES / REFERENCIAS
		D1 min	D2 min	D2 max	D3 max	D4 min	S1	S2	Dynamic / Dinámica	Static / Estática	Dynamics / Dinámicos	Statics / Estáticos	Yo	Oil / Aceite	Grease / Grasa	
kg	lb	mm	mm	mm	mm	mm	mm	mm	C	Co	e	Y	Yo	na	ng	
0,34	0,75	72,0	66,5	70,0	51,0	49,0	4,0	4,5	67,0	93,9	0,39	1,52	0,84	6400	4700	32009 XF
0,42	0,92	71,0	66,5	70,0	51,0	49,0	4,0	5,0	75,8	109,0	0,29	2,04	1,12	6500	4800	33009 F
0,56	1,23	77,0	69,0	74,0	52,0	51,0	4,0	5,5	95,0	128,6	0,38	1,56	0,86	6200	4600	33109 F
0,46	1,01	80,0	73,5	77,5	54,0	52,5	3,0	4,5	77,3	91,2	0,40	1,48	0,81	5900	4400	32029 F
0,58	1,28	80,0	73,0	77,5	53,5	52,5	3,0	5,5	91,2	112,7	0,40	1,48	0,81	5900	4400	32209 F
0,82	1,80	81,0	71,5	79,0	52,0	51,0	5,0	7,0	121,8	161,3	0,39	1,55	0,86	6000	4400	33209 F
0,56	1,23	85,5	77,5	82,5	58,0	51,0	3,0	5,5	93,4	116,3	0,42	1,43	0,78	5700	4200	32210/45
0,97	2,13	92,0	85,0	90,5	58,5	54,5	3,0	5,0	122,9	139,9	0,34	1,74	0,95	5400	4000	30309 F
0,95	2,09	95,0	78,0	94,0	56,0	52,0	4,0	9,0	103,9	118,0	0,82	0,72	0,40	4800	3600	31309 F
1,45	3,19	94,0	75,0	94,0	55,0	52,0	5,0	8,0	146,7	183,8	0,55	1,10	0,60	5200	3900	32309 BF
1,35	2,97	93,0	81,5	90,5	57,0	54,5	3,0	8,0	155,3	190,9	0,34	1,74	0,95	5400	4000	32309 F
0,37	0,81	77,0	71,0	74,0	56,5	56,0	4,0	4,5	64,0	90,9	0,42	1,41	0,78	5900	4400	32010 XF
0,36	0,79	77,0	71,0	74,0	56,0	54,0	4,0	4,5	64,0	90,9	0,42	1,41	0,78	5900	4400	32010 XR
0,46	1,01	76,0	71,0	75,0	56,0	54,0	4,0	5,0	79,3	120,9	0,32	1,89	1,04	6000	4400	33010 F
0,60	1,32	82,0	73,5	78,0	57,5	57,0	4,0	6,0	94,0	134,5	0,41	1,46	0,80	5700	4200	33110 F
0,53	1,17	85,0	78,5	82,5	58,0	57,5	3,0	4,5	84,2	101,7	0,42	1,43	0,79	5500	4100	30210 F
0,61	1,34	85,0	77,5	82,5	57,5	57,5	3,0	5,5	93,4	116,3	0,42	1,43	0,78	5500	4100	32210 F
0,83	1,83	87,0	76,0	82,5	56,5	57,5	5,0	7,5	125,3	174,7	0,41	1,45	0,79	5500	4100	33210 F
1,25	2,75	102,0	94,0	99,0	65,5	61,0	3,0	6,0	142,7	163,3	0,34	1,74	0,95	4900	3600	30310 F
1,20	2,64	104,0	86,0	99,0	62,0	61,0	4,0	10,0	125,5	145,0	0,82	0,72	0,40	4400	3300	31310 F
1,80	3,96	102,0	89,5	99,0	62,0	61,0	3,0	9,0	188,7	235,7	0,34	1,74	0,95	4900	3600	32310 F
0,28	0,61	76,0	72,5	75,5	61,0	59,0	3,0	3,0	49,5	82,6	0,31	1,94	1,07	5800	4300	32911 F
0,55	1,21	86,0	79,5	82,5	63,5	62,5	4,0	5,5	90,3	131,8	0,41	1,48	0,81	5300	3900	32011 XF
0,67	1,47	86,0	80,0	82,0	63,5	62,0	5,0	6,0	102,0	156,8	0,31	1,92	1,06	5400	4000	33011 F
0,88	1,94	91,0	82,0	94,3	62,4	60,5	5,0	7,0	120,8	171,0	0,37	1,60	0,88	5200	3900	33111 F
0,69	1,51	94,0	87,5	90,5	64,0	64,5	4,0	4,5	103,9	125,1	0,40	1,48	0,81	5000	3700	30211 F
0,83	1,83	95,0	86,0	90,5	63,0	64,5	4,0	5,5	119,4	149,6	0,40	1,48	0,81	5000	3700	32211 F
1,20	2,64	96,0	84,5	91,0	62,5	63,5	6,0	8,0	150,9	207,3	0,40	1,50	0,83	5000	3700	33211 F
1,63	3,59	102,5	89,5	99,0	62,0	65,0	3,0	9,0	188,7	235,7	0,34	1,74	0,95	4700	3500	32310/55
1,55	3,41	111,0	102,5	112,0	71,0	64,0	4,0	6,5	163,0	187,4	0,34	1,74	0,95	4500	3300	30311 F
1,55	3,41	113,0	93,0	112,0	68,0	64,0	4,0	10,5	137,2	157,2	0,82	0,72	0,40	4000	3000	31311 F
2,30	5,06	111,0	97,5	112,5	69,0	63,5	4,0	10,5	224,0	285,4	0,34	1,74	0,96	4500	3300	32311 F

01.1

METRIC SERIES SERIES MÉTRICAS

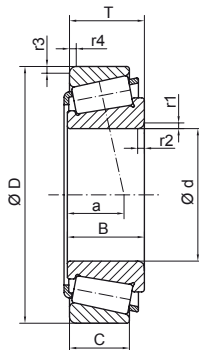

DIMENSIONS / DIMENSIONES													ISO REF / REF ISO	REFERENCES / REFERENCIAS
d		D		T		B		C		r1/r2 min	r3/r4 min	a		
mm	inch	mm	inch	mm	inch	mm	inch	mm	inch	mm	mm	mm		
57,500	2,264	90,000	3,543	23,000	0,906	23,000	0,906	17,500	0,689	1,5	1,5	19,5	---	32011 X 575/32011 XF
60,000	2,362	95,000	3,740	23,000	0,906	23,000	0,906	17,500	0,689	1,5	1,5	20,8	T4CC060	32012 XF
		95,000	3,740	27,000	1,063	27,000	1,063	21,000	0,827	1,5	1,5	20,0	T2CE060	33012 F
		100,000	3,937	30,000	1,181	30,000	1,181	23,000	0,906	1,5	1,5	23,3	T3CE060	33012 F
		110,000	4,331	23,750	0,935	22,000	0,866	19,000	0,748	2,0	1,5	22,0	T3EB060	30212 F
		110,000	4,331	29,750	1,171	28,000	1,102	24,000	0,945	2,0	1,5	24,5	T3EC060	32212 F
		110,000	4,331	38,000	1,496	38,000	1,496	29,000	1,142	2,0	1,5	27,3	T3EE060	33212 F
		130,000	5,118	33,500	1,319	31,000	1,220	26,000	1,024	3,0	2,5	26,3	T2FB060	30312 F
		130,000	5,118	33,500	1,319	31,000	1,220	22,000	0,866	3,0	2,5	39,0	T7FB060	31312 F
		130,000	5,118	48,500	1,909	46,000	1,811	37,000	1,457	3,0	2,5	38,5	T5FD060	32312 BF
		130,000	5,118	48,500	1,909	46,000	1,811	37,000	1,457	3,0	2,5	31,8	T2FD060	32312 F
65,000	2,559	100,000	3,937	23,000	0,906	23,000	0,906	17,500	0,689	1,5	1,5	22,3	T4CC065	32013 XF
		100,000	3,937	27,000	1,063	27,000	1,063	21,000	0,827	1,5	1,5	21,1	T2CE065	33013 F
		110,000	4,331	34,000	1,339	34,000	1,339	26,500	1,043	1,5	1,5	25,9	T3DE065	33113 F
		120,000	4,724	24,750	0,974	23,000	0,906	20,000	0,787	2,0	1,5	23,6	T3EB065	30213 F
		120,000	4,724	32,750	1,289	31,000	1,220	27,000	1,063	2,0	1,5	27,1	T3EC065	32213 F
		120,000	4,724	41,000	1,614	41,000	1,614	32,000	1,260	2,0	1,5	29,6	T3EE065	33213 F
		140,000	5,512	36,000	1,417	33,000	1,299	28,000	1,102	3,0	2,5	28,0	T2GB065	30313 F
		140,000	5,512	36,000	1,417	33,000	1,299	23,000	0,906	3,0	2,5	43,9	T7GB065	31313 F
		140,000	5,512	51,000	2,008	48,000	1,890	39,000	1,535	3,0	2,5	42,0	T5GD065	32313 BF
		140,000	5,512	51,000	2,008	48,000	1,890	39,000	1,535	3,0	2,5	34,3	T2GD065	32313 F
70,000	2,756	110,000	4,331	25,000	0,984	25,000	0,984	19,000	0,748	1,5	1,5	23,7	T4CC070	32014 XF
		110,000	4,331	31,000	1,220	31,000	1,220	25,500	1,004	1,5	1,5	23,0	T2CE070	33014 F
		120,000	4,724	37,000	1,457	37,000	1,457	29,000	1,142	2,0	1,5	27,7	T3DE070	33114 F
		125,000	4,921	26,250	1,033	24,000	0,945	21,000	0,827	2,0	1,5	25,6	T3EB070	30214 F
		125,000	4,921	33,250	1,309	31,000	1,220	27,000	1,063	2,0	1,5	28,9	T3EC070	32214 F
		125,000	4,921	41,000	1,614	41,000	1,614	32,000	1,260	2,0	1,5	31,8	T3EE070	33214 F
		150,000	5,906	38,000	1,496	35,000	1,378	30,000	1,181	3,0	2,5	29,9	T2GB070	30314 F
		150,000	5,906	38,000	1,496	35,000	1,378	25,000	0,984	3,0	2,5	45,0	T7GB070	31314 F
		150,000	5,906	54,000	2,126	51,000	2,008	42,000	1,654	3,0	2,5	44,0	T5GD070	32314 BF
		150,000	5,906	54,000	2,126	51,000	2,008	42,000	1,654	3,0	2,5	36,5	T2GD070	32314 F
75,000	2,953	115,000	4,528	25,000	0,984	25,000	0,984	19,000	0,748	1,5	1,5	25,1	T4CC075	32015 XF

Assembly / Montaje

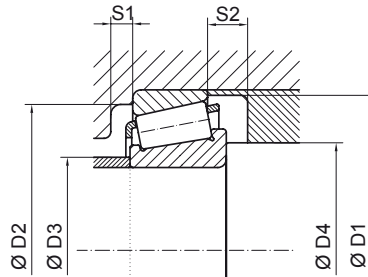

WEIGHT / PESO		ASSEMBLY / MONTAJE							LOAD / CARGA		LOAD FACTORS / FACTORES DE CARGA			SPEED / VELOCIDAD		REFERENCES / REFERENCIAS
		D1 min	D2 min	D2 max	D3 max	D4 min	S1	S2	Dynamic / Dinámica	Static / Estática	Dynamics / Dinámicos	Statics / Estáticos	Yo	Oil / Aceite	Grease / Grasa	
kg	lb	mm	mm	mm	mm	mm	mm	mm	C	Co	e	Y	Yo	na	ng	
0,51	1,13	87,0	79,5	82,5	63,5	65,0	4,0	5,5	224,0	285,4	0,34	1,74	0,96	5200	3900	32011 X 575/32011 XF
0,59	1,30	91,0	84,0	87,5	67,0	67,5	4,0	5,5	90,2	131,5	0,43	1,39	0,77	5000	3700	32012 XF
0,71	1,56	90,0	83,5	89,0	67,0	66,0	5,0	6,0	109,9	168,9	0,33	1,82	1,01	5000	3700	33012 F
0,94	2,07	96,0	86,5	94,0	67,5	65,5	5,0	7,0	128,0	188,4	0,40	1,51	0,83	4800	3600	33112 F
0,87	1,91	103,0	95,0	100,5	70,0	69,5	4,0	4,5	113,8	136,1	0,40	1,48	0,81	4500	3300	30212 F
1,15	2,53	104,0	93,5	100,5	68,5	69,5	4,0	5,5	141,9	181,0	0,40	1,48	0,81	4500	3300	32212 F
1,60	3,52	105,0	92,0	101,5	68,5	68,5	6,0	9,0	182,8	258,9	0,40	1,48	0,82	4500	3300	33212 F
1,95	4,29	120,0	111,0	121,0	78,0	70,0	4,0	7,5	191,7	223,6	0,34	1,74	0,95	4100	3000	30312 F
1,90	4,18	123,0	101,5	121,0	73,0	70,0	5,0	11,5	168,0	197,8	0,83	0,73	0,40	3700	2700	31312 F
3,05	6,71	122,0	97,5	121,0	71,0	70,0	6,0	11,5	242,0	340,5	0,55	1,10	0,60	3900	2900	32312 BF
2,85	6,27	120,0	106,0	121,0	74,7	72,3	4,0	11,5	254,2	324,2	0,34	1,74	0,96	4100	3000	32312 F
0,63	1,39	97,0	89,0	94,0	72,5	70,5	4,0	5,5	88,0	135,8	0,46	1,31	0,72	4600	3400	32013 XF
0,77	1,69	96,0	88,5	93,0	72,0	72,0	5,0	6,0	108,5	177,2	0,35	1,72	0,95	4700	3500	33013 F
1,32	2,90	106,0	95,0	104,0	75,0	70,3	6,0	7,5	150,7	232,2	0,39	1,55	0,85	4400	3300	33113 F
1,10	2,43	113,0	105,0	110,5	78,0	74,5	4,0	4,5	133,3	160,4	0,40	1,48	0,81	4200	3100	30213 F
1,50	3,30	115,0	102,5	110,5	76,0	74,5	4,0	5,5	169,8	219,5	0,40	1,48	0,81	4200	3100	32213 F
1,91	4,20	115,0	101,0	110,5	74,5	74,5	7,0	9,0	211,4	293,8	0,39	1,53	0,84	4200	3100	33213 F
2,30	5,06	130,0	120,0	131,0	83,0	75,0	4,0	8,0	219,9	259,1	0,34	1,74	0,95	3800	2800	30313 F
2,35	5,17	132,0	109,5	126,5	79,0	77,5	5,0	13,0	193,1	229,3	0,82	0,72	0,40	3400	2500	31313 F
3,72	8,17	133,0	115,0	131,0	77,0	75,0	6,0	12,0	274,2	386,6	0,55	1,10	0,60	3900	2900	32313 BF
3,45	7,59	130,0	115,0	131,0	80,0	75,0	4,0	12,0	287,2	368,0	0,35	1,74	0,96	3800	2800	32313 F
0,84	1,85	105,0	97,0	102,5	78,0	77,5	5,0	6,0	113,5	172,1	0,43	1,38	0,76	4300	3200	32014 XF
1,12	2,46	105,0	98,0	104,0	78,0	76,0	5,0	5,5	145,6	228,8	0,28	2,10	1,16	4400	3300	33014 F
1,70	3,74	115,0	103,0	114,3	79,3	76,8	5,0	8,0	187,4	277,7	0,38	1,58	0,87	4100	3000	33114 F
1,22	2,69	118,0	109,0	114,5	81,5	79,5	4,0	5,0	145,6	181,5	0,42	1,42	0,78	3900	2900	30214 F
1,60	3,52	119,0	107,0	114,5	80,0	79,5	4,0	6,0	177,4	234,4	0,42	1,43	0,78	3900	2900	32214 F
2,17	4,77	120,0	105,5	116,5	79,5	78,5	7,0	9,0	218,2	311,5	0,41	1,47	0,81	3900	2900	33214 F
2,90	6,38	140,0	128,5	140,5	90,5	80,0	4,0	8,0	244,4	294,6	0,35	1,74	0,96	3500	2600	30314 F
2,95	6,49	141,0	116,5	141,0	84,0	80,0	5,0	13,0	212,3	252,4	0,83	0,73	0,40	3200	2400	31314 F
4,51	9,92	143,0	113,5	139,0	83,0	81,0	6,0	12,0	310,8	441,4	0,55	1,10	0,60	3400	2500	32314 BF
4,30	9,46	140,0	123,0	141,0	86,0	80,0	4,0	12,0	323,1	417,3	0,35	1,74	0,96	3500	2600	32314 F
0,90	1,98	110,0	101,5	107,5	82,5	82,5	5,0	6,0	118,5	185,7	0,46	1,30	0,72	4000	3000	32015 XF

01.1

METRIC SERIES SERIES MÉTRICAS

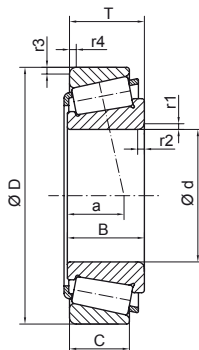
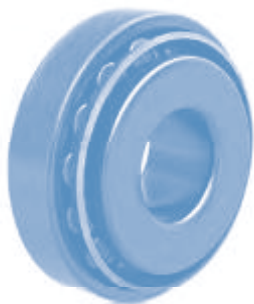

DIMENSIONS / DIMENSIONES													ISO REF / REF ISO	REFERENCES / REFERENCIAS
d		D		T		B		C		r1/r2 min	r3/r4 min	a		
mm	inch	mm	inch	mm	inch	mm	inch	mm	inch	mm	mm	mm		
75,000	2,953	115,000	4,528	31,000	1,220	31,000	1,220	25,500	1,004	1,5	1,5	23,3	T2CE075	33015 F
		125,000	4,921	37,000	1,457	37,000	1,457	29,000	1,142	2,0	1,5	28,9	T3DE075	33115 F
		130,000	5,118	27,250	1,073	25,000	0,984	22,000	0,866	2,0	1,5	27,2	T4DB075	30215 F
		130,000	5,118	33,250	1,309	31,000	1,220	27,000	1,063	2,0	1,5	29,8	T4DC075	32215 F
		130,000	5,118	41,000	1,614	41,000	1,614	31,000	1,220	2,0	1,5	32,6	T3EE075	33215 F
		130,000	5,118	47,250	1,860	45,000	1,772	27,000	1,063	ESP	1,5	29,8	---	XUA 32215/Y32215
		160,000	6,299	40,000	1,575	37,000	1,457	31,000	1,220	3,0	2,5	31,0	T2GB075	30315 F
		160,000	6,299	40,000	1,575	37,000	1,457	26,000	1,024	3,0	2,5	48,0	T7GB075	31315 F
		160,000	6,299	58,000	2,283	55,000	2,165	45,000	1,772	3,0	2,5	39,0	T2GD075	32315 F
80,000	3,150	125,000	4,921	29,000	1,142	29,000	1,142	22,000	0,866	1,5	1,5	26,9	T3CC080	32016 XF
		125,000	4,921	36,000	1,417	36,000	1,417	29,500	1,161	1,5	1,5	26,0	TCCE080	33016 F
		130,000	5,118	37,000	1,457	37,000	1,457	29,000	1,142	2,0	1,5	30,9	T3DE080	33116 F
		140,000	5,512	28,250	1,112	26,000	1,024	22,000	0,866	2,5	2,0	28,0	T3EB080	30216 F
		140,000	5,512	35,250	1,388	33,000	1,299	28,000	1,102	2,5	2,0	30,6	T3EC080	32216 F
		140,000	5,512	35,250	1,388	33,000	1,299	28,000	1,102	ESP	2,0	30,6	T3EC080	32216 F 573810
		140,000	5,512	46,000	1,811	46,000	1,811	35,000	1,378	2,5	2,0	34,9	T3EE080	33216 F
		170,000	6,693	42,500	1,673	39,000	1,535	33,000	1,299	3,0	2,5	34,0	T2GB080	30316 F
		170,000	6,693	61,500	2,421	58,000	2,283	48,000	1,890	3,0	2,5	42,0	T2GD080	32316 F
85,000	3,346	130,000	5,118	29,000	1,142	29,000	1,142	22,000	0,866	1,5	1,5	28,0	T4CC085	32017 XF
		130,000	5,118	36,000	1,417	36,000	1,417	29,500	1,161	1,5	1,5	26,7	T2CE085	33017 F
		140,000	5,512	41,000	1,614	41,000	1,614	32,000	1,260	2,5	2,0	32,9	T3DE085	33117 F
		150,000	5,906	30,500	1,201	28,000	1,102	24,000	0,945	2,5	2,0	29,9	T3EB085	30217 F
		150,000	5,906	38,500	1,516	36,000	1,417	30,000	1,181	2,5	2,0	33,2	T3EC085	32217 F
		150,000	5,906	49,000	1,929	49,000	1,929	37,000	1,457	2,5	2,0	37,0	T3EE085	33217 F
		180,000	7,087	63,500	2,500	60,000	2,362	49,000	1,929	4,0	3,0	43,0	T2GD085	32317 F
90,000	3,543	140,000	5,512	32,000	1,260	32,000	1,260	24,000	0,945	2,0	1,5	30,0	T3CC090	32018 XF
		140,000	5,512	39,000	1,535	39,000	1,535	32,500	1,280	2,0	1,5	28,0	T2CE090	33018 F
		150,000	5,906	45,000	1,772	45,000	1,772	35,000	1,378	2,5	2,0	34,8	T3DE090	33118 F
		160,000	6,299	32,500	1,280	30,000	1,181	26,000	1,024	2,5	2,0	31,0	T3FB090	30218 F
		160,000	6,299	42,500	1,673	40,000	1,575	34,000	1,339	2,5	2,0	36,0	T3FC090	32218 F
		160,000	6,299	55,000	2,165	55,000	2,165	42,000	1,654	2,5	2,0	41,0	T3FE090	33218 F
		190,000	7,480	46,500	1,831	43,000	1,693	30,000	1,181	4,0	3,0	56,0	T7GB090	31318 F

Assembly / Montaje

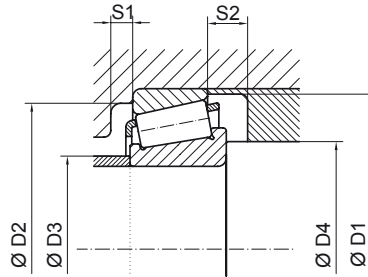

WEIGHT / PESO		ASSEMBLY / MONTAJE							LOAD / CARGA		LOAD FACTORS / FACTORES DE CARGA			SPEED / VELOCIDAD		REFERENCES / REFERENCIAS
		D1 min	D2 min	D2 max	D3 max	D4 min	S1	S2	Dynamic / Dinámica	Static / Estática	Dynamics / Dinámicos	Statics / Estáticos	Yo	Oil / Aceite	Grease / Grasa	
kg	lb	mm	mm	mm	mm	mm	mm	mm	C	Co	e	Y	Yo	na	ng	
1,18	2,60	110,0	102,5	108,0	84,0	82,0	5,0	5,5	149,2	252,4	0,30	2,01	1,11	4100	3000	33015 F
1,75	3,85	120,0	107,5	116,0	84,0	82,5	6,0	8,0	191,9	291,6	0,39	1,51	0,83	3800	2800	33115 F
1,35	2,97	124,0	113,5	119,5	86,0	84,5	4,0	5,0	153,3	195,3	0,43	1,38	0,76	3700	2700	30215 F
1,70	3,74	124,0	112,0	119,5	85,0	84,5	4,0	6,0	190,4	258,7	0,43	1,38	0,76	3700	2700	32215 F
2,27	4,99	125,0	110,0	124,0	83,0	82,0	7,0	10,0	218,2	313,8	0,43	1,40	0,77	3700	2700	33215 F
1,89	4,16	125,5	112,5	121,0	86,0	82,5	4,0	20,0	185,9	250,7	0,43	1,38	0,76	3700	2700	XUA 32215/Y32215
3,45	7,59	149,0	137,5	151,0	95,0	85,0	4,0	9,0	275,1	328,1	0,34	1,74	0,95	3300	2400	30315 F
3,50	7,70	151,0	125,5	148,5	91,5	86,3	6,0	14,0	241,3	290,3	0,82	0,73	0,40	3000	2200	31315 F
5,20	11,44	149,0	131,0	151,0	91,0	85,0	4,0	13,0	363,4	488,1	0,35	1,74	0,96	3300	2400	32315 F
1,30	2,86	120,0	110,5	117,5	89,5	87,5	6,0	6,5	151,8	240,8	0,42	1,41	0,78	3700	2700	32016 XF
1,65	3,63	119,0	111,0	119,0	90,0	86,0	6,0	6,5	187,9	316,0	0,28	2,15	1,19	3800	2800	33016 F
1,82	4,00	126,0	112,5	119,5	89,5	89,5	6,0	8,0	203,1	325,8	0,41	1,44	0,79	3600	2700	33116 F
1,60	3,52	132,0	122,5	132,0	91,0	89,0	4,0	6,0	172,6	215,7	0,42	1,42	0,78	3500	2600	30216 F
2,05	4,51	134,0	120,5	128,0	91,0	91,0	4,0	7,0	208,2	275,4	0,42	1,43	0,78	3500	2600	32216 F
2,05	4,51	134,0	120,5	128,0	91,0	91,0	4,0	7,0	208,2	275,4	0,42	1,43	0,78	3500	2600	32216 F 573810
2,86	6,29	135,0	118,0	128,0	89,5	91,0	7,0	11,0	271,8	406,1	0,42	1,41	0,77	3500	2600	33216 F
4,34	9,55	159,0	146,5	161,0	102,0	90,0	4,0	9,5	310,6	375,8	0,35	1,74	0,96	3100	2300	30316 F
6,15	13,53	159,0	139,5	161,0	89,0	90,0	4,0	13,5	408,2	544,8	0,34	1,74	0,95	3100	2300	32316 F
1,35	2,97	125,0	115,0	124,0	94,0	90,5	6,0	7,0	155,2	248,7	0,44	1,36	0,75	3500	2600	32017 XF
1,75	3,85	125,0	116,0	124,0	94,0	90,5	6,0	6,5	194,6	332,9	0,29	2,06	1,13	3600	2700	33017 F
2,50	5,50	135,0	120,5	132,0	94,5	97,5	7,0	9,0	236,5	371,3	0,41	1,48	0,81	3400	2500	33117 F
2,05	4,51	141,0	130,0	142,0	98,0	93,5	5,0	6,5	199,1	254,5	0,42	1,43	0,79	3200	2400	30217 F
2,60	5,72	142,0	128,0	138,0	96,5	96,0	5,0	8,5	238,7	320,0	0,42	1,43	0,79	3200	2400	32217 F
3,70	8,14	144,0	126,0	142,0	95,0	94,0	7,0	12,0	319,4	479,4	0,42	1,43	0,79	3200	2400	33217 F
6,85	15,07	167,0	147,5	169,0	103,0	98,0	5,0	14,5	429,1	582,2	0,34	1,74	0,95	2900	2100	32317 F
1,75	3,85	134,0	123,0	129,5	100,0	99,5	6,0	8,0	187,1	302,4	0,42	1,41	0,78	3300	2400	32018 XF
2,25	4,95	135,0	125,5	134,0	100,0	97,0	7,0	6,5	240,2	397,7	0,27	2,23	1,23	3400	2500	33018 F
3,05	6,71	144,0	128,5	138,0	100,0	101,0	7,0	10,0	272,8	427,6	0,39	1,51	0,83	3200	2400	33118 F
2,55	5,61	150,0	138,0	152,0	103,0	99,0	5,0	6,5	222,1	284,9	0,42	1,42	0,78	3000	2200	30218 F
3,35	7,37	152,0	136,0	152,0	102,0	99,0	5,0	8,5	278,3	380,4	0,42	1,43	0,78	3000	2200	32218 F
4,76	10,47	154,0	133,0	152,0	100,0	99,0	8,0	13,0	373,4	572,0	0,42	1,42	0,78	3000	2200	33218 F
5,50	12,10	179,0	148,5	177,0	110,0	103,0	5,0	16,5	308,3	372,2	0,83	0,73	0,40	2500	1900	31318 F



01.1

METRIC SERIES SERIES MÉTRICAS

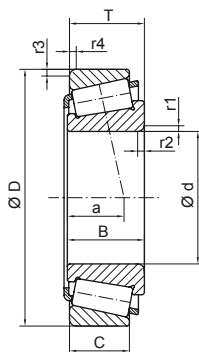
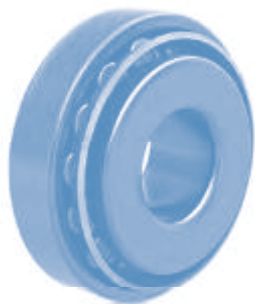

DIMENSIONS / DIMENSIONES													ISO REF / REF ISO	REFERENCES / REFERENCIAS
d		D		T		B		C		r1/r2 min	r3/r4 min	a		
mm	inch	mm	inch	mm	inch	mm	inch	mm	inch	mm	mm	mm		
95,000	3,740	145,000	5,709	32,000	1,260	32,000	1,260	24,000	0,945	2,0	1,5	31,1	T4CC095	32019 XF
		145,000	5,709	39,000	1,535	39,000	1,535	32,500	1,280	2,0	1,5	28,3	T2CE095	33019 F
		160,000	6,299	49,000	1,929	49,000	1,929	38,000	1,496	2,5	2,0	37,0	T3EE095	33119 F
		170,000	6,693	34,500	1,358	32,000	1,260	27,000	1,063	3,0	2,5	33,0	T3FB095	30219 F
		170,000	6,693	45,500	1,791	43,000	1,693	37,000	1,457	3,0	2,5	38,6	T3FC095	32219 F
100,000	3,937	150,000	5,906	32,000	1,260	32,000	1,260	24,000	0,945	2,0	1,5	32,5	T4CC100	32020 XF
		150,000	5,906	39,000	1,535	39,000	1,535	32,500	1,280	2,0	1,5	29,0	T2CE100	33020 F
		150,000	5,906	39,000	1,535	39,000	1,535	32,500	1,280	ESP	1,5	29,0	T2CE100	33020 F 561694
		165,000	6,496	52,000	2,047	52,000	2,047	40,000	1,575	2,5	2,0	40,0	T3EE100	33120 F
		180,000	7,087	37,000	1,457	34,000	1,339	29,000	1,142	3,0	2,5	35,9	T3FB100	30220 F
		180,000	7,087	49,000	1,929	46,000	1,811	39,000	1,535	3,0	2,5	41,0	T3FC100	32220 F
		180,000	7,087	49,000	1,929	46,000	1,811	39,000	1,535	8,0	2,5	41,0	---	32220 FR
		180,000	7,087	63,000	2,480	63,000	2,480	48,000	1,890	3,0	2,5	45,5	T3FE100	33220 F
105,000	4,134	160,000	6,299	35,000	1,378	35,000	1,378	26,000	1,024	2,5	1,0	34,0	T4DC105	32021 XF
		160,000	6,299	43,000	1,693	43,000	1,693	34,000	1,339	2,5	1,0	30,6	T2DE105	33021 F
		160,000	6,299	43,000	1,693	43,000	1,693	34,000	1,339	ESP	1,0	30,6	---	33021 F 0266488
		190,000	7,480	39,000	1,535	36,000	1,417	30,000	1,181	3,0	2,5	37,0	T3FB105	30221 F
		190,000	7,480	53,000	2,087	50,000	1,969	43,000	1,693	3,0	2,5	44,0	T3FC105	32221 F
110,000	4,331	170,000	6,693	38,000	1,496	38,000	1,496	29,000	1,142	2,5	2,0	36,5	T4DC110	32022 XF
		170,000	6,693	47,000	1,850	47,000	1,850	37,000	1,457	2,5	2,0	33,9	T2DE110	33022 F
		200,000	7,874	41,000	1,614	38,000	1,496	32,000	1,260	3,0	2,5	40,5	T3FB110	30222 F
		200,000	7,874	56,000	2,205	53,000	2,087	46,000	1,811	3,0	2,5	46,0	T3FC110	32222 F
120,000	4,724	165,000	6,496	29,000	1,142	29,000	1,142	23,000	0,906	1,5	1,5	29,1	T2CC120	32924 F
		180,000	7,087	38,000	1,496	38,000	1,496	29,000	1,142	2,5	2,0	39,0	T4DC120	32024 XF
		180,000	7,087	48,000	1,890	48,000	1,890	38,000	1,496	2,5	2,0	36,0	T2DE120	33024 F
		215,000	8,465	43,500	1,713	40,000	1,575	34,000	1,339	3,0	2,5	44,0	T4FB120	30224 F
130,000	5,118	230,000	9,055	43,750	1,722	40,000	1,575	34,000	1,339	4,0	3,0	45,0	T4FB130	30226 F

Assembly / Montaje

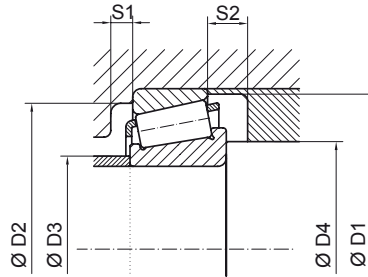

WEIGHT / PESO		ASSEMBLY / MONTAJE							LOAD / CARGA		LOAD FACTORS / FACTORES DE CARGA			SPEED / VELOCIDAD		REFERENCES / REFERENCIAS
		D1 min	D2 min	D2 max	D3 max	D4 min	S1	S2	Dynamic / Dinámica	Static / Estática	Dynamics / Dinámicos	Statics / Estáticos	Yo	Oil / Aceite	Grease / Grasa	
kg	lb	mm	mm	mm	mm	mm	mm	mm	C	Co	e	Y	Yo	na	ng	
1,80	3,96	140,0	128,0	134,5	105,0	104,5	6,0	8,0	184,7	303,0	0,44	1,35	0,74	3200	2400	32019 XF
2,35	5,17	139,0	129,5	136,7	104,0	103,3	7,0	6,5	226,9	374,0	0,28	2,16	1,19	3200	2400	33019 F
3,90	8,58	154,0	136,5	152,0	105,0	104,0	8,0	11,0	331,2	512,1	0,39	1,53	0,85	3000	2200	33119 F
3,00	6,60	159,0	146,5	161,0	110,0	105,0	5,0	7,5	257,8	337,6	0,42	1,43	0,79	2900	2100	30219 F
4,05	8,91	161,0	143,5	156,5	108,5	107,5	5,0	8,5	312,5	432,2	0,42	1,43	0,78	2900	2100	32219 F
1,90	4,18	144,0	132,5	144,0	109,5	107,0	6,0	8,0	188,3	314,1	0,46	1,31	0,72	3000	2200	32020 XF
2,44	5,37	143,0	133,5	144,0	108,0	107,0	7,0	6,5	242,8	413,7	0,29	2,09	1,15	3100	2300	33020 F
2,44	5,37	143,0	133,5	144,0	108,0	107,0	7,0	6,5	242,8	413,7	0,29	2,09	1,15	3100	2300	33020 F 561694
4,30	9,46	160,0	140,5	157,0	111,0	109,0	8,0	12,0	353,5	566,6	0,41	1,47	0,81	2900	2100	33120 F
3,65	8,03	168,0	154,5	171,0	117,0	110,0	5,0	8,0	279,1	366,1	0,42	1,42	0,78	2700	2000	30220 F
4,90	10,78	171,0	151,5	171,0	114,0	110,0	5,0	10,0	386,0	556,1	0,42	1,43	0,78	2700	2000	32220 F
4,90	10,78	171,0	151,5	171,0	114,0	110,0	5,0	10,0	386,0	556,1	0,42	1,43	0,78	2700	2000	32220 FR
6,73	14,80	173,0	149,0	171,0	113,5	110,0	10,0	15,0	412,4	645,6	0,40	1,48	0,82	2700	2000	33220 F
2,40	5,28	154,0	141,0	152,0	116,0	114,0	6,0	9,0	215,6	373,9	0,44	1,35	0,74	2900	2100	32021 XF
3,10	6,82	153,0	142,5	153,0	115,5	113,0	7,0	9,0	277,2	474,0	0,28	2,12	1,17	2900	2100	33021 F
3,10	6,82	153,0	142,5	153,0	115,5	125,0	7,0	9,0	277,2	474,0	0,28	2,12	1,17	2900	2100	33021 F 0266488
4,25	9,35	177,0	163,0	181,0	122,0	115,0	6,0	9,0	293,1	392,6	0,42	1,42	0,78	2600	1900	30221 F
5,90	12,97	180,0	158,5	181,0	120,0	115,0	6,0	10,0	387,3	555,5	0,43	1,43	0,79	2600	1900	32221 F
3,05	6,71	163,0	149,5	162,5	122,5	118,5	7,0	9,0	255,2	423,8	0,43	1,39	0,77	2700	2000	32022 XF
3,85	8,47	161,0	149,5	162,5	123,0	119,0	7,0	10,0	313,8	549,1	0,29	2,09	1,15	2800	2100	33022 F
5,10	11,22	187,0	171,5	189,0	129,0	120,0	6,0	9,0	331,8	448,6	0,42	1,42	0,78	2400	1800	30222 F
7,05	15,51	190,0	167,0	189,0	126,0	120,0	6,0	10,0	429,1	624,9	0,43	1,43	0,79	2400	1800	32222 F
1,77	3,89	160,0	152,0	159,5	128,0	125,5	9,0	6,0	197,0	349,2	0,35	1,72	0,95	2700	2000	32924 F
3,25	7,15	173,0	158,5	172,0	131,0	129,0	7,0	9,0	271,7	464,5	0,46	1,31	0,72	2500	1900	32024 XF
4,20	9,24	171,0	158,0	172,0	132,0	129,0	6,0	10,0	314,0	587,5	0,30	2,01	1,11	2600	1900	33024 F
6,25	13,75	202,0	185,0	204,5	142,0	131,0	9,0	9,5	366,9	497,2	0,44	1,38	0,76	2200	1600	30224 F
7,00	15,40	217,0	200,0	218,0	154,0	145,0	9,0	10,0	398,0	536,5	0,44	1,38	0,76	2000	1500	30226 F

01.2

INCH SERIES SERIES PULGADAS

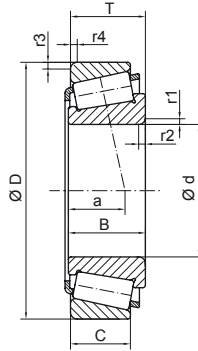

DIMENSIONS / DIMENSIONES												ISO REF / REF ISO	REFERENCES / REFERENCIAS
d		D		T		B		C		r1/r2 min	r3/r4 min		
mm	inch	mm	inch	mm	inch	mm	inch	mm	inch	mm	mm	mm	
15,875	0,625	42,862	1,688	14,288	0,563	14,288	0,563	9,525	0,375	1,6	1,6	13,0	11590/11520
15,987	0,629	46,975	1,849	21,000	0,827	21,000	0,827	16,000	0,630	1,0	2,0	6,0	HM 81649/HM 81610
16,993	0,669	47,000	1,850	14,382	0,566	14,381	0,566	11,112	0,438	1,5	1,3	10,3	05066/05185
17,462	0,688	39,878	1,570	13,843	0,545	14,605	0,575	10,668	0,420	1,3	1,3	8,5	LM 11749/LM 11710
19,050	0,750	39,992	1,575	12,014	0,473	11,153	0,439	9,525	0,375	1,0	1,3	10,5	A 6075/A 6157
		44,450	1,750	12,700	0,500	11,908	0,469	9,525	0,375	1,5	1,5	11,0	4 A/6
		45,237	1,781	15,494	0,610	16,637	0,655	12,065	0,475	1,2	1,2	9,9	LM 11949 RS/LM 11910
		45,237	1,781	15,494	0,610	16,637	0,655	12,065	0,475	1,2	1,2	9,9	LM 11949/LM 11910
		49,225	1,938	18,034	0,710	19,050	0,750	14,288	0,563	1,3	1,3	11,0	09067/09195
		49,225	1,938	19,845	0,781	21,539	0,848	14,288	0,563	1,5	1,3	11,0	09074/09195
		49,225	1,938	21,209	0,835	19,050	0,750	17,463	0,688	1,3	1,5	13,9	09067/09196
		49,225	1,938	23,020	0,906	21,539	0,848	17,463	0,688	1,5	1,5	13,9	09074/09196
		49,225	1,938	23,020	0,906	21,539	0,848	17,462	0,688	1,5	3,5	14,0	09074/09194
		53,975	2,125	22,225	0,875	21,839	0,860	15,875	0,625	1,5	2,3	16,5	21075/21212
20,625	0,812	49,225	1,938	19,845	0,781	21,539	0,848	14,288	0,563	1,5	1,3	11,0	09081/09195
		49,225	1,938	23,020	0,906	21,539	0,848	17,463	0,688	1,5	1,5	13,9	09081/09196
21,430	0,844	45,237	1,781	15,494	0,610	16,637	0,655	12,065	0,475	1,3	1,3	9,9	LM 12748/LM 12710
		50,005	1,969	17,026	0,670	17,788	0,700	13,470	0,530	1,3	1,3	10,6	M 12649 F/M 12610 F
		50,005	1,969	17,526	0,690	18,288	0,720	13,970	0,550	1,3	1,3	10,6	M 12649/M 12610
21,986	0,866	45,237	1,781	15,494	0,610	16,637	0,655	12,065	0,475	1,3	1,3	10,2	LM 12749/LM 12710
		45,974	1,810	15,494	0,610	16,637	0,655	12,065	0,475	1,3	1,3	10,2	LM 12749/LM 12711
22,225	0,875	50,800	2,000	15,011	0,591	14,260	0,561	12,700	0,500	1,3	1,5	12,1	07087/07210 X
		50,800	2,000	15,011	0,591	14,260	0,561	12,700	0,500	1,5	1,5	12,1	07087 X/07210 X
		51,994	2,047	15,011	0,591	14,260	0,561	12,700	0,500	1,3	1,3	12,1	07087/07204
		51,994	2,047	15,011	0,591	14,260	0,561	12,700	0,500	1,5	1,3	12,1	07087 X/07204
		52,388	2,063	19,368	0,763	20,168	0,794	14,288	0,563	1,5	1,5	11,7	1380/1328
23,812	0,938	56,896	2,240	19,368	0,763	19,837	0,781	15,875	0,625	0,8	1,5	12,5	1779/1729 X
25,000	0,984	51,994	2,047	15,011	0,591	14,260	0,561	12,700	0,500	1,5	1,3	12,1	07097/07204
25,400	1,000	50,005	1,969	13,495	0,531	14,260	0,561	9,525	0,375	1,5	1,0	10,2	07100/07196
		50,005	1,969	13,495	0,531	14,260	0,561	9,525	0,375	1,5	1,0	10,7	07100 S/07196
		50,292	1,980	14,224	0,560	14,732	0,580	10,668	0,420	1,3	1,3	10,9	L 44643 RS/L 44610
		50,292	1,980	14,224	0,560	14,732	0,580	10,668	0,420	1,3	1,3	10,9	L 44643/L 44610

Assembly / Montaje

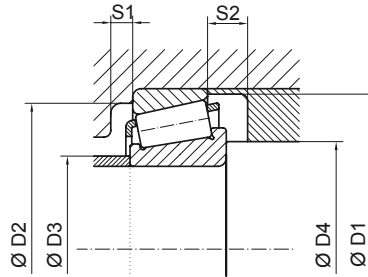

WEIGHT / PESO		ASSEMBLY / MONTAJE							LOAD / CARGA		LOAD FACTORS / FACTORES DE CARGA			SPEED / VELOCIDAD		REFERENCES / REFERENCIAS
		D1 min	D2 min	D2 max	D3 max	D4 min	S1	S2	Dynamic / Dinámica	Static / Estática	Dynamics / Dinámicos	Statics / Estáticos	Oil / Aceite	Grease / Grasa		
kg	lb	mm	mm	mm	mm	mm	mm	mm	kN	kN	e	Y	Yo	na	ng	
0,10	0,22	38,5	32,5	37,0	23,5	20,5	2,0	4,5	21,9	22,8	0,70	0,85	0,47	12300	9100	11590/11520
0,19	0,42	43,5	35,5	40,0	22,0	20,0	2,0	5,0	37,8	39,5	0,55	1,10	0,60	11900	8800	HM 81649/HM 81610
0,12	0,26	42,0	39,5	42,0	21,0	22,5	2,0	3,0	23,5	26,7	0,36	1,68	0,92	12200	9000	05066/05185
0,08	0,18	36,5	35,5	35,0	23,5	22,0	2,0	3,0	24,8	25,1	0,29	2,10	1,20	13700	10200	LM 11749/LM 11710
0,07	0,15	36,5	33,0	35,0	23,0	23,0	2,0	2,0	12,4	13,7	0,53	1,14	0,63	12800	9500	A 6075/A 6157
0,10	0,21	41,0	37,5	39,0	25,5	24,5	2,0	3,0	22,2	23,4	0,48	1,25	0,69	12000	8900	4 A/6
0,13	0,29	41,0	39,0	40,5	25,5	20,5	2,0	3,0	32,3	33,2	0,30	1,99	1,09	12200	9000	LM 11949 RS/LM 11910
0,12	0,27	41,0	39,0	40,5	26,0	23,5	2,5	3,0	32,2	33,2	0,30	1,99	1,09	12200	9000	LM 11949/LM 11910
0,17	0,37	44,0	41,5	44,0	26,5	24,0	3,0	3,5	40,6	40,9	0,26	2,25	1,24	11500	8500	09067/09195
0,18	0,39	44,0	41,5	44,0	26,5	24,5	3,0	5,5	40,6	40,9	0,26	2,25	1,24	11500	8500	09074/09195
0,19	0,42	44,0	40,5	43,5	26,5	24,0	3,0	3,5	40,6	40,9	0,26	2,25	1,24	11500	8500	09067/09196
0,20	0,44	44,0	40,5	43,5	26,5	24,5	3,0	5,5	40,6	40,9	0,26	2,25	1,24	11500	8500	09074/09196
0,20	0,44	44,0	40,5	37,5	26,5	24,5	3,0	5,5	40,6	40,9	0,26	2,25	1,24	11500	8500	09074/09194
0,25	0,54	50,5	40,5	46,0	26,5	24,5	2,5	6,0	47,1	47,0	0,59	1,01	0,56	10200	7600	21075/21212
0,17	0,38	44,0	41,5	44,0	26,5	26,0	3,0	5,5	40,6	40,9	0,26	2,25	1,24	11300	8400	09081/09195
0,19	0,42	44,0	40,5	43,5	26,5	26,0	3,0	5,5	40,6	40,9	0,26	2,25	1,24	11300	8400	09081/09196
0,13	0,29	42,0	40,0	40,0	28,5	26,5	3,5	3,5	32,2	37,2	0,33	1,80	0,99	11800	8700	LM 12748/LM 12710
0,15	0,33	46,0	44,0	45,0	28,0	26,5	2,5	3,5	42,4	44,6	0,27	2,15	1,18	11000	8200	M 12649 F/M 12610 F
0,17	0,37	45,5	43,0	45,0	28,5	26,0	2,5	3,5	42,4	44,7	0,27	2,15	1,18	11000	8200	M 12649/M 12610
0,12	0,26	42,5	40,0	40,0	28,5	26,5	2,5	3,0	32,1	37,2	0,33	1,80	0,99	11700	8600	LM 12749/LM 12710
0,12	0,27	42,5	40,0	41,0	28,5	26,5	2,5	3,0	32,1	37,2	0,33	1,80	0,99	11500	8500	LM 12749/LM 12711
0,14	0,31	47,5	43,5	44,5	32,0	27,0	2,5	2,0	29,5	32,2	0,33	1,49	0,82	10600	7800	07087/07210 X
0,14	0,31	47,5	43,5	44,5	32,0	27,5	2,5	2,0	29,5	32,2	0,33	1,49	0,82	10600	7800	07087 X/07210 X
0,15	0,33	47,5	43,5	46,8	32,0	27,0	2,5	2,0	29,5	32,2	0,33	1,49	0,82	10400	7700	07087/07204
0,15	0,33	47,5	43,5	46,8	32,0	27,0	2,5	2,0	29,5	32,2	0,33	1,49	0,82	10400	7700	07087 X/07204
0,20	0,44	48,0	45,5	46,5	29,5	27,5	3,0	5,0	45,8	48,8	0,29	2,05	1,13	10500	7800	1380/1328
0,25	0,55	50,5	47,0	51,0	32,0	27,0	3,0	3,0	44,2	47,5	0,31	1,95	1,07	9700	7200	1779/1729 X
0,15	0,32	47,5	43,5	46,8	32,0	30,5	3,0	2,0	29,5	32,2	0,33	1,49	0,82	10000	7400	07097/07204
0,11	0,24	47,0	44,5	46,0	32,0	30,5	4,5	4,0	29,5	32,2	0,40	1,49	0,82	10200	7600	07100/07196
0,12	0,27	47,0	44,5	47,8	32,0	32,0	2,5	3,5	30,8	36,1	0,37	1,60	0,88	10200	7600	07100 S/07196
0,13	0,29	47,0	45,0	45,0	32,5	30,0	2,5	3,5	30,8	36,1	0,37	1,60	0,88	10300	7600	L 44643 RS/L 44610
0,12	0,27	47,0	45,0	45,0	33,0	30,0	2,5	3,5	30,8	36,1	0,37	1,60	0,88	10300	7600	L 44643/L 44610

01.2

INCH SERIES SERIES PULGADAS

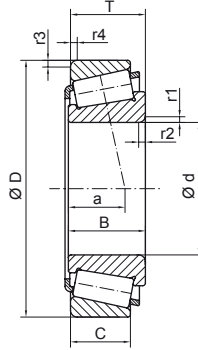

DIMENSIONS / DIMENSIONES												ISO REF / REF ISO	REFERENCES / REFERENCIAS
d		D		T		B		C		r1/r2 min	r3/r4 min		
mm	inch	mm	inch	mm	inch	mm	inch	mm	inch	mm	mm	mm	
25,400	1,000	50,800	2,000	15,011	0,591	14,260	0,561	12,700	0,500	1,5	1,5	12,1	07100 S/07210 X
		51,994	2,047	15,011	0,591	14,260	0,561	12,700	0,500	1,0	1,3	12,1	07100/07204
		56,896	2,240	19,368	0,763	19,837	0,781	15,875	0,625	0,8	1,3	12,5	1780/1729
		57,150	2,250	17,462	0,688	17,462	0,688	13,495	0,531	1,3	1,5	12,5	15578/15520
		57,150	2,250	19,431	0,765	19,431	0,765	14,732	0,580	1,5	1,5	16,3	M 84548/M 84510
		58,738	2,313	19,050	0,750	19,355	0,762	15,080	0,594	1,3	1,3	14,2	1986/1932
		59,530	2,344	23,368	0,920	23,114	0,910	18,288	0,720	0,8	1,5	18,2	M 84249/M 84210
		60,325	2,375	19,845	0,781	19,355	0,762	15,875	0,625	1,3	1,3	14,2	1986/1931
		62,000	2,441	19,050	0,750	20,638	0,813	14,288	0,563	0,8	1,3	13,3	15101/15245
		62,000	2,441	19,050	0,750	20,638	0,813	14,288	0,563	3,5	1,3	13,3	15100/15245
		63,500	2,500	20,638	0,813	20,638	0,813	15,875	0,625	0,8	1,3	14,8	15101/15250
		63,500	2,500	20,638	0,813	20,638	0,813	15,875	0,625	0,8	1,5	14,8	15101/15250 X
63,500	2,500	20,638	0,813	20,638	0,813	15,875	0,625	3,5	1,3	14,8	15100/15250		
63,500	2,500	20,638	0,813	20,638	0,813	15,875	0,625	3,5	1,5	14,8	15100/15250 X		
25,987	1,023	51,986	2,047	15,011	0,591	14,732	0,580	12,700	0,500	3,5	2,0	10,9	L 44645/L 44613
		57,150	2,250	17,462	0,688	17,462	0,688	13,495	0,531	3,5	1,5	12,5	15579 X/15520
26,162	1,030	61,912	2,438	19,050	0,750	19,939	0,785	14,288	0,563	0,8	2,0	13,2	15103 S/15243
		62,000	2,441	19,050	0,750	19,939	0,785	14,288	0,563	0,8	1,3	13,2	15103 S/15245
26,988	1,063	50,292	1,980	14,224	0,560	14,732	0,580	10,668	0,420	3,5	1,3	10,9	L 44649/L 44610
		57,150	2,250	17,462	0,688	17,462	0,688	13,495	0,531	3,5	1,5	12,5	15580/15520
		62,000	2,441	19,050	0,750	20,638	0,813	14,288	0,563	0,8	1,3	13,3	15106/15245
		63,500	2,500	20,638	0,813	20,638	0,813	15,875	0,625	0,8	1,3	14,8	15106/15250
63,500	2,500	20,638	0,813	20,638	0,813	15,875	0,625	0,8	1,5	14,8	15106/15250 X		
28,000	1,102	57,150	2,250	17,462	0,688	17,462	0,688	13,495	0,531	3,5	1,5	12,5	J 15585/15520
28,575	1,125	56,896	2,240	19,845	0,781	19,355	0,762	15,875	0,625	0,8	0,8	16,5	1985/1930
		57,150	2,250	19,845	0,781	19,355	0,762	15,875	0,625	0,8	1,5	14,2	1985/1922
		57,150	2,250	19,845	0,781	19,355	0,762	15,875	0,625	3,5	1,5	14,2	1988/1922
		58,738	2,313	19,050	0,750	19,355	0,762	15,080	0,594	0,8	1,3	14,2	1985/1932
		60,325	2,375	19,845	0,781	19,355	0,762	15,875	0,625	0,8	1,3	14,2	1985/1931
		60,325	2,375	19,845	0,781	19,355	0,762	15,875	0,625	3,5	1,3	14,2	1988/1931
		62,000	2,441	19,050	0,750	20,638	0,813	14,288	0,563	3,5	1,3	13,3	15112/15245
		63,500	2,500	20,638	0,813	20,638	0,813	15,875	0,625	3,5	1,3	14,8	15112/15250

Assembly / Montaje

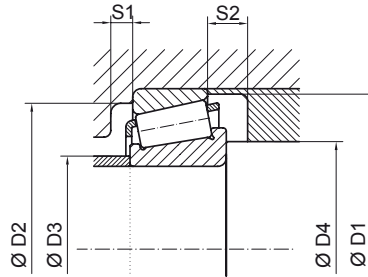

WEIGHT / PESO		ASSEMBLY / MONTAJE							LOAD / CARGA		LOAD FACTORS / FACTORES DE CARGA			SPEED / VELOCIDAD		REFERENCES / REFERENCIAS
		D1 min	D2 min	D2 max	D3 max	D4 min	S1	S2	Dynamic / Dinámica	Static / Estática	Dynamics / Dinámicos	Statics / Estáticos	Yo	Oil / Aceite	Grease / Grasa	
kg	lb	mm	mm	mm	mm	mm	mm	mm	kN	kN	e	Y	Yo	na	ng	
0,13	0,29	47,5	43,5	44,5	32,0	30,5	2,5	2,0	29,5	32,2	0,33	1,49	0,82	10100	7500	07100 S/07210 X
0,14	0,31	47,5	43,5	46,8	32,0	29,0	2,5	2,0	29,5	32,2	0,40	1,49	0,82	10000	7400	07100/07204
0,24	0,53	50,5	47,0	52,0	32,0	28,5	2,5	3,0	44,2	47,5	0,31	1,95	1,07	9700	7200	1780/1729
0,22	0,48	53,0	49,5	51,5	35,5	30,0	2,5	3,5	45,3	52,9	0,34	1,73	0,95	9400	7000	15578/15520
0,23	0,51	53,5	46,0	51,5	33,5	30,5	2,5	4,5	46,1	53,8	0,54	1,10	0,60	9100	6700	M 84548/M 84510
0,25	0,55	54,0	50,0	53,5	35,0	30,0	2,5	3,5	45,5	50,0	0,33	1,81	1,00	9300	6900	1986/1932
0,34	0,75	56,0	45,5	54,0	32,5	28,5	2,5	5,0	53,6	62,4	0,55	1,10	0,60	8900	6500	M 84249/M 84210
0,27	0,59	54,0	50,0	55,0	35,0	30,0	2,5	3,5	45,5	50,1	0,33	1,81	1,00	9100	6800	1986/1931
0,29	0,64	58,0	54,0	57,0	39,0	28,5	3,0	4,5	47,5	54,3	0,35	1,71	0,94	8900	6600	15101/15245
0,29	0,64	58,0	54,0	57,0	39,0	36,5	3,0	4,5	47,5	54,3	0,35	1,71	0,94	8900	6600	15100/15245
0,32	0,71	58,0	53,5	58,5	39,0	28,5	3,0	4,5	47,5	54,3	0,35	1,71	0,94	8800	6500	15101/15250
0,32	0,71	58,0	53,5	57,5	39,0	28,5	3,0	4,5	47,5	54,3	0,35	1,71	0,94	8800	6500	15101/15250 X
0,32	0,71	58,0	53,5	58,5	39,0	36,5	3,0	4,5	47,5	54,3	0,35	1,71	0,94	8800	6500	15100/15250
0,32	0,71	58,0	53,5	57,5	39,0	36,5	3,0	4,5	47,5	54,3	0,35	1,71	0,94	8800	6500	15100/15250 X
0,15	0,32	48,0	45,0	45,0	31,0	37,5	2,5	2,0	30,8	36,1	0,37	1,60	0,88	10000	7400	L 44645/L 44613
0,21	0,46	53,0	49,5	51,5	35,5	37,5	3,0	3,5	45,3	52,9	0,34	1,73	0,95	9400	6900	15579 X/15520
0,29	0,64	58,0	54,0	54,5	38,5	29,5	3,0	4,5	47,5	54,3	0,35	1,71	0,94	8800	6600	15103 S/15243
0,29	0,64	58,0	54,0	57,0	38,5	29,5	3,0	4,5	47,5	54,3	0,35	1,71	0,94	8800	6500	15103 S/15245
0,12	0,26	47,0	45,0	45,0	33,0	38,5	3,0	3,5	30,8	36,1	0,37	1,60	0,88	10000	7400	L 44649/L 44610
0,21	0,46	53,0	49,5	51,5	35,5	38,5	3,0	3,5	45,3	52,9	0,34	1,73	0,95	9300	6900	15580/15520
0,28	0,62	58,0	54,0	57,0	39,0	30,0	3,0	4,5	47,5	54,3	0,35	1,71	0,94	8800	6500	15106/15245
0,31	0,69	58,0	53,5	58,5	39,0	30,0	3,0	4,5	47,5	54,3	0,35	1,71	0,94	8600	6400	15106/15250
0,31	0,69	58,0	53,5	57,5	39,0	30,0	3,0	4,5	47,5	54,3	0,35	1,71	0,94	8600	6400	15106/15250 X
0,20	0,44	53,0	49,5	51,5	35,5	39,5	3,0	3,5	45,3	52,9	0,34	1,73	0,95	9200	6800	J 15585/15520
0,22	0,48	54,0	49,5	52,0	35,0	32,0	3,5	4,0	45,5	50,1	0,33	1,81	1,00	9100	6800	1985/1930
0,21	0,46	54,0	49,5	51,5	35,0	32,0	2,5	3,5	45,5	50,1	0,33	1,81	1,00	9100	6800	1985/1922
0,21	0,47	54,0	49,5	51,5	35,5	40,0	2,5	3,5	45,5	50,1	0,33	1,81	1,00	9100	6800	1988/1922
0,23	0,50	54,0	50,0	53,5	35,0	32,0	2,5	3,5	45,5	50,1	0,33	1,81	1,00	8900	6600	1985/1932
0,26	0,57	54,0	50,0	55,0	35,5	32,0	2,5	3,5	45,5	50,0	0,33	1,81	1,00	8800	6500	1985/1931
0,24	0,53	54,0	50,0	55,0	35,5	40,0	2,5	3,5	45,5	50,1	0,33	1,81	1,00	8800	6500	1988/1931
0,27	0,60	58,0	54,0	57,0	39,0	40,0	2,5	4,5	47,5	54,3	0,35	1,71	0,94	8600	6400	15112/15245
0,30	0,66	58,0	53,5	58,5	39,0	40,0	3,0	4,5	47,5	54,3	0,35	1,71	0,94	8500	6300	15112/15250

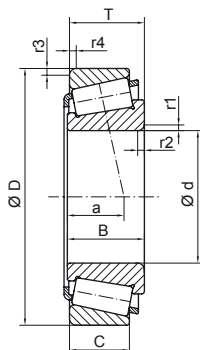

DIMENSIONS / DIMENSIONES												ISO REF / REF ISO	REFERENCES / REFERENCIAS
d		D		T		B		C		r1/r2 min	r3/r4 min		
mm	inch	mm	inch	mm	inch	mm	inch	mm	inch	mm	mm	mm	
28,575	1,125	63,500	2,500	20,638	0,813	20,638	0,813	15,875	0,625	3,5	1,5	14,8	15112/15250 X
		64,292	2,531	21,433	0,844	21,433	0,844	16,670	0,656	1,5	1,5	18,2	M 86647/M 86610
		66,421	2,615	23,812	0,938	25,433	1,001	19,050	0,750	1,3	1,3	14,4	2689/2631
		68,262	2,688	22,225	0,875	22,225	0,875	17,462	0,688	0,8	1,5	17,1	02474/02420
		72,626	2,859	24,608	0,969	24,257	0,955	17,462	0,688	4,8	1,5	20,7	41125/41286
		73,025	2,875	22,225	0,875	22,225	0,875	17,463	0,688	0,8	3,3	18,4	02872/02820
29,000	1,142	50,292	1,980	14,224	0,560	14,732	0,580	10,668	0,420	3,5	1,3	10,9	L 45449/L 45410
29,987	1,181	62,000	2,441	19,050	0,750	20,638	0,813	14,288	0,563	1,3	1,3	13,3	15117/15245
30,000	1,181	69,012	2,717	19,845	0,781	19,202	0,756	15,875	0,625	0,8	3,3	15,9	14118/14274
		72,000	2,835	29,370	1,156	27,783	1,094	23,020	0,906	1,3	3,3	23,4	JHM 88540/JHM 88513
		72,085	2,838	22,385	0,881	19,202	0,756	18,415	0,725	0,8	2,3	18,4	14118/14283
30,162	1,188	64,292	2,531	21,433	0,844	21,433	0,844	16,670	0,656	1,5	1,5	18,2	M 86649/M 86610
		68,262	2,688	22,225	0,875	22,225	0,875	17,462	0,688	2,3	1,5	19,2	M 88043/M 88010
		68,262	2,688	22,225	0,875	22,225	0,875	17,463	0,688	2,3	2,3	19,2	M 88043/M 88011
30,213	1,190	62,000	2,441	19,050	0,750	20,638	0,813	14,288	0,563	3,5	1,3	13,3	15118/15245
		63,500	2,500	20,638	0,813	20,638	0,813	15,875	0,625	0,8	1,5	14,8	15120/15250 X
		63,500	2,500	20,638	0,813	20,638	0,813	15,875	0,625	3,5	1,3	14,8	15118/15250
		63,500	2,500	20,638	0,813	20,638	0,813	15,875	0,625	3,5	1,5	14,8	15118/15250 X
30,226	1,190	69,012	2,717	19,845	0,781	19,583	0,771	15,875	0,625	0,8	1,3	15,9	14116/14276
30,955	1,219	64,292	2,531	21,432	0,844	21,433	0,844	16,670	0,656	1,5	1,5	18,1	M 86648 A/M 86610
31,750	1,250	58,877	2,318	15,875	0,625	16,764	0,660	11,811	0,465	ESP	1,3	13,0	LM 67048/LM 67010 BA
		59,131	2,328	15,875	0,625	16,764	0,660	11,811	0,465	ESP	1,3	13,0	LM 67048/LM 67010
		59,131	2,328	15,875	0,625	16,764	0,660	11,811	0,465	ESP	1,3	13,0	LM 67048 RS/LM 67010
		59,131	2,328	15,875	0,625	16,764	0,660	11,811	0,465	0,8	1,3	13,0	LM 67049 A/LM 67010
		59,131	2,328	15,875	0,625	16,764	0,660	11,811	0,465	0,6	1,3	13,0	LM 67049 AX/LM 67010 X
		59,131	2,328	17,780	0,700	16,764	0,660	13,716	0,540	1,5	1,3	14,8	LM 67049/LM 67011
		61,986	2,440	15,875	0,625	16,764	0,660	11,811	0,465	0,8	1,3	13,0	LM 67049 A/LM 67014
		61,986	2,440	15,875	0,625	16,764	0,660	11,811	0,465	ESP	1,3	13,0	LM 67048/LM 67014
		61,986	2,440	15,875	0,625	16,764	0,660	11,811	0,465	ESP	1,3	13,0	LM 67048/LM 67014 X
		62,000	2,441	18,161	0,715	19,050	0,750	14,288	0,563	ESP	1,3	13,3	15123/15245
		62,000	2,441	19,050	0,750	20,638	0,813	14,288	0,563	0,8	1,3	13,3	15126/15245
		62,000	2,441	19,050	0,750	20,638	0,813	14,288	0,563	3,5	1,3	13,3	15125/15245

Assembly / Montaje

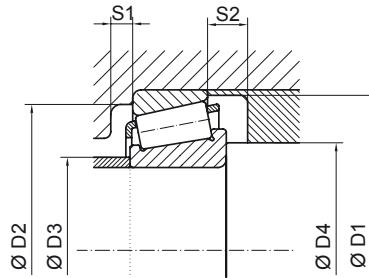

WEIGHT / PESO		ASSEMBLY / MONTAJE							LOAD / CARGA		LOAD FACTORS / FACTORES DE CARGA			SPEED / VELOCIDAD		REFERENCES / REFERENCIAS
		D1 min	D2 min	D2 max	D3 max	D4 min	S1	S2	Dynamic / Dinámica	Static / Estática	Dynamics / Dinámicos	Statics / Estáticos	Oil / Aceite	Grease / Grasa		
kg	lb	mm	mm	mm	mm	mm	mm	mm	C	Co	e	Y	Yo	na	ng	
0,30	0,66	58,0	53,5	57,5	39,0	40,0	3,0	4,5	47,5	54,3	0,35	1,71	0,94	8500	6300	15112/15250 X
0,34	0,75	60,0	51,0	58,5	38,0	34,0	3,0	4,5	56,7	72,2	0,54	1,10	0,60	8100	6000	M 86647/M 86610
0,41	0,90	58,5	55,0	61,5	36,5	33,5	3,5	4,5	70,6	79,9	0,25	2,36	1,30	8300	6200	2689/2631
0,40	0,88	62,5	55,5	62,5	39,5	30,5	3,0	4,5	62,9	74,8	0,42	1,44	0,78	8000	5900	02474/02420
0,46	1,02	67,5	56,5	67,0	47,0	44,0	2,5	7,0	66,2	65,9	0,60	1,00	0,55	7300	5400	41125/41286
0,47	1,03	67,5	60,0	62,0	44,5	32,0	2,5	4,5	59,5	71,1	0,45	1,32	0,72	7500	5600	02872/02820
0,11	0,24	47,5	45,0	45,0	34,5	40,5	3,0	3,5	29,7	38,2	0,37	1,62	0,89	9800	7300	L 45449/L 45410
0,26	0,57	58,0	54,0	57,0	38,5	34,5	3,0	4,5	47,5	54,3	0,35	1,71	0,94	8500	6300	15117/15245
0,36	0,79	63,0	57,5	58,0	43,0	33,0	3,5	3,5	51,7	62,2	0,38	1,57	0,86	7800	5800	14118/14274
0,61	1,34	69,0	55,0	61,0	42,0	34,5	3,5	6,0	78,9	107,1	0,55	1,10	0,60	7400	5500	JHM 88540/JHM 88513
0,44	0,96	63,0	56,0	64,0	43,0	33,0	3,5	3,5	56,1	69,6	0,38	1,57	0,86	7600	5600	14118/14283
0,33	0,72	60,0	51,0	58,5	38,0	35,5	3,5	4,5	56,7	72,2	0,54	1,10	0,60	8000	5900	M 86649/M 86610
0,40	0,87	64,5	54,5	62,5	41,0	38,0	3,5	4,5	60,0	76,9	0,54	1,10	0,60	7600	5700	M 88043/M 88010
0,40	0,88	64,5	54,5	60,0	41,0	38,0	3,5	4,5	60,0	76,9	0,54	1,10	0,60	7600	5700	M 88043/M 88011
0,26	0,57	58,0	54,0	57,0	39,0	41,5	3,5	4,5	47,5	54,3	0,35	1,71	0,94	8400	6300	15118/15245
0,29	0,63	58,0	53,5	57,5	38,5	33,5	3,5	4,5	47,5	54,3	0,35	1,71	0,94	8300	6200	15120/15250 X
0,29	0,64	58,0	53,5	58,5	39,0	41,5	3,5	4,5	47,5	54,3	0,35	1,71	0,94	8300	6200	15118/15250 X
0,29	0,64	58,0	53,5	57,5	39,0	41,5	3,5	4,5	47,5	54,3	0,35	1,71	0,94	8300	6200	15118/15250 X
0,35	0,77	63,0	57,5	64,0	43,0	33,5	3,5	3,5	51,6	62,2	0,38	1,57	0,86	7800	5800	14116/14276
0,32	0,70	60,0	51,0	58,5	38,0	36,5	5,0	4,5	56,7	72,2	0,54	1,10	0,60	7900	5800	M 86648 A/M 86610
0,19	0,41	55,0	51,5	54,0	38,5	45,0	3,5	4,0	39,3	47,5	0,41	1,45	0,80	8500	6300	LM 67048/LM 67010 BA
0,18	0,40	55,0	51,5	54,0	38,5	45,0	3,5	4,0	39,3	47,5	0,41	1,45	0,80	8500	6300	LM 67048/LM 67010
0,19	0,41	55,0	51,5	54,0	38,5	45,0	3,5	4,0	39,3	47,5	0,41	1,45	0,80	8500	6300	LM 67048 RS/LM 67010
0,18	0,40	55,0	51,5	54,0	38,5	35,0	5,0	4,0	39,3	47,5	0,41	1,45	0,80	8500	6300	LM 67049 A/LM 67010
0,18	0,40	55,0	51,5	56,5	38,5	32,5	3,5	4,0	39,3	47,5	0,41	1,45	0,80	8800	6500	LM 67049 AX/LM 67010 X
0,19	0,42	55,0	51,5	54,0	39,0	37,0	3,5	4,0	39,3	47,5	0,41	1,45	0,80	8800	6500	LM 67049/LM 67011
0,21	0,46	55,0	51,5	57,0	39,0	35,0	3,5	4,0	39,3	47,5	0,41	1,45	0,80	8200	6100	LM 67049 A/LM 67014
0,21	0,46	55,0	51,5	57,0	38,5	45,0	3,5	4,0	39,3	47,5	0,41	1,45	0,80	8200	6100	LM 67048/LM 67014
0,20	0,44	55,0	51,5	60,5	38,5	45,0	3,5	4,0	39,3	47,5	0,41	1,45	0,80	8200	6100	LM 67048/LM 67014 X
0,24	0,53	58,0	54,0	57,0	39,0	44,5	3,0	3,5	47,5	54,3	0,35	1,71	0,94	8300	6200	15123/15245
0,25	0,54	58,0	54,0	57,0	39,0	35,0	3,0	4,5	47,5	54,3	0,35	1,71	0,94	8300	6200	15126/15245
0,24	0,53	58,0	54,0	57,0	39,0	43,0	3,0	4,5	47,5	54,2	0,35	1,71	0,94	8300	6200	15125/15245

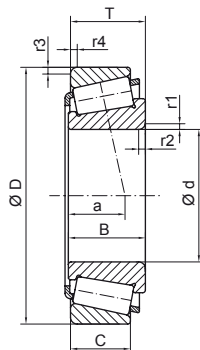

DIMENSIONS / DIMENSIONES												ISO REF / REF ISO	REFERENCES / REFERENCIAS	
d		D		T		B		C		r1/r2 min	r3/r4 min			a
mm	inch	mm	inch	mm	inch	mm	inch	mm	inch	mm	mm	mm		
31,750	1,250	62,000	2,441	19,749	0,778	19,050	0,750	15,875	0,625	ESP	1,3	13,3		15123/15244
		63,500	2,500	19,749	0,778	19,050	0,750	15,875	0,625	ESP	1,5	14,8		15123/15250 X
		63,500	2,500	20,638	0,813	20,638	0,813	15,875	0,625	0,8	1,3	14,8		15126/15250
		63,500	2,500	20,638	0,813	20,638	0,813	15,875	0,625	0,8	1,5	14,8		15126/15250 X
		66,421	2,615	25,400	1,000	25,357	0,998	20,638	0,813	0,8	3,3	16,8		2580/2520
		68,262	2,688	22,225	0,875	22,225	0,875	17,462	0,688	1,5	1,5	19,2		M 88046/M 88010
		68,262	2,688	22,225	0,875	22,225	0,875	17,462	0,688	3,5	1,5	17,1		02475/02420
		69,012	2,717	19,845	0,781	19,583	0,771	15,875	0,625	3,5	1,3	15,9		14125 A/14276
		69,012	2,717	19,845	0,781	19,583	0,771	15,875	0,625	3,5	3,3	15,9		14125 A/14274
		69,012	2,717	26,983	1,062	26,721	1,052	15,875	0,625	4,3	1,3	15,9		14123 AA/14276
69,012	2,717	26,983	1,062	26,721	1,052	15,875	0,625	4,3	3,3	15,9		14123 AA/14274		
69,850	2,750	23,812	0,938	25,357	0,998	19,050	0,750	0,8	1,3	16,8		2580/2523		
72,085	2,838	22,385	0,881	19,583	0,771	18,415	0,725	3,5	2,3	18,4		14125 A/14283		
73,025	2,875	29,370	1,156	27,783	1,094	23,020	0,906	1,3	3,3	23,3		HM 88542/HM 88510		
32,000	1,260	53,000	2,087	14,500	0,571	15,000	0,591	11,500	0,453	6,0	1,3	10,5		JL 26749 F/JL 26710
		66,675	2,625	20,638	0,813	20,638	0,813	15,875	0,625	3,5	1,6	15,1		1680/1620
		68,262	2,688	22,225	0,875	22,225	0,875	17,462	0,688	0,8	1,5	19,2		M 88048/M 88010
		68,262	2,688	22,225	0,875	22,225	0,875	17,463	0,688	0,8	2,3	19,2		M 88048/M 88011
		69,012	2,717	19,845	0,781	19,583	0,771	15,875	0,625	0,8	1,3	15,9		14131/14276
		69,012	2,717	19,845	0,781	19,583	0,771	15,875	0,625	0,8	3,3	15,9		14131/14274
		69,012	2,717	19,845	0,781	19,583	0,771	15,875	0,625	3,5	1,3	15,9		14130/14276
		69,012	2,717	19,845	0,781	19,583	0,771	15,875	0,625	3,5	3,3	15,9		14130/14274
		69,850	2,750	23,812	0,938	25,357	0,998	19,050	0,750	3,5	1,3	16,8		2585/2523
		73,025	2,875	29,370	1,156	27,783	1,094	23,020	0,906	0,8	3,3	23,3		HM 88547/HM 88510
76,200	3,000	29,370	1,156	28,575	1,125	23,020	0,906	0,8	3,3	23,8		HM 89443/HM 89410		
79,375	3,125	29,370	1,156	29,771	1,172	23,812	0,938	3,5	3,3	20,8		3477/3420		
34,925	1,375	65,088	2,563	18,034	0,710	18,288	0,720	13,970	0,550	ESP	1,3	14,2		LM 48548 RS/LM 48510
		65,088	2,563	18,034	0,710	18,288	0,720	13,970	0,550	ESP	1,3	14,2		LM 48548/LM 48510
		68,262	2,688	18,034	0,710	18,288	0,720	13,970	0,550	ESP	1,2	14,2		LM 48548/LM 48514 XP
		68,262	2,688	20,638	0,813	20,638	0,813	15,875	0,625	3,5	2,3	14,8		14585/14525
		69,012	2,717	19,845	0,781	19,583	0,771	15,875	0,625	0,5	1,3	15,9		14137 AS/14276
		69,012	2,717	19,845	0,781	19,583	0,771	15,875	0,625	1,5	1,3	15,9		14137 A/14276

Assembly / Montaje

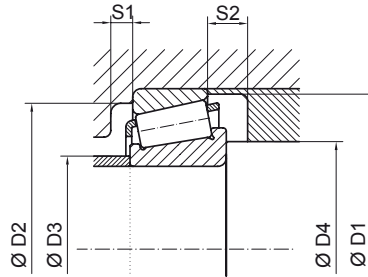

WEIGHT / PESO		ASSEMBLY / MONTAJE							LOAD / CARGA		LOAD FACTORS / FACTORES DE CARGA			SPEED / VELOCIDAD		REFERENCES / REFERENCIAS
		D1 min	D2 min	D2 max	D3 max	D4 min	S1	S2	Dynamic / Dinámica	Static / Estática	Dynamics / Dinámicos	Statics / Estáticos	Yo	Oil / Aceite	Grease / Grasa	
kg	lb	mm	mm	mm	mm	mm	mm	mm	C	Co	e	Y	Yo	na	ng	
0,15	0,34	58,0	53,5	57,0	39,0	44,5	3,0	3,5	47,5	54,3	0,35	1,71	0,94	8300	6200	15123/15244
0,27	0,59	58,0	53,5	57,5	39,0	44,5	3,5	3,5	47,5	54,3	0,35	1,71	0,94	8200	6100	15123/15250 X
0,28	0,62	58,0	53,5	58,5	39,0	35,0	3,5	4,5	47,5	54,3	0,35	1,71	0,94	8200	6100	15126/15250
0,28	0,61	58,0	53,5	57,5	39,0	35,0	3,5	4,5	47,5	54,3	0,35	1,71	0,94	8200	6100	15126/15250 X
0,40	0,87	63,0	58,0	55,5	41,0	35,0	4,5	4,5	77,1	91,9	0,27	2,19	1,20	8000	5900	2580/2520
0,39	0,85	64,5	54,5	62,5	41,5	37,0	3,5	4,5	60,0	76,9	0,54	1,10	0,60	7500	5600	M 88046/M 88010
0,40	0,88	62,5	62,5	55,5	39,5	43,0	3,5	4,5	62,9	74,8	0,42	1,44	0,78	7700	5700	02475/02420
0,35	0,77	63,0	57,5	64,0	43,0	43,0	3,5	3,5	51,7	62,2	0,38	1,57	0,86	7700	5700	14125 A/14276
0,35	0,77	63,0	57,5	58,0	43,0	43,0	3,5	3,5	51,7	62,2	0,38	1,57	0,86	7700	5700	14125 A/14274
0,39	0,86	63,0	57,5	64,0	43,5	45,5	3,5	11,0	51,6	62,3	0,38	1,57	0,86	7700	5700	14123 AA/14276
0,40	0,87	63,0	57,5	58,0	43,5	45,5	3,5	11,0	51,6	62,3	0,38	1,57	0,86	7700	5700	14123 AA/14274
0,44	0,96	63,0	59,0	64,5	41,0	35,0	3,5	4,5	77,1	91,9	0,27	2,19	1,20	7700	5700	2580/2523
0,43	0,94	63,0	56,0	64,0	43,0	43,0	3,5	3,5	51,7	62,2	0,38	1,57	0,86	7500	5500	14125 A/14283
0,63	1,38	69,0	55,0	62,0	42,0	36,5	3,5	6,0	78,8	107,1	0,55	1,10	0,60	7200	5300	HM 88542/HM 88510
0,12	0,26	50,0	48,0	48,0	41,0	44,0	3,5	3,0	30,9	42,1	0,33	1,80	0,99	9200	6800	JL 26749 F/JL 26710
0,31	0,67	61,5	56,0	60,5	42,0	44,5	3,5	4,5	49,7	58,5	0,37	1,61	0,89	7800	5800	1680/1620
0,37	0,82	64,5	54,5	62,5	41,5	36,5	3,5	4,5	60,0	76,9	0,54	1,10	0,60	7400	5500	M 88048/M 88010
0,38	0,83	64,5	54,5	60,0	41,5	36,5	3,5	4,5	60,0	76,9	0,54	1,10	0,60	7400	5500	M 88048/M 88011
0,34	0,75	63,0	57,5	64,0	43,0	36,5	3,5	3,5	51,7	62,2	0,38	1,57	0,86	7600	5600	14131/14276
0,34	0,74	63,0	57,5	58,0	43,0	36,5	3,5	3,5	51,7	62,2	0,38	1,57	0,86	7600	5600	14131/14274
0,34	0,74	63,0	57,5	64,0	43,0	44,5	3,5	3,5	51,7	62,2	0,38	1,57	0,86	7600	5600	14130/14276
0,34	0,74	63,0	57,5	58,0	43,0	44,5	3,5	3,5	51,7	62,2	0,38	1,57	0,86	7600	5600	14130/14274
0,42	0,93	63,0	59,0	64,5	40,5	44,5	4,5	4,5	77,0	91,8	0,27	2,19	1,20	7700	5700	2585/2523
0,61	1,34	72,0	55,0	62,0	42,0	36,5	3,5	6,0	78,8	107,1	0,55	1,10	0,60	7100	5200	HM 88547/HM 88510
0,66	1,46	72,0	58,0	65,0	44,5	36,5	3,5	6,0	83,8	114,3	0,54	1,10	0,60	6900	5100	HM 89443/HM 89410
0,46	1,02	73,0	64,5	68,2	46,0	44,5	3,5	5,5	94,7	114,8	0,36	1,64	0,90	6900	5100	3477/3420
0,26	0,57	61,0	56,5	60,0	42,0	47,5	3,5	4,0	52,1	64,0	0,37	1,59	0,87	7800	5700	LM 48548 RS/LM 48510
0,25	0,55	61,0	56,5	60,0	42,0	47,5	3,5	4,0	52,1	64,0	0,37	1,59	0,87	7800	5700	LM 48548/LM 48510
0,28	0,62	61,0	57,0	63,5	42,0	47,5	3,5	4,0	52,1	64,0	0,37	1,59	0,87	7500	5600	LM 48548/LM 48514 XP
0,32	0,70	62,3	57,7	60,1	42,6	46,0	3,5	4,5	54,6	66,4	0,35	1,70	0,93	7500	5600	14585/14525
0,33	0,72	63,0	57,5	64,0	43,0	37,0	3,5	3,5	51,7	62,2	0,38	1,57	0,86	7500	5500	14137 AS/14276
0,33	0,72	63,0	57,5	64,0	43,0	40,0	3,5	3,5	51,7	62,2	0,38	1,57	0,86	7500	5500	14137 A/14276

01.2

INCH SERIES SERIES PULGADAS

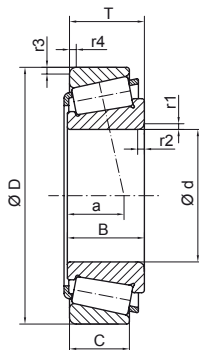

DIMENSIONS / DIMENSIONES												ISO REF / REF ISO	REFERENCES / REFERENCIAS
d		D		T		B		C		r1/r2 min	r3/r4 min		
mm	inch	mm	inch	mm	inch	mm	inch	mm	inch	mm	mm	mm	
34,925	1,375	69,012	2,717	19,845	0,781	19,583	0,771	15,875	0,625	1,5	3,3	15,9	14137 A/14274
		69,012	2,717	19,845	0,781	19,583	0,771	15,875	0,625	3,5	1,3	15,9	14138 A/14276
		69,012	2,717	19,845	0,781	19,583	0,771	15,875	0,625	3,5	3,3	15,9	14138 A/14274
		69,012	2,717	26,983	1,062	26,721	1,052	15,875	0,625	0,8	1,3	15,9	14136 A/14276
		72,085	2,838	22,385	0,881	19,583	0,771	18,415	0,725	3,5	2,3	18,4	14138 A/14283
		72,233	2,844	25,400	1,000	25,400	1,000	19,842	0,781	2,3	2,3	20,2	HM 88649/HM 88610
		73,025	2,875	23,812	0,938	24,608	0,969	19,050	0,750	1,5	0,8	15,5	25877/25821
		73,025	2,875	23,812	0,938	24,608	0,969	19,050	0,750	1,5	2,3	15,5	25877/25820
		73,025	2,875	23,812	0,938	24,608	0,969	19,050	0,750	3,5	2,3	15,5	25878/25820
		73,025	2,875	23,812	0,938	25,654	1,010	19,050	0,750	3,5	0,8	15,8	2796/2735 X
		73,025	2,875	26,988	1,063	26,975	1,062	22,225	0,875	3,5	1,5	19,0	23690/23620
		76,200	3,000	23,813	0,938	25,654	1,010	19,050	0,750	0,8	3,3	15,8	2793/2720
		76,200	3,000	29,370	1,156	28,575	1,125	23,020	0,906	3,5	3,3	23,8	HM 88446/HM 88410
		76,200	3,000	29,370	1,156	28,575	1,125	23,813	0,938	1,5	3,3	20,7	31594/31520
76,200	3,000	29,370	1,156	28,575	1,125	23,813	0,938	3,5	3,3	20,7	31593/31520		
79,375	3,125	29,370	1,156	29,771	1,172	23,812	0,938	3,5	3,3	20,5	3478/3420		
80,035	3,151	21,433	0,844	20,940	0,824	15,875	0,625	1,5	1,5	16,6	28137/28317		
34,987	1,377	59,131	2,328	15,875	0,625	16,764	0,660	11,938	0,470	1,1	1,3	13,3	L 68149 R/L 68110
		59,131	2,328	15,875	0,625	16,764	0,660	11,938	0,470	ESP	1,3	13,3	L 68149/L 68110
		59,975	2,361	15,875	0,625	16,764	0,660	11,938	0,470	ESP	1,3	13,3	L 68149/L 68111
		61,975	2,440	16,700	0,658	17,000	0,669	13,600	0,535	ESP	1,5	14,5	LM 78349/LM 78310 A
		65,088	2,563	15,875	0,625	16,764	0,660	11,938	0,470	ESP	1,3	13,3	L 68149/L 68116
35,000	1,378	60,000	2,362	15,875	0,625	18,460	0,727	11,938	0,470	2,0	1,3	13,3	JL 68145/JL 68111 Z
35,717	1,406	72,233	2,844	25,400	1,000	25,400	1,000	19,842	0,781	3,5	2,3	20,2	HM 88648/HM 88610
36,487	1,437	73,025	2,875	23,812	0,938	24,608	0,969	19,050	0,750	1,5	0,8	15,5	25880/25821
		73,025	2,875	23,812	0,938	24,608	0,969	19,050	0,750	1,5	2,3	15,5	25880/25820
		76,200	3,000	23,812	0,938	25,654	1,010	19,050	0,750	1,5	0,8	15,8	2780/2729
		76,200	3,000	23,812	0,938	25,654	1,010	19,050	0,750	1,5	3,3	15,8	2780/2720
36,512	1,438	76,200	3,000	29,370	1,156	28,575	1,125	23,020	0,906	0,8	3,3	23,8	HM 88448/HM 88410
		76,200	3,000	29,370	1,156	28,575	1,125	23,020	0,906	3,5	3,3	23,8	HM 88449/HM 88410
		85,725	3,375	30,162	1,188	30,162	1,188	23,812	0,938	0,8	3,3	22,2	3878/3820
38,000	1,496	63,000	2,480	17,000	0,669	17,000	0,669	13,500	0,532	ESP	1,5	14,7	JL 69349/JL 69310

Assembly / Montaje

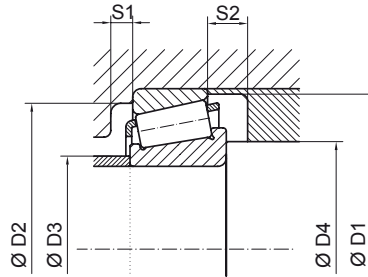

WEIGHT / PESO		ASSEMBLY / MONTAJE							LOAD / CARGA		LOAD FACTORS / FACTORES DE CARGA			SPEED / VELOCIDAD		REFERENCES / REFERENCIAS
									Dynamic / Dinámica	Static / Estática	Dynamics / Dinámicos	Statics / Estáticos	Oil / Aceite	Grease / Grasa		
kg	lb	D1 min	D2 min	D2 max	D3 max	D4 min	S1	S2	C	Co	e	Y	Yo	na	ng	
		mm	mm	mm	mm	mm	mm	mm	kN	kN				rpm	rpm	
0,32	0,71	63,0	57,5	58,0	43,0	40,0	3,5	3,5	51,7	62,2	0,38	1,57	0,86	7500	5500	14137 A/14274
0,32	0,71	63,0	57,5	64,0	43,0	46,0	3,5	3,5	51,7	62,2	0,38	1,57	0,86	7500	5500	14138 A/14276
0,32	0,71	63,0	57,5	58,0	43,0	46,0	3,5	3,5	51,7	62,2	0,38	1,57	0,86	7500	5500	14138 A/14274
0,36	0,78	63,0	57,5	64,0	43,5	38,0	3,5	11,0	51,7	62,2	0,38	1,57	0,86	7500	5500	14136 A/14276
0,40	0,88	63,0	56,0	64,0	43,0	46,0	3,5	3,5	51,7	62,2	0,38	1,57	0,86	7200	5400	14138 A/14283
0,48	1,05	68,0	57,0	64,0	43,0	42,5	3,5	5,5	70,5	92,2	0,54	1,10	0,60	7000	5200	HM 88649/HM 88610
0,46	1,01	67,0	62,5	69,5	44,5	40,0	4,0	4,5	79,9	96,7	0,29	2,06	1,13	7300	5400	25877/25821
0,46	1,01	67,0	62,5	65,0	44,5	40,0	4,0	4,5	79,9	96,7	0,29	2,06	1,13	7300	5400	25877/25820
0,46	1,02	67,0	62,5	65,0	44,5	46,0	4,0	4,5	79,9	96,7	0,29	2,06	1,13	7300	5400	25878/25820
0,47	1,04	69,5	64,5	69,5	46,5	46,0	4,0	4,5	83,0	105,1	0,30	1,97	1,08	7300	5400	2796/2735 X
0,51	1,12	67,5	59,5	67,5	42,5	46,0	3,5	4,5	81,8	99,1	0,37	1,62	0,89	7200	5300	23690/23620
0,54	1,18	69,5	64,5	65,0	46,5	38,0	4,0	4,5	83,0	105,1	0,30	1,97	1,08	7100	5200	2793/2720
0,64	1,40	72,0	58,0	65,0	44,5	46,0	3,5	6,0	83,8	114,3	0,54	1,10	0,60	6800	5000	HM 89446/HM 89410
0,62	1,36	71,5	61,5	65,0	45,0	40,0	3,5	5,5	90,4	110,7	0,40	1,49	0,82	7000	5200	31594/31520
0,62	1,36	71,5	61,5	65,0	45,0	46,0	3,5	5,5	90,4	110,7	0,40	1,49	0,82	7000	5200	31593/31520
0,70	1,54	73,0	64,5	68,2	46,0	46,0	3,5	5,5	94,6	114,8	0,36	1,64	0,90	6800	5000	3478/3420
0,49	1,09	70,5	65,0	74,5	48,0	40,0	3,5	5,5	62,1	71,7	0,40	1,49	0,82	6700	5000	28137/28317
0,17	0,38	56,2	52,3	54,0	41,0	39,0	3,5	3,5	38,7	51,6	0,42	1,44	0,79	8200	6100	L 68149 R/L 68110
0,17	0,38	56,2	52,3	54,0	40,8	47,0	3,5	3,5	38,7	51,6	0,42	1,44	0,79	8200	6100	L 68149/L 68110
0,18	0,39	56,2	52,3	55,0	40,8	47,0	3,5	3,5	38,7	51,6	0,42	1,44	0,79	8100	6000	L 68149/L 68111
0,21	0,45	59,0	54,0	60,5	35,0	48,0	3,5	3,0	43,6	57,6	0,44	1,35	0,74	7900	5900	LM 78349/LM 78310 A
0,21	0,47	56,0	52,5	60,0	40,8	47,0	3,5	3,5	38,7	51,6	0,42	1,44	0,79	7700	5700	L 68149/L 68116
0,19	0,41	56,2	52,3	55,0	40,8	42,0	3,5	3,5	38,7	51,6	0,42	1,44	0,79	8100	6000	JL 68145/JL 68111 Z
0,48	1,06	68,0	57,0	64,0	43,0	47,0	3,5	5,5	70,5	92,2	0,54	1,10	0,60	7000	5200	HM 88648/HM 88610
0,44	0,97	67,0	62,5	69,5	44,5	42,0	4,0	4,5	79,9	96,7	0,29	2,06	1,13	7200	5300	25880/25821
0,44	0,97	67,0	62,5	65,0	44,5	42,0	4,0	4,5	79,9	96,7	0,29	2,06	1,13	7200	5300	25880/25820
0,52	1,13	69,5	64,5	72,5	46,5	42,0	4,0	4,5	83,0	105,1	0,30	1,97	1,08	7000	5200	2780/2729
0,51	1,11	69,5	64,5	65,0	46,5	42,0	4,0	4,5	83,0	105,1	0,30	1,97	1,08	7000	5200	2780/2720
0,64	1,41	72,0	58,0	65,0	44,5	39,5	3,5	6,0	83,8	114,3	0,54	1,10	0,60	6700	4900	HM 89448/HM 89410
0,62	1,36	72,0	58,0	65,0	44,5	48,0	3,5	6,0	83,8	114,3	0,54	1,10	0,60	6700	4900	HM 89449/HM 89410
0,85	1,87	80,5	70,5	74,5	50,5	39,5	3,5	6,0	111,7	141,1	0,40	1,49	0,82	6300	4700	3878/3820
0,21	0,46	60,0	55,5	57,5	43,5	50,5	3,5	3,5	42,3	57,2	0,42	1,44	0,79	7600	5700	JL 69349/JL 69310

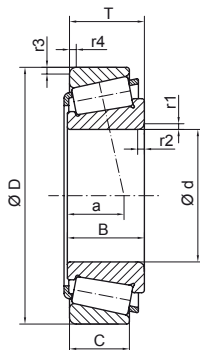

DIMENSIONS / DIMENSIONES												ISO REF / REF ISO	REFERENCES / REFERENCIAS	
d		D		T		B		C		r1/r2 min	r3/r4 min			a
mm	inch	mm	inch	mm	inch	mm	inch	mm	inch	mm	mm	mm		
38,000	1,496	63,000	2,480	17,000	0,669	19,000	0,748	13,500	0,532	ESP	1,3	14,7		JL 69345/JL 69310 Z
		63,000	2,480	17,000	0,669	19,000	0,748	13,500	0,532	ESP	1,5	14,7		JL 69345/JL 69310
38,100	1,500	65,088	2,563	12,700	0,500	11,908	0,469	9,525	0,375	1,5	0,8	11,9		13889/13836
		65,088	2,563	18,034	0,710	18,288	0,720	13,970	0,550	2,3	1,3	13,6		LM 29749/LM 29710
		65,088	2,563	18,034	0,710	18,288	0,720	13,970	0,550	ESP	1,3	13,6		LM 29748/LM 29710
		65,088	2,563	18,034	0,710	18,288	0,720	15,748	0,620	ESP	1,3	13,6		LM 29748/LM 29711
		65,088	2,563	19,812	0,780	18,288	0,720	15,748	0,620	2,3	1,3	15,4		LM 29749/LM 29711
		68,262	2,688	15,875	0,625	16,520	0,650	11,908	0,469	1,5	1,5	18,6		19150/19268
		69,012	2,717	19,050	0,750	19,050	0,750	15,083	0,594	2,0	0,8	15,9		13687/13620
		69,012	2,717	19,050	0,750	19,050	0,750	15,083	0,594	2,0	2,3	15,9		13687/13621
		69,012	2,717	19,050	0,750	19,050	0,750	15,083	0,594	3,5	2,3	15,9		13685/13621
		69,012	2,717	26,195	1,031	26,195	1,031	15,083	0,594	1,5	0,8	15,9		13686/13620
		72,238	2,844	20,638	0,813	20,638	0,813	15,875	0,625	3,5	1,3	16,6		16150/16284
		76,200	3,000	23,812	0,938	25,654	1,010	19,050	0,750	3,5	0,8	15,8		2788/2729
		76,200	3,000	23,812	0,938	25,654	1,010	19,050	0,750	3,5	3,3	15,8		2788/2720
		76,200	3,000	25,400	1,000	25,400	1,000	20,638	0,813	0,8	1,5	22,1		26878/26823
79,375	3,125	29,370	1,156	29,771	1,172	23,812	0,938	3,5	3,3	20,8		3490/3420		
80,167	3,156	29,370	1,156	30,391	1,197	23,812	0,938	3,5	3,3	18,3		3381/3320		
82,550	3,250	29,370	1,156	28,575	1,125	23,020	0,906	0,8	3,3	24,6		HM 801346/HM 801310		
82,550	3,250	29,370	1,156	28,575	1,125	23,020	0,906	2,3	3,3	24,6		HM 801346 X/HM 801310		
88,500	3,484	26,988	1,063	29,083	1,145	22,225	0,875	3,5	1,5	17,3		418/414		
39,688	1,563	76,200	3,000	23,812	0,938	25,654	1,010	19,050	0,750	3,5	0,8	15,8		2789/2729
		76,200	3,000	23,812	0,938	25,654	1,010	19,050	0,750	3,5	3,3	15,8		2789/2720
		79,975	3,149	29,370	1,156	30,391	1,197	23,812	0,938	0,8	3,3	18,3		3386/3325
		80,167	3,156	29,370	1,156	30,391	1,197	23,812	0,938	0,8	3,3	18,3		3386/3320
		80,167	3,156	29,370	1,156	30,391	1,197	23,812	0,938	3,5	3,3	18,3		3382/3320
		90,488	3,563	39,688	1,563	40,386	1,590	33,338	1,313	1,5	3,3	24,4		4367 X/4335
39,987	1,574	90,975	3,582	32,000	1,260	32,000	1,260	26,500	1,043	1,0	3,5	22,1		HM 204043/HM 204010
40,000	1,575	73,025	2,875	30,162	1,188	30,162	1,188	17,463	0,688	0,8	3,3	22,2		3879/3820
		80,000	3,150	21,000	0,827	22,403	0,882	17,826	0,702	3,5	1,3	14,6		344/332
		85,000	3,347	33,000	1,299	32,500	1,280	28,000	1,102	2,5	2,0	22,6	T2EE040	JF 4049/JF 4010
40,987	1,614	67,975	2,676	17,500	0,689	18,000	0,709	13,500	0,532	ESP	1,5	13,8		LM 300849/LM 300811

Assembly / Montaje

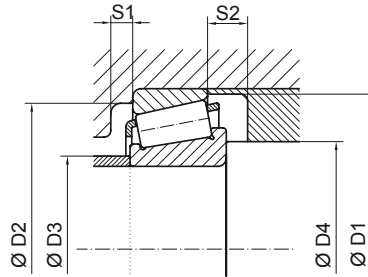

WEIGHT / PESO		ASSEMBLY / MONTAJE							LOAD / CARGA		LOAD FACTORS / FACTORES DE CARGA			SPEED / VELOCIDAD		REFERENCES / REFERENCIAS
									Dynamic / Dinámica	Static / Estática	Dynamics / Dinámicos	Statics / Estáticos	Oil / Aceite	Grease / Grasa		
kg	lb	D1 min	D2 min	D2 max	D3 max	D4 min	S1	S2	C	Co	e	Y	Yo	na	ng	
		mm	mm	mm	mm	mm	mm	mm	kN	kN				rpm	rpm	
0,22	0,48	60,0	55,5	58,0	43,5	49,5	3,5	3,5	42,3	57,2	0,42	1,44	0,79	7600	5700	JL 69345/JL 69310 Z
0,20	0,44	60,0	55,5	57,5	43,5	49,5	3,5	3,5	42,3	57,2	0,42	1,44	0,79	7600	5700	JL 69345/JL 69310
0,16	0,35	60,0	58,5	61,5	47,0	43,5	3,5	3,0	27,6	36,2	0,35	1,73	0,95	7600	5600	13889/13836
0,23	0,50	61,0	58,0	60,0	45,0	46,0	3,5	4,0	47,1	62,2	0,33	1,80	0,99	7600	5600	LM 29749/LM 29710
0,23	0,50	61,0	58,0	60,0	45,0	50,5	3,5	4,0	47,1	62,2	0,33	1,80	0,99	7600	5600	LM 29748/LM 29710
0,23	0,50	61,0	57,0	60,0	45,0	50,5	3,5	2,0	47,1	62,1	0,33	1,80	0,99	7600	5600	LM 29748/LM 29711
0,25	0,54	61,0	57,0	60,0	45,0	46,0	3,5	4,0	47,1	62,2	0,33	1,80	0,99	7600	5600	LM 29749/LM 29711
0,23	0,51	64,5	60,5	62,5	46,0	43,5	4,0	3,5	50,9	62,1	0,44	1,35	0,74	7200	5300	19150/19268
0,29	0,63	65,0	60,0	65,5	45,5	45,0	4,0	3,5	53,6	67,9	0,40	1,49	0,82	7200	5300	13687/13620
0,29	0,63	65,0	59,5	61,0	45,5	45,0	4,0	3,5	53,6	67,9	0,40	1,49	0,82	7200	5300	13687/13621
0,29	0,63	65,0	59,5	61,0	46,0	49,5	4,0	3,5	53,6	67,9	0,40	1,49	0,82	7200	5300	13685/13621
0,35	0,77	65,0	60,0	65,5	45,4	43,5	4,0	11,0	53,6	67,9	0,40	1,49	0,82	7200	5300	13686/13620
0,35	0,77	66,0	60,5	71,0	45,0	41,5	3,5	4,5	53,8	65,5	0,40	1,49	0,82	7000	5200	16150/16284
0,50	1,10	69,5	64,5	72,5	46,5	49,5	4,0	4,5	83,0	105,1	0,30	1,97	1,08	6900	5100	2788/2729
0,50	1,09	69,5	64,5	65,0	46,5	49,5	4,0	4,5	83,0	105,1	0,30	1,97	1,08	6900	5100	2788/2720
0,53	1,17	73,0	67,0	70,5	49,5	41,5	3,5	4,5	83,9	107,4	0,32	1,88	1,03	6800	5100	26878/26823
0,65	1,43	73,0	64,5	68,2	46,0	49,5	3,5	5,5	94,7	114,9	0,36	1,64	0,90	6600	4900	3490/3420
0,67	1,48	75,0	68,5	69,0	47,9	49,5	4,0	5,5	104,9	125,1	0,27	2,20	1,21	6700	4900	3381/3320
0,75	1,65	78,0	64,0	71,5	45,5	41,5	3,5	6,0	97,3	133,5	0,54	1,10	0,60	6200	4600	HM 801346/HM 801310
0,75	1,65	78,0	64,0	71,5	45,5	46,0	3,5	6,0	97,3	133,5	0,54	1,10	0,60	6200	4600	HM 801346 X/HM 801310
0,82	1,80	78,5	73,0	82,5	49,5	49,5	5,5	4,5	111,6	129,6	0,26	2,27	1,25	6200	4600	418/414
0,48	1,05	69,5	64,5	72,5	46,5	51,0	4,0	4,5	83,0	105,1	0,30	1,97	1,08	6800	5000	2789/2729
0,48	1,05	69,5	64,5	65,0	46,5	51,0	4,0	4,5	83,0	105,1	0,30	1,97	1,08	6800	5000	2789/2720
0,64	1,41	75,0	69,5	69,0	47,9	43,0	4,0	5,5	104,9	125,2	0,27	2,20	1,21	6600	4900	3386/3325
0,65	1,43	75,0	68,5	69,0	47,9	43,0	4,0	5,5	104,9	125,1	0,27	2,20	1,21	6600	4900	3386/3320
0,65	1,44	75,0	68,5	69,0	48,5	51,0	4,0	5,5	104,9	125,1	0,27	2,20	1,21	6600	4900	3382/3320
1,27	2,78	84,0	74,0	79,5	52,0	44,0	3,5	6,0	146,9	190,4	0,28	2,11	1,16	6000	4500	4367 X/4335
0,57	1,25	86,0	77,0	79,0	55,5	44,0	4,0	5,5	74,7	83,3	0,27	2,20	1,21	6000	4400	HM 204043/HM 204010
0,81	1,77	67,5	60,0	62,0	51,0	43,0	4,0	12,5	111,7	141,0	0,40	1,49	0,82	6300	4700	3879/3820
0,57	1,25	75,0	71,5	75,0	51,0	51,5	4,5	3,0	74,7	83,3	0,27	2,20	1,21	6600	4900	344/332
0,86	1,89	80,0	70,5	77,5	49,5	48,5	4,0	5,0	123,4	152,7	0,34	1,74	0,96	6200	4600	JF 4049/JF 4010
0,24	0,53	64,0	60,5	62,0	47,0	53,0	4,0	4,0	48,3	65,4	0,35	1,72	0,94	7200	5300	LM 300849/LM 300811

01.2

INCH SERIES SERIES PULGADAS

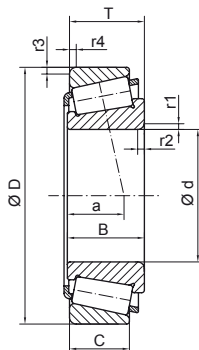

DIMENSIONS / DIMENSIONES												ISO REF / REF ISO	REFERENCES / REFERENCIAS
d		D		T		B		C		r1/r2 min	r3/r4 min		
mm	inch	mm	inch	mm	inch	mm	inch	mm	inch	mm	mm	mm	
41,275	1,6235	73,025	2,875	16,067	0,656	17,462	0,688	12,700	0,500	3,5	1,5	13,9	18590/18520
		73,431	2,881	19,558	0,770	19,812	0,780	14,732	0,580	3,5	0,8	16,2	LM 501349/LM 501310
		73,431	2,881	21,430	0,844	19,812	0,780	16,604	0,654	3,5	0,8	18,1	LM 501349/LM 501314
		76,200	3,000	18,009	0,709	17,384	0,684	14,288	0,563	0,8	1,5	17,1	11163/11300
		76,200	3,000	18,009	0,709	17,384	0,684	14,288	0,563	1,5	1,5	17,1	11162/11300
		76,200	3,000	22,225	0,875	23,020	0,906	17,463	0,688	0,8	0,8	17,4	24781/24720
		76,200	3,000	22,225	0,875	23,020	0,906	17,463	0,688	3,5	0,8	17,4	24780/24720
		76,200	3,000	25,400	1,000	23,020	0,906	20,638	0,813	0,8	2,3	20,6	24781/24721
		76,200	3,000	25,400	1,000	23,020	0,906	20,638	0,813	3,5	2,3	20,6	24780/24721
		79,375	3,125	23,812	0,938	25,400	1,000	19,050	0,750	1,5	0,8	16,4	26882 T/26822
		79,375	3,125	23,812	0,938	25,400	1,000	19,050	0,750	3,5	0,8	16,4	26882/26822
		80,000	3,150	21,000	0,827	22,403	0,882	17,826	0,702	0,8	1,3	14,6	336/332
		80,000	3,150	28,574	1,125	29,977	1,180	17,826	0,702	3,5	1,3	14,6	342 A/332
		80,167	3,156	25,400	1,000	25,400	1,000	20,638	0,813	3,5	3,3	18,0	26882/26820
		80,167	3,156	29,370	1,156	30,391	1,197	23,812	0,938	0,8	3,3	18,3	3384/3320
		82,550	3,250	26,543	1,045	25,654	1,010	20,193	0,795	3,5	3,3	23,3	M 802048/M 802011
		84,138	3,313	30,162	1,188	30,866	1,215	23,812	0,938	3,5	3,3	19,8	3577/3520
		85,725	3,375	30,162	1,188	30,162	1,188	23,812	0,938	3,5	3,3	22,2	3877/3820
		87,312	3,438	30,162	1,188	30,866	1,215	23,812	0,938	1,5	3,3	19,9	3585/3525
		87,312	3,438	30,162	1,188	30,866	1,215	23,812	0,938	3,5	3,3	19,9	3577/3525
		88,500	3,484	25,400	1,000	23,698	0,933	17,462	0,688	2,3	1,5	28,0	44162/44348
		88,500	3,484	26,988	1,063	29,083	1,145	22,225	0,875	3,5	1,5	17,3	419/414
		88,900	3,500	30,163	1,188	29,370	1,156	23,020	0,906	0,8	3,3	25,5	HM 803145/HM 803110
		88,900	3,500	30,162	1,188	29,370	1,156	23,020	0,906	3,5	3,3	25,5	HM 803146/HM 803110
		90,488	3,563	39,688	1,563	40,386	1,590	33,338	1,313	3,5	3,3	25,6	4388/4335
		93,662	3,688	31,750	1,250	31,750	1,250	25,400	1,000	3,5	3,3	22,4	49162/49368
		95,250	3,750	30,162	1,188	29,370	1,156	23,020	0,906	3,5	3,3	25,9	HM 804840/HM804810
		95,250	3,750	30,958	1,219	28,575	1,125	22,225	0,875	3,5	0,8	31,4	HM 903245/HM 903210
		104,775	4,125	36,512	1,438	36,512	1,438	28,575	1,125	1,5	3,3	26,4	59162/59412
42,070	1,656	90,488	3,563	39,688	1,563	40,386	1,590	33,338	1,313	3,5	3,3	25,6	4395/4335
42,862	1,688	82,931	3,265	23,812	0,938	25,400	1,000	19,050	0,750	2,3	0,8	17,4	25578/25520
		82,931	3,265	23,812	0,938	25,400	1,000	19,050	0,750	3,5	0,8	17,4	25576/25520

Assembly / Montaje

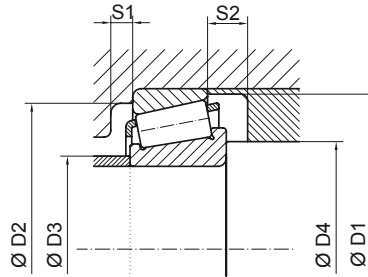

WEIGHT / PESO		ASSEMBLY / MONTAJE							LOAD / CARGA		LOAD FACTORS / FACTORES DE CARGA			SPEED / VELOCIDAD		REFERENCES / REFERENCIAS
		D1 min	D2 min	D2 max	D3 max	D4 min	S1	S2	Dynamic / Dinámica	Static / Estática	Dynamics / Dinámicos	Statics / Estáticos	Oil / Aceite	Grease / Grasa		
kg	lb	mm	mm	mm	mm	mm	mm	mm	C	Co	e	Y	Yo	na	ng	
0,28	0,61	68,5	65,5	67,5	49,5	52,5	4,0	3,5	52,0	64,3	0,35	1,71	0,94	6800	5000	18590/18520
0,33	0,72	69,5	64,5	69,5	48,5	52,5	4,0	4,5	60,4	75,4	0,40	1,50	0,82	6700	5000	LM 501349/LM 501310
0,35	0,76	69,5	63,5	69,5	48,5	52,5	4,0	4,5	60,4	75,4	0,40	1,50	0,82	6700	5000	LM 501349/LM 501314
0,33	0,73	71,0	64,5	70,5	50,0	44,5	4,0	3,5	50,3	62,5	0,48	1,23	0,67	6500	4800	11163/11300
0,33	0,72	71,0	64,5	70,5	50,0	46,5	4,0	3,5	50,3	62,5	0,48	1,23	0,67	6500	4800	11162/11300
0,42	0,92	71,5	65,5	72,5	49,0	44,5	4,0	4,5	71,0	88,9	0,39	1,52	0,84	6600	4900	24781/24720
0,42	0,92	71,5	65,5	72,5	49,0	52,5	4,0	4,5	71,0	88,9	0,39	1,52	0,84	6600	4900	24780/24720
0,46	1,01	71,5	63,5	68,0	49,0	44,5	4,0	4,5	71,0	88,9	0,39	1,52	0,84	6600	4900	24781/24721
0,46	1,01	71,5	63,5	68,0	49,0	52,5	4,0	4,5	71,0	88,9	0,39	1,52	0,84	6600	4900	24780/24721
0,52	1,15	73,6	68,0	75,0	50,0	46,5	4,5	4,5	83,9	107,4	0,32	1,88	1,03	6500	4800	26882 T/26822
0,51	1,13	73,6	68,0	75,0	50,0	52,5	4,5	4,5	83,9	107,4	0,32	1,88	1,03	6500	4800	26882/26822
0,45	0,99	75,0	71,5	75,0	50,5	44,5	5,5	3,0	74,6	83,2	0,27	2,20	1,21	6500	4800	336/332
0,52	1,14	75,0	71,0	75,0	50,5	52,5	2,5	10,5	74,6	83,2	0,27	2,20	1,21	6500	4800	342 A/332
0,55	1,21	73,5	67,0	69,0	50,0	52,5	4,0	4,5	83,9	107,4	0,32	1,88	1,03	6400	4800	26882/26820
0,63	1,38	75,0	68,5	69,0	48,0	44,5	5,5	5,5	104,9	125,1	0,27	2,20	1,21	6500	4800	3384/3320
0,63	1,39	78,0	66,5	71,5	49,0	52,5	4,0	6,0	90,7	121,2	0,55	1,10	0,60	6100	4500	M 802048/M 802011
0,74	1,62	79,5	73,0	73,0	53,0	52,5	4,5	6,0	102,3	128,3	0,31	1,96	1,08	6200	4600	3577/3520
0,78	1,72	80,5	70,5	74,5	50,5	52,5	4,0	6,0	111,7	141,1	0,40	1,49	0,82	6100	4500	3877/3820
0,81	1,79	79,5	73,0	76,5	53,0	46,5	4,5	6,0	102,3	128,3	0,31	1,96	1,08	6100	4500	3585/3525
0,81	1,79	79,5	73,0	76,5	53,0	52,5	4,5	6,0	102,3	128,3	0,31	1,96	1,08	6100	4500	3577/3525
0,66	1,45	84,0	69,0	83,0	51,0	49,0	4,0	7,5	81,9	92,7	0,78	0,77	0,42	5500	4100	44162/44348
0,82	1,80	78,5	73,0	82,5	49,5	52,5	5,5	4,5	111,6	129,6	0,26	2,27	1,25	6100	4500	419/414
0,91	2,00	84,0	70,0	78,0	54,5	44,5	4,0	7,0	103,5	139,7	0,54	1,10	0,60	5800	4300	HM 803145/HM 803110
0,88	1,93	84,0	70,0	78,0	54,0	52,5	4,0	7,0	103,5	139,7	0,54	1,10	0,60	5800	4300	HM 803146/HM 803110
1,18	2,60	84,0	74,0	79,5	52,5	45,0	4,5	6,0	141,3	186,9	0,28	2,11	1,16	6000	4400	4388/4335
1,02	2,24	86,5	77,0	82,5	55,0	52,5	4,0	6,0	123,0	149,6	0,36	1,66	0,92	5800	4300	49162/49368
1,06	2,33	90,0	76,0	84,0	58,0	52,5	4,0	7,0	112,7	152,0	0,55	1,10	0,60	5500	4100	HM 804840/HM804810
1,00	2,20	90,5	71,0	91,5	54,5	52,5	4,0	8,5	107,5	131,6	0,74	0,81	0,44	5300	3900	HM 903245/HM 903210
1,60	3,52	99,0	87,0	93,5	62,5	46,5	4,0	7,5	155,8	196,1	0,40	1,49	0,82	5300	3900	59162/59412
1,23	2,71	84,0	74,0	79,5	52,5	53,5	4,5	6,0	153,4	200,9	0,28	2,11	1,16	5900	4400	4395/4335
0,57	1,25	77,0	71,0	79,0	53,0	50,5	4,0	4,5	83,3	108,1	0,33	1,79	0,98	6200	4600	25578/25520
0,57	1,25	77,0	71,0	79,0	53,0	54,0	4,0	4,5	83,3	108,1	0,33	1,79	0,98	6200	4600	25576/25520

01.2

INCH SERIES SERIES PULGADAS

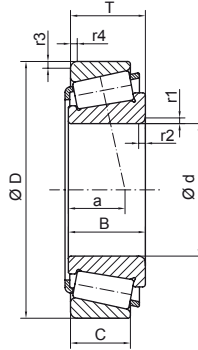

DIMENSIONS / DIMENSIONES													ISO REF / REF ISO	REFERENCES / REFERENCIAS
d		D		T		B		C		r1/r2 min	r3/r4 min	a		
mm	inch	mm	inch	mm	inch	mm	inch	mm	inch	mm	mm	mm		
42,862	1,688	82,931	3,265	26,988	1,063	25,400	1,000	22,225	0,875	2,3	2,3	20,4	25578/25523	
		83,058	3,270	23,812	0,938	25,400	1,000	19,050	0,750	2,3	3,2	17,4	25578/25521	
		83,058	3,270	23,876	0,940	25,400	1,000	19,114	0,753	2,3	2,0	17,2	25578/25522	
42,875	1,688	76,200	3,000	25,400	1,000	25,400	1,000	20,638	0,813	3,5	1,5	18,0	26884/26823	
		82,931	3,265	23,812	0,938	25,400	1,000	19,050	0,750	3,5	0,8	17,4	25577/25520	
		82,931	3,265	26,988	1,063	25,400	1,000	22,225	0,875	3,5	2,3	20,4	25577/25523	
		83,058	3,270	23,812	0,938	25,400	1,000	19,050	0,750	3,5	3,2	17,4	25577/25521	
		83,058	3,270	23,876	0,940	25,400	1,000	19,114	0,753	3,5	2,0	17,2	25577/25522	
44,450	1,750	82,931	3,265	23,813	0,938	25,400	1,000	19,050	0,750	0,5	0,8	17,4	25581/25520	
		82,931	3,265	23,812	0,938	25,400	1,000	19,050	0,750	3,5	0,8	17,4	25580/25520	
		82,931	3,265	26,988	1,063	25,400	1,000	22,225	0,875	3,5	2,3	20,4	25580/25523	
		83,058	3,270	23,812	0,938	25,400	1,000	19,050	0,750	3,5	3,2	17,4	25580/25521	
		83,058	3,270	23,876	0,940	25,400	1,000	19,114	0,753	3,5	2,0	17,2	25580/25522	
		84,138	3,313	30,162	1,188	30,866	1,215	23,812	0,938	3,5	3,3	19,9	3578/3520	
		85,000	3,347	20,638	0,813	21,692	0,854	17,463	0,688	2,3	1,5	15,9	355/354 X	
		85,000	3,347	20,638	0,813	21,692	0,854	17,463	0,688	3,5	1,5	15,9	355 X/354 X	
		87,312	3,438	30,162	1,188	30,866	1,215	23,812	0,938	3,5	3,3	19,9	3578/3525	
		88,900	3,500	30,162	1,188	29,370	1,156	23,020	0,906	3,5	3,3	25,5	HM 803149/HM 803110	
		90,119	3,548	23,000	0,906	21,692	0,854	21,808	0,859	3,5	2,3	18,2	355 X/352	
		92,075	3,625	30,162	1,188	29,370	1,156	23,020	0,906	3,5	3,3	25,5	HM 803149/HM 803112	
		93,264	3,672	30,162	1,188	30,302	1,193	23,812	0,938	3,5	3,3	22,1	3782/3720	
		93,662	3,688	31,750	1,250	31,750	1,250	25,400	1,000	3,5	3,3	22,3	49175/49368	
		95,250	3,750	27,783	1,094	28,575	1,125	22,225	0,875	0,8	0,8	20,0	33885/33822	
		95,250	3,750	30,162	1,188	29,370	1,156	23,020	0,906	3,5	3,3	25,8	HM 804843/HM 804810	
		95,250	3,750	30,958	1,219	28,301	1,114	20,638	0,813	1,2	0,8	30,6	53176/53375	
		95,250	3,750	30,958	1,219	28,301	1,114	20,638	0,813	2,0	2,3	30,6	53178/53377	
		95,250	3,750	30,958	1,219	28,301	1,114	20,638	0,813	3,5	0,8	30,6	53177/53375	
		95,250	3,750	30,958	1,219	28,575	1,125	22,225	0,875	3,5	0,8	31,4	HM 903249/HM 903210	
101,600	4,000	34,925	1,375	36,068	1,420	26,988	1,063	3,5	3,3	22,1	527/522			
104,775	4,125	36,512	1,438	36,512	1,438	28,575	1,125	3,5	3,3	28,8	HM 807040/HM 807010			
107,950	4,250	36,512	1,438	36,957	1,455	28,575	1,125	3,5	3,3	24,3	535/532 X			
111,125	4,375	30,162	1,188	26,909	1,059	20,638	0,813	3,5	3,3	37,1	55175 C/55437			

Assembly / Montaje

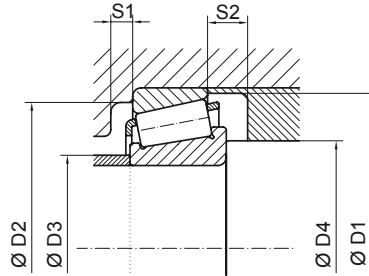

WEIGHT / PESO		ASSEMBLY / MONTAJE							LOAD / CARGA		LOAD FACTORS / FACTORES DE CARGA			SPEED / VELOCIDAD		REFERENCES / REFERENCIAS
		D1 min	D2 min	D2 max	D3 max	D4 min	S1	S2	Dynamic / Dinámica	Static / Estática	Dynamics / Dinámicos	Statics / Estáticos	Yo	Oil / Aceite	Grease / Grasa	
kg	lb	mm	mm	mm	mm	mm	mm	mm	C	Co	e	Y	Yo	na	ng	
0,61	1,35	77,0	69,5	75,0	53,0	50,5	4,0	4,5	83,3	108,1	0,33	1,79	0,98	6200	4600	25578/25523
0,57	1,25	77,0	71,0	72,0	53,0	50,5	4,0	4,5	83,3	108,1	0,33	1,79	0,98	6200	4600	25578/25521
0,57	1,26	77,0	71,0	76,0	53,0	50,5	4,0	4,5	83,3	108,1	0,33	1,79	0,98	6200	4600	25578/25522
0,46	1,01	73,5	67,5	70,5	49,8	54,0	4,0	4,5	83,9	107,4	0,32	1,88	1,03	6400	4800	26884/26823
0,57	1,25	77,0	71,0	79,0	53,0	54,0	4,0	4,5	83,3	108,1	0,33	1,79	0,98	6200	4600	25577/25520
0,61	1,35	77,0	69,5	75,0	53,0	54,0	4,0	4,5	83,3	108,1	0,33	1,79	0,98	6200	4600	25577/25523
0,57	1,25	77,0	71,0	72,0	53,0	54,0	4,0	4,5	83,3	108,1	0,33	1,79	0,98	6200	4600	25577/25521
0,57	1,26	77,0	71,0	76,0	53,0	54,0	4,0	4,5	83,3	108,1	0,33	1,79	0,98	6200	4600	25577/25522
0,55	1,21	77,0	71,0	79,0	53,0	47,0	4,0	4,5	83,3	108,1	0,33	1,79	0,98	6100	4500	25581/25520
0,55	1,20	77,0	71,0	79,0	53,0	56,0	4,0	4,5	83,3	108,1	0,33	1,79	0,98	6100	4500	25580/25520
0,59	1,30	77,0	69,5	75,0	53,0	56,0	4,0	4,5	83,3	108,1	0,33	1,79	0,98	6100	4500	25580/25523
0,55	1,21	77,0	71,0	72,0	53,0	56,0	4,0	4,5	83,3	108,1	0,33	1,79	0,98	6100	4500	25580/25521
0,55	1,21	77,0	71,0	76,0	53,0	56,0	4,0	4,5	83,3	108,1	0,33	1,79	0,98	6100	4500	25580/25522
0,68	1,50	79,5	73,0	73,0	53,0	56,0	4,5	6,0	102,3	128,3	0,31	1,96	1,08	6100	4500	3578/3520
0,50	1,10	80,0	75,5	79,5	55,0	47,0	4,5	3,0	85,0	101,0	0,30	1,96	1,07	6100	4500	355/354 X
0,51	1,12	80,0	75,5	79,5	54,5	56,0	4,5	3,0	85,0	101,0	0,30	1,96	1,07	6100	4500	355 X/354 X
0,76	1,67	79,5	73,0	76,5	53,0	56,0	4,5	6,0	102,3	128,3	0,31	1,96	1,08	5900	4400	3578/3525
0,86	1,89	84,0	70,0	78,0	54,0	56,0	4,0	7,0	103,5	139,7	0,54	1,10	0,60	5600	4200	HM 803149/HM 803110
0,67	1,47	81,0	74,5	82,0	54,5	56,0	4,0	1,0	85,0	101,0	0,30	1,96	1,07	5800	4300	355 X/352
0,95	2,09	84,0	70,0	81,0	54,0	56,0	4,5	7,0	103,5	139,7	0,54	1,10	0,60	5500	4100	HM 803149/HM 803112
0,94	2,07	88,0	80,0	82,0	60,5	56,0	4,5	6,0	110,4	146,6	0,33	1,77	0,97	5700	4200	3782/3720
1,02	2,24	86,5	77,0	82,5	55,5	56,0	4,5	6,0	122,9	149,7	0,36	1,66	0,92	5600	4200	49175/49368
0,94	2,07	90,0	83,0	91,5	61,5	47,5	4,5	5,5	116,9	153,7	0,33	1,82	1,00	5600	4100	33885/33822
1,02	2,24	90,0	76,0	84,0	58,0	56,0	4,5	7,0	112,8	151,9	0,55	1,10	0,60	5400	4000	HM 804843/HM 804810
0,90	1,98	89,5	72,0	91,5	53,5	49,0	4,5	10,0	97,0	108,3	0,74	0,81	0,44	5100	3800	53176/53375
0,89	1,96	89,5	72,0	87,0	53,5	51,5	4,5	10,0	97,0	108,3	0,74	0,81	0,44	5100	3800	53178/53377
0,89	1,96	89,5	72,0	91,5	54,0	56,0	4,5	10,0	97,0	108,2	0,74	0,81	0,44	5100	3800	53177/53375
0,95	2,10	90,5	71,0	91,5	54,5	56,0	4,5	8,5	107,5	131,6	0,74	0,81	0,44	5100	3800	HM 903249/HM 903210
1,34	2,94	94,0	86,5	90,5	61,0	56,0	5,5	7,5	149,1	184,0	0,28	2,10	1,15	5400	4000	527/522
1,58	3,47	99,5	84,5	93,6	60,0	56,0	4,5	7,5	153,2	212,0	0,49	1,23	0,68	5100	3800	HM 807040/HM 807010
1,66	3,65	98,0	89,0	97,0	64,5	56,0	5,5	7,5	156,0	197,7	0,29	2,02	1,11	5100	3800	535/532 X
1,46	3,21	103,5	82,0	100,0	65,0	56,0	4,5	9,5	120,9	163,2	0,88	0,68	0,37	4400	3300	55175 C/55437

01.2

INCH SERIES SERIES PULGADAS

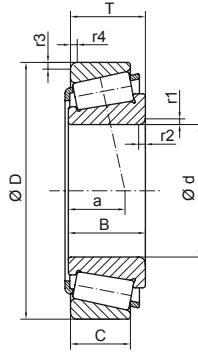

DIMENSIONS / DIMENSIONES													ISO REF / REF ISO	REFERENCES / REFERENCIAS
d		D		T		B		C		r1/r2 min	r3/r4 min	a		
mm	inch	mm	inch	mm	inch	mm	inch	mm	inch	mm	mm	mm		
44,988	1,771	82,931	3,265	23,812	0,937	25,400	1,000	19,050	0,750	1,5	0,8	17,4	25584/25520	
		83,058	3,270	23,813	0,938	25,400	1,000	19,050	0,750	1,5	3,2	17,4	25584/25521	
		83,284	3,672	30,182	1,188	30,302	1,193	23,812	0,938	3,5	3,3	22,1	3776/3720	
		89,995	3,937	25,400	1,000	25,400	1,000	20,638	0,813	1,5	0,5	20,6	25584/25547 RB	
		101,600	4,000	34,925	1,375	36,068	1,420	26,988	1,063	4,3	3,3	22,1	527 S/522	
44,987	1,771	82,931	3,265	23,812	0,938	25,400	1,000	19,050	0,750	3,5	0,8	17,4	25584 A/25520	
		104,986	4,133	32,512	1,280	31,750	1,250	23,368	0,920	2,5	2,5	34,0	HM 905843/HM 905810	
45,000	1,772	95,000	3,740	29,000	1,142	26,500	1,043	20,000	0,787	2,5	2,5	33,0	T7FC045 JW 4549/JW 4510	
		95,000	3,740	36,000	1,417	35,000	1,378	30,000	1,181	2,5	2,5	23,6	T2ED045 JF 4549/JF 4510	
45,230	1,781	79,985	3,149	19,842	0,781	20,638	0,813	15,080	0,594	2,0	1,3	16,1	17887/17831	
45,237	1,781	79,975	3,149	30,162	1,188	30,886	1,216	23,812	0,938	3,5	3,3	19,9	3586/3525	
45,242	1,781	73,431	2,891	19,558	0,770	19,812	0,780	15,748	0,620	3,5	0,8	14,9	LM 102949/LM 102910	
		73,431	2,891	21,430	0,844	19,812	0,780	17,620	0,694	3,5	0,8	16,5	LM 102949/LM 102911	
		77,788	3,063	19,842	0,781	19,842	0,781	15,080	0,594	3,5	0,8	17,3	LM 603049/LM 603011	
		77,788	3,063	21,430	0,844	19,842	0,781	16,667	0,656	3,5	0,8	17,3	LM 603049/LM 603012	
		79,975	3,149	19,842	0,781	19,842	0,781	15,080	0,594	3,5	0,8	17,3	LM 603049/LM 603014	
45,618	1,796	82,931	3,265	23,812	0,938	25,400	1,000	19,050	0,750	3,5	0,8	17,4	25590/25520	
		82,931	3,265	26,988	1,063	25,400	1,000	22,225	0,875	3,5	2,3	20,4	25590/25523	
		83,058	3,270	23,812	0,938	25,400	1,000	19,050	0,750	3,5	3,2	17,4	25590/25521	
		83,058	3,270	23,876	0,940	25,400	1,000	19,114	0,753	3,5	2,0	17,2	25590/25522	
45,987	1,811	74,976	2,952	18,000	0,709	18,000	0,709	14,000	0,551	2,3	1,5	15,8	LM 503349/LM 503310	
		74,976	2,952	18,000	0,709	18,000	0,709	14,000	0,551	ESP	1,5	15,8	LM 503349 A/LM 503310	
46,038	1,813	79,375	3,125	17,462	0,688	17,462	0,688	13,495	0,531	2,8	1,5	15,5	18690/18620	
		85,000	3,347	20,638	0,813	21,692	0,854	17,463	0,688	2,3	1,5	15,9	359 S/354 X	
		85,000	3,347	20,638	0,813	21,692	0,854	17,463	0,688	3,5	1,5	15,9	359 A/354 X	
47,625	1,875	88,900	3,500	20,638	0,813	22,225	0,875	16,513	0,650	2,3	1,3	16,5	369 S/362 A	
		88,900	3,500	20,638	0,813	22,225	0,875	16,513	0,650	3,5	1,3	16,5	369 A/362 A	
		88,900	3,500	25,400	1,000	25,400	1,000	19,050	0,750	0,8	3,3	23,6	M 804048/M 804010	
		88,900	3,500	25,400	1,000	25,400	1,000	19,050	0,750	3,5	3,3	23,5	M 804049/M 804010	
		90,000	3,543	20,000	0,787	22,225	0,875	15,875	0,625	2,3	2,0	15,9	369 S/362	
		90,000	3,543	20,000	0,787	22,225	0,875	20,000	0,787	2,3	0,8	15,9	369 S/363	
		90,000	3,543	20,000	0,787	22,225	0,875	20,000	0,787	3,5	0,8	15,9	369 A/363	

Assembly / Montaje

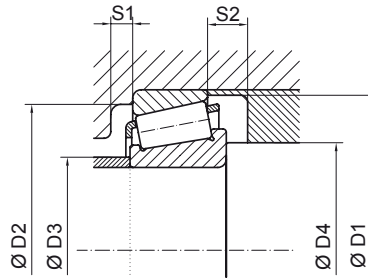

WEIGHT / PESO		ASSEMBLY / MONTAJE							LOAD / CARGA		LOAD FACTORS / FACTORES DE CARGA			SPEED / VELOCIDAD		REFERENCES / REFERENCIAS
		D1 min	D2 min	D2 max	D3 max	D4 min	S1	S2	Dynamic / Dinámica	Static / Estática	Dynamics / Dinámicos	Statics / Estáticos	Oil / Aceite	Grease / Grasa		
kg	lb	mm	mm	mm	mm	mm	mm	mm	kN	kN	e	Y	Yo	na	ng	
0,56	1,22	76,5	71,0	79,5	53,0	50,5	9,0	4,5	83,3	108,1	0,33	1,79	0,98	6100	4500	25584/25520
0,56	1,22	77,0	71,0	72,0	53,0	50,5	4,5	4,5	83,3	108,1	0,33	1,79	0,98	6100	4500	25584/25521
0,93	2,05	88,0	80,0	82,0	60,5	56,5	4,5	6,0	110,4	146,6	0,33	1,77	0,97	5600	4200	3776/3720
1,04	2,28	76,5	70,5	97,5	53,0	50,5	4,5	4,5	83,3	108,1	0,33	1,79	0,98	5400	4000	25584/25547 RB
1,33	2,92	94,0	86,5	90,5	61,0	58,5	5,5	7,5	149,1	184,0	0,28	2,10	1,15	5400	4000	527 S/522
0,54	1,18	77,0	71,0	79,0	53,0	56,5	4,5	4,5	83,3	108,1	0,33	1,79	0,98	6100	4500	25584 A/25520
1,36	3,00	99,5	78,0	96,0	61,0	53,5	4,5	9,0	122,4	166,6	0,78	0,76	0,42	4700	3500	HM 905843/HM 905810
0,90	1,97	91,0	71,0	86,5	51,0	53,5	4,5	9,0	94,6	116,7	0,87	0,69	0,38	4900	3700	JW 4549/JW 4510
1,20	2,64	89,5	79,5	86,0	54,0	53,5	4,5	6,0	160,9	203,8	0,32	1,86	1,02	5600	4100	JF 4549/JF 4510
0,40	0,88	74,5	70,0	75,0	53,0	52,0	4,5	4,5	66,2	84,9	0,36	1,64	0,90	6200	4600	17887/17831
0,76	1,66	80,0	73,0	76,0	53,0	56,5	4,0	6,0	102,3	128,3	0,31	1,96	1,08	5900	4400	3586/3525
0,30	0,66	70,0	66,0	69,0	52,0	56,5	4,5	3,5	57,4	80,8	0,30	1,96	1,07	6600	4900	LM 102949/LM 102910
0,32	0,70	70,0	65,5	70,0	52,0	56,5	4,5	3,5	57,3	80,8	0,30	1,96	1,07	6600	4900	LM 102949/LM 102911
0,36	0,79	74,0	68,0	74,0	53,0	56,5	4,5	4,5	61,9	79,7	0,42	1,40	0,77	6300	4600	LM 603049/LM 603011
0,38	0,83	74,0	67,0	74,0	53,0	56,5	4,5	4,5	61,9	79,7	0,42	1,40	0,77	6300	4600	LM 603049/LM 603012
0,39	0,86	74,0	68,0	76,5	53,0	56,5	4,5	4,5	61,9	79,7	0,42	1,40	0,77	6100	4600	LM 603049/LM 603014
0,53	1,16	77,0	71,0	79,0	53,0	57,0	4,5	4,5	83,3	108,1	0,33	1,79	0,98	6100	4500	25590/25520
0,58	1,27	77,0	69,5	75,0	53,0	57,0	4,5	4,5	83,3	108,1	0,33	1,79	0,98	6100	4500	25590/25523
0,53	1,17	77,0	71,0	72,0	53,0	57,0	4,5	4,5	83,3	108,1	0,33	1,79	0,98	6100	4500	25590/25521
0,53	1,17	77,0	71,0	76,0	53,0	57,0	4,5	4,5	83,3	108,1	0,33	1,79	0,98	6100	4500	25590/25522
0,30	0,65	71,5	67,0	69,0	53,5	53,5	4,5	4,0	57,5	81,3	0,40	1,49	0,82	6400	4700	LM 503349/LM 503310
0,30	0,65	71,5	67,0	69,0	53,5	59,0	4,5	4,0	57,5	81,3	0,40	1,49	0,82	6400	4700	LM 503349 A/LM 503310
0,33	0,72	73,5	69,5	73,5	54,0	55,0	4,5	3,5	51,4	64,7	0,37	1,60	0,88	6200	4600	18690/18620
0,49	1,08	80,0	75,5	79,5	54,5	53,5	5,5	3,0	85,0	101,0	0,30	1,96	1,07	6000	4400	359 S/354 X
0,49	1,08	80,0	75,5	79,5	54,5	57,5	5,5	3,0	85,0	101,0	0,30	1,96	1,07	6000	4400	359 A/354 X
0,53	1,17	83,5	79,0	84,0	57,5	55,5	5,5	4,0	81,0	96,1	0,32	1,87	1,03	5700	4200	369 S/362 A
0,53	1,17	83,5	79,0	84,0	57,5	59,0	5,0	4,0	81,0	96,1	0,32	1,87	1,03	5700	4200	369 A/362 A
0,65	1,42	85,0	74,0	78,0	55,5	51,0	5,0	6,0	89,7	112,8	0,55	1,10	0,60	5500	4100	M 804048/M 804010
0,66	1,45	85,0	74,0	78,0	55,5	59,0	5,0	6,0	89,5	111,5	0,55	1,10	0,60	5500	4100	M 804049/M 804010
0,53	1,17	85,0	79,5	83,0	57,5	55,5	5,0	4,0	81,0	96,1	0,32	1,87	1,03	5700	4200	369 S/362
0,57	1,25	85,0	79,5	86,5	57,5	55,5	5,5	4,0	81,0	96,1	0,32	1,87	1,03	5700	4200	369 S/363
0,57	1,25	85,0	79,5	86,5	57,5	59,0	5,5	4,0	81,0	96,1	0,32	1,87	1,03	5700	4200	369 A/363

01.2

INCH SERIES SERIES PULGADAS

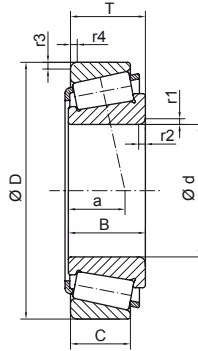

DIMENSIONS / DIMENSIONES												ISO REF / REF ISO	REFERENCES / REFERENCIAS	
d		D		T		B		C		r1/r2 min	r3/r4 min			a
mm	inch	mm	inch	mm	inch	mm	inch	mm	inch	mm	mm	mm		
47,625	1,875	93,264	3,672	30,162	1,188	30,302	1,193	23,812	0,938	3,5	3,3	22,1		3779/3720
		93,264	3,672	30,162	1,188	30,302	1,193	23,812	0,938	6,4	3,3	22,1		3778/3720
		95,250	3,750	30,162	1,188	29,370	1,156	23,020	0,906	3,5	3,3	25,9		HM 804846/HM 804810
		96,838	3,813	21,000	0,827	21,946	0,864	15,875	0,625	0,8	0,8	17,6		386 A/382 A
		101,600	4,000	34,925	1,375	36,068	1,420	26,988	1,063	3,5	3,3	22,1		528/522
		107,950	4,250	36,512	1,438	36,957	1,455	28,575	1,125	3,5	3,3	24,3		536/532 X
		111,125	4,375	30,162	1,188	26,909	1,059	20,638	0,813	3,5	3,3	37,0		55187 C/55437
123,825	4,875	36,512	1,438	32,791	1,291	25,400	1,000	3,5	3,3	38,2		72187/72487		
49,212	1,938	103,188	4,063	43,658	1,719	44,475	1,751	36,512	1,438	3,5	3,3	27,4		5395/5335
		104,775	4,125	36,512	1,438	36,512	1,438	28,575	1,125	3,5	3,3	28,8		HM 807044/HM 807010
49,987	1,968	89,980	3,543	24,750	0,974	25,400	1,000	19,987	0,787	2,3	2,3	19,9		28579/28520
50,000	1,969	82,000	3,228	21,500	0,847	21,500	0,847	17,000	0,669	3,0	0,5	16,3	T2CC050	JLM 104948/JLM 104910
		82,000	3,228	21,500	0,847	23,993	0,945	17,000	0,669	3,5	0,5	15,9		JLM 104946/JLM 104910
		82,000	3,228	21,500	0,847	27,700	1,091	17,000	0,669	3,0	0,5	16,3		JLM 104945/JLM 104910
		82,550	3,250	21,500	0,847	21,500	0,847	16,510	0,650	3,0	1,3	16,3		JLM 104948/LM 104911
		84,000	3,307	22,000	0,866	22,000	0,866	17,500	0,689	3,5	1,5	19,7	T4CC050	JLM 704649/JLM 704610
		90,000	3,543	28,000	1,102	28,000	1,102	23,000	0,906	3,0	2,5	20,6	T2DD050	JM 205149/JM 205110
		90,000	3,543	28,000	1,102	28,000	1,102	23,000	0,906	5,0	2,5	20,6		JM 205149 A/JM 205110
		100,000	3,937	36,000	1,417	35,000	1,378	30,000	1,181	2,5	2,5	24,5	T2ED050	JF 5049/JF 5010
		105,000	4,134	32,000	1,260	29,000	1,142	22,000	0,866	3,0	3,0	36,0	T7FC050	JW 5049/JW 5010
		105,000	4,134	37,000	1,457	36,000	1,417	29,000	1,142	3,0	2,5	29,5	T4FD050	JHM 807045/JHM 807012
50,800	2,000	82,000	3,228	21,976	0,865	22,225	0,875	17,000	0,669	3,5	0,5	16,2		LM 104949/JLM 104910
		82,550	3,250	21,590	0,850	22,225	0,875	16,510	0,650	3,5	1,3	15,9		LM 104949/LM 104911
		82,550	3,250	21,976	0,865	22,225	0,875	18,542	0,730	3,5	0,8	16,2		LM 104949/LM 104911 A
		82,931	3,265	21,590	0,850	22,225	0,875	16,510	0,650	3,5	1,3	15,9		LM 104949/LM 104912
		85,000	3,347	17,462	0,688	17,462	0,688	13,495	0,531	3,5	1,5	16,8		18790/18720
		88,900	3,500	20,638	0,813	22,225	0,875	16,513	0,650	1,5	1,3	16,5		368/362 A
		88,900	3,500	20,638	0,813	22,225	0,875	16,513	0,650	3,5	1,3	16,5		368 A/362 A
		89,980	3,543	24,750	0,974	25,400	1,000	19,987	0,787	3,5	2,3	19,9		28580/28520
		90,000	3,543	25,000	0,984	22,225	0,875	20,000	0,787	3,5	2,0	20,6		368 A/362 X
92,075	3,625	24,608	0,969	25,400	1,000	19,845	0,781	3,5	0,8	19,8		28580/28521		
93,264	3,672	30,162	1,188	30,302	1,193	23,812	0,938	3,5	3,3	22,1		3780/3720		

Assembly / Montaje

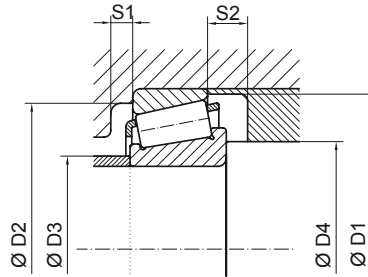

WEIGHT / PESO		ASSEMBLY / MONTAJE							LOAD / CARGA		LOAD FACTORS / FACTORES DE CARGA			SPEED / VELOCIDAD		REFERENCES / REFERENCIAS
		D1 min	D2 min	D2 max	D3 max	D4 min	S1	S2	Dynamic / Dinámica	Static / Estática	Dynamics / Dinámicos	Statics / Estáticos	Oil / Aceite	Grease / Grasa		
kg	lb	mm	mm	mm	mm	mm	mm	mm	C	Co	e	Y	Yo	na	ng	
0,90	1,97	88,0	80,0	82,0	60,5	59,0	5,0	6,0	110,4	146,6	0,33	1,77	0,97	5500	4100	3779/3720
0,89	1,95	88,0	80,0	82,0	60,5	67,5	5,0	6,0	110,4	146,6	0,33	1,77	0,97	5500	4100	3778/3720
0,96	2,11	90,0	76,0	84,0	58,0	59,0	5,0	7,0	112,8	151,9	0,55	1,10	0,60	5400	4000	HM 804846/HM 804810
0,72	1,59	91,5	86,5	93,0	66,0	51,0	5,5	5,0	86,9	108,8	0,35	1,69	0,93	5400	4000	386 A/382 A
1,27	2,80	94,0	86,5	90,5	61,0	59,0	6,0	7,5	149,1	184,0	0,28	2,10	1,15	5300	3900	528/522
1,57	3,45	98,0	89,0	97,0	64,5	59,0	5,0	7,5	156,0	197,7	0,29	2,02	1,11	5000	3700	536/532 X
1,39	3,05	103,5	82,0	100,0	65,5	59,0	5,0	9,5	120,9	163,2	0,88	0,68	0,37	4300	3200	55187 C/55437
2,00	4,40	114,5	92,0	112,5	67,0	59,0	5,0	11,0	157,3	179,1	0,73	0,81	0,44	4200	3100	72187/72487
1,75	3,84	96,0	84,5	92,0	60,5	60,5	5,0	7,0	182,2	246,2	0,30	2,02	1,11	5100	3800	5395/5335
1,48	3,25	99,5	84,5	93,6	60,0	60,5	5,0	7,5	153,2	212,0	0,49	1,23	0,68	4900	3700	HM 807044/HM 807010
0,65	1,43	86,0	79,0	82,0	61,5	57,5	5,0	4,5	91,9	127,8	0,37	1,59	0,87	5500	4100	28579/28520
0,41	0,90	78,0	74,0	79,0	57,0	60,0	5,5	4,5	76,4	103,7	0,30	1,97	1,08	5900	4400	JLM 104948/JLM 104910
0,43	0,94	78,0	74,0	79,0	57,5	61,5	5,5	4,5	75,6	102,5	0,31	1,97	1,08	5900	4400	JLM 104946/JLM 104910
0,44	0,97	78,0	74,0	79,0	57,0	60,0	5,5	4,5	76,4	103,7	0,30	1,97	1,08	5900	4400	JLM 104945/JLM 104910
0,42	0,92	78,0	74,0	77,5	57,0	60,0	5,5	4,5	76,4	103,7	0,30	1,97	1,08	5900	4400	JLM 104948/LM 104911
0,46	1,01	80,0	73,0	78,5	57,0	61,5	5,0	4,5	74,8	102,0	0,44	1,37	0,75	5700	4200	JLM 704649/JLM 704610
0,72	1,58	85,6	78,5	79,5	57,5	59,0	5,0	5,0	110,6	146,0	0,33	1,82	1,00	5600	4100	JM 205149/JM 205110
0,71	1,56	85,6	78,5	79,5	58,0	66,0	5,0	5,0	110,6	145,9	0,33	1,82	1,00	5600	4100	JM 205149 A/JM 205110
1,29	2,84	94,5	83,5	91,0	58,5	58,5	5,0	6,0	167,8	219,0	0,34	1,75	0,96	5200	3900	JF 5049/JF 5010
1,21	2,66	100,5	78,0	95,0	59,0	60,0	5,0	10,0	122,6	157,5	0,87	0,69	0,38	4500	3300	JW 5049/JW 5010
1,53	3,36	99,5	84,0	96,3	60,0	60,0	5,0	8,0	153,2	212,0	0,49	1,23	0,68	4900	3600	JHM 807045/JHM 807012
0,41	0,89	78,5	74,5	79,5	57,0	62,0	5,5	4,5	76,4	103,7	0,30	1,97	1,08	5900	4400	LM 104948/JLM 104910
0,41	0,90	78,0	74,0	77,5	57,0	62,0	5,5	5,0	76,4	103,7	0,30	1,97	1,08	5900	4400	LM 104949/LM 104911
0,44	0,97	78,0	73,5	79,0	57,0	62,0	5,5	3,0	75,6	102,5	0,31	1,97	1,08	5900	4400	LM 104949/LM 104911 A
0,42	0,92	78,0	74,0	77,5	57,0	62,0	5,5	5,0	76,4	103,7	0,30	1,97	1,08	5900	4300	LM 104949/LM 104912
0,36	0,80	79,0	74,5	79,0	59,5	62,0	5,0	3,5	54,3	71,6	0,40	1,48	0,81	5700	4200	18790/18720
0,50	1,10	83,5	79,0	84,0	58,0	56,0	5,0	4,0	81,0	96,1	0,32	1,87	1,03	5600	4100	368/362 A
0,49	1,08	83,5	79,0	84,0	57,5	62,0	5,5	4,0	81,0	96,1	0,32	1,87	1,03	5600	4100	368 A/362 A
0,64	1,41	86,0	79,0	82,0	61,5	62,0	5,0	4,5	91,9	127,8	0,37	1,59	0,87	5500	4100	28580/28520
0,57	1,25	83,0	77,0	83,0	57,5	62,0	4,0	5,0	81,0	96,1	0,32	1,87	1,03	5600	4100	368 A/362 X
0,68	1,50	86,0	79,0	88,5	61,5	62,0	4,5	4,5	91,9	127,8	0,37	1,59	0,87	5400	4000	28580/28521
0,83	1,82	88,0	80,0	82,0	60,5	62,0	4,5	6,0	110,4	146,6	0,33	1,77	0,97	5400	4000	3780/3720

01.2

INCH SERIES SERIES PULGADAS

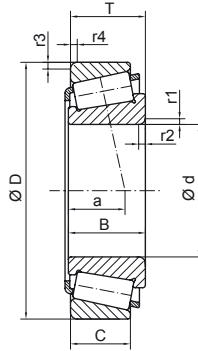

DIMENSIONS / DIMENSIONES												ISO REF / REF ISO	REFERENCIAS / REFERENCIAS
d		D		T		B		C		r1/r2 min	r3/r4 min		
mm	inch	mm	inch	mm	inch	mm	inch	mm	inch	mm	mm	mm	
50,800	2,000	93,264	3,672	30,162	1,188	30,302	1,193	23,812	0,938	6,4	3,3	22,1	3784/3720
		93,662	3,688	30,162	1,188	30,302	1,193	23,812	0,938	3,5	3,3	22,1	3780/3727
		93,662	3,688	30,162	1,188	30,302	1,193	23,812	0,938	6,4	3,3	22,1	3784/3727
		95,250	3,750	27,783	1,094	28,575	1,125	22,225	0,875	3,5	0,8	20,0	33889/33822
		95,250	3,750	27,783	1,094	28,575	1,125	22,225	0,875	3,5	2,3	20,0	33889/33821
		96,838	3,813	21,000	0,827	21,946	0,864	15,875	0,625	2,3	0,8	17,6	385 A/382 A
		98,425	3,875	21,000	0,827	21,946	0,864	17,825	0,702	2,3	0,8	17,6	385 A/382
		99,995	3,937	24,607	0,969	25,400	1,000	19,845	0,781	3,5	0,5	19,8	28580/28527 RB
		100,000	3,937	34,925	1,375	36,068	1,420	26,988	1,063	0,8	0,6	22,1	529/520 X1
		101,600	4,000	31,750	1,250	31,750	1,250	25,400	1,000	3,5	3,3	24,4	49585/49520
		101,600	4,000	34,925	1,375	36,068	1,420	26,988	1,063	0,8	3,3	22,1	529/522
		101,600	4,000	34,925	1,375	36,068	1,420	26,988	1,063	3,5	3,3	22,1	529 X/522
		104,775	4,125	30,162	1,188	29,317	1,154	24,605	0,969	0,8	3,3	24,1	455/453 X
		104,775	4,125	30,162	1,188	30,958	1,219	23,812	0,938	0,8	0,8	22,2	45285 A/45221
104,775	4,125	30,162	1,188	30,958	1,219	23,812	0,938	6,4	3,3	22,1	45284/45220		
104,775	4,125	30,162	1,187	30,958	1,219	23,812	0,937	0,8	3,3	22,2	45285 A/45220		
104,775	4,125	36,512	1,438	36,512	1,438	28,575	1,125	3,5	3,3	29,1	HM 807046/HM 807010		
104,775	4,125	39,687	1,562	40,157	1,581	33,338	1,313	3,5	3,3	27,3	4580/4535		
107,950	4,250	36,512	1,438	36,957	1,455	28,575	1,125	3,5	3,3	24,3	537/532 X		
111,125	4,375	30,162	1,188	26,909	1,059	20,638	0,813	3,5	3,3	37,0	55200 C/55437		
111,125	4,375	38,100	1,500	36,957	1,455	33,338	1,313	3,5	3,3	26,0	537/532		
120,650	4,750	41,275	1,625	41,275	1,625	31,750	1,250	3,5	3,3	27,3	619/612		
123,825	4,875	36,512	1,438	32,791	1,291	25,400	1,000	3,5	3,3	38,0	72200 C/72487		
51,592	2,031	88,900	3,500	20,638	0,813	22,225	0,875	16,513	0,650	2,0	1,3	16,5	368 S/362 A
		90,000	3,543	20,000	0,787	22,225	0,875	15,875	0,625	2,0	2,0	15,9	368 S/362
52,388	2,063	92,075	3,625	24,608	0,969	25,400	1,000	19,845	0,781	3,5	0,8	19,8	28584/28521
		93,264	3,672	30,162	1,188	30,302	1,193	23,812	0,938	2,3	3,3	22,1	3767/3720
		95,250	3,750	27,783	1,094	28,575	1,125	22,225	0,875	3,5	2,3	20,0	33891/33821
		111,125	4,375	30,162	1,188	26,909	1,059	20,638	0,813	3,5	3,3	37,1	55206 C/55437
53,975	2,125	88,900	3,500	19,050	0,750	19,050	0,750	13,492	0,531	2,3	2,0	20,7	LM 806649/LM 806610
		95,250	3,750	27,783	1,094	28,575	1,125	22,225	0,875	1,5	0,8	20,0	33895/33822
		95,250	3,750	27,783	1,094	28,575	1,125	22,225	0,875	1,5	2,3	20,0	33895/33821

Assembly / Montaje

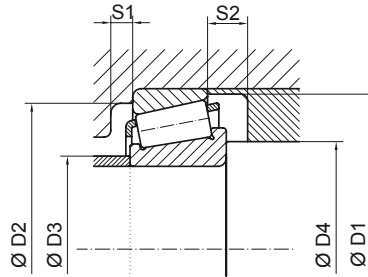

WEIGHT / PESO		ASSEMBLY / MONTAJE							LOAD / CARGA		LOAD FACTORS / FACTORES DE CARGA			SPEED / VELOCIDAD		REFERENCES / REFERENCIAS
		D1 min	D2 min	D2 max	D3 max	D4 min	S1	S2	Dynamic / Dinámica	Static / Estática	Dynamics / Dinámicos	Statics / Estáticos	Oil / Aceite	Grease / Grasa		
kg	lb	mm	mm	mm	mm	mm	mm	mm	C	Co	e	Y	Yo	na	ng	
0,83	1,82	88,0	80,0	82,0	60,5	71,0	4,5	6,0	110,4	146,6	0,33	1,77	0,97	5400	4000	3784/3720
0,84	1,85	88,0	80,0	82,5	60,5	62,0	4,5	6,0	110,4	146,6	0,33	1,77	0,97	5400	4000	3780/3727
0,84	1,85	88,0	80,0	82,5	60,5	71,0	4,5	6,0	110,4	146,6	0,33	1,77	0,97	5400	4000	3784/3727
0,83	1,83	90,0	83,0	91,5	61,5	62,0	4,5	5,5	116,9	153,7	0,33	1,82	1,00	5300	4000	33889/33822
0,84	1,85	90,0	83,0	87,0	61,5	62,0	4,5	5,5	116,9	153,7	0,33	1,82	0,93	5300	4000	33889/33821
0,66	1,45	91,5	86,5	93,0	66,0	58,5	5,5	5,0	86,9	108,8	0,35	1,69	0,93	5300	3900	385 A/382 A
0,71	1,55	92,5	86,5	95,0	66,0	58,5	6,0	3,0	86,9	108,8	0,35	1,69	0,93	5200	3900	385 A/382
0,88	1,93	86,0	79,0	97,5	61,5	62,0	4,5	4,5	91,8	127,8	0,37	1,59	0,87	5400	4000	28580/28527 RB
1,15	2,54	94,0	86,5	97,0	61,0	54,0	5,5	7,5	149,0	184,0	0,28	2,10	1,15	5200	3900	529/520 X1
1,10	2,42	96,0	85,0	90,5	63,5	62,0	5,5	6,0	121,9	152,2	0,40	1,49	0,82	5100	3800	49585/49520
1,20	2,64	94,0	86,5	90,5	61,0	54,0	6,0	7,5	149,1	184,0	0,28	2,10	1,15	5200	3800	529/522
1,20	2,64	94,0	86,5	90,5	61,0	62,0	6,0	7,5	149,1	184,0	0,28	2,10	1,15	5200	3800	529 X/522
1,15	2,53	98,5	90,0	93,5	68,0	54,0	3,5	5,5	124,3	160,6	0,33	1,79	0,98	5000	3700	455/453 X
1,21	2,67	98,5	90,5	101,0	67,5	54,0	4,5	6,0	139,4	182,3	0,33	1,80	0,99	5000	3700	45285 A/45221
1,21	2,66	98,5	91,0	93,5	67,5	71,0	4,5	6,0	139,4	182,5	0,33	1,80	0,99	5000	3700	45284/45220
1,21	2,66	98,5	91,0	93,5	67,5	54,0	4,5	6,5	139,4	182,5	0,33	1,80	0,99	5000	3700	45285 A/45220
1,47	3,24	99,5	84,5	93,6	60,0	62,0	4,5	7,5	153,2	212,0	0,49	1,23	0,68	4900	3600	HM 807046/HM 807010
1,65	3,63	98,0	96,0	94,0	64,5	62,0	6,0	6,0	172,2	247,2	0,34	1,79	0,98	5000	3700	4580/4535
1,50	3,29	98,0	89,0	97,0	64,5	62,0	5,0	7,5	156,1	197,8	0,29	2,02	1,11	4900	3700	537/532 X
1,36	2,98	103,5	82,0	100,0	65,0	62,0	4,5	9,5	120,9	163,2	0,88	0,68	0,37	4300	3200	55200 C/55437
1,73	3,81	99,0	88,5	100,0	64,5	62,0	5,0	4,5	156,1	197,8	0,29	2,02	1,11	4800	3600	537/532
2,27	4,99	108,0	97,0	109,5	68,5	62,0	4,5	9,5	186,2	232,2	0,31	1,91	1,05	4600	3400	619/612
2,14	4,71	114,5	92,0	112,5	68,0	62,0	4,5	11,0	171,1	203,1	0,74	0,81	0,45	4100	3000	72200 C/72487
0,45	0,99	83,5	79,0	84,0	58,0	58,5	4,5	4,0	81,0	96,1	0,32	1,87	1,03	5600	4100	368 S/362 A
0,45	0,99	83,5	79,5	83,0	68,0	58,5	4,5	4,0	81,0	96,1	0,32	1,87	1,03	5500	4100	368 S/362
0,63	1,39	86,0	79,0	88,5	61,5	63,5	4,5	4,5	91,8	127,8	0,37	1,59	0,87	5400	4000	28584/28521
0,80	1,76	88,0	80,0	82,0	60,5	60,0	4,5	6,0	110,4	146,6	0,33	1,77	0,97	5400	4000	3767/3720
0,81	1,77	90,0	83,0	87,0	61,5	63,5	4,5	5,5	116,9	153,8	0,33	1,82	1,00	5300	3900	33891/33821
0,86	1,89	103,5	82,0	100,0	65,0	63,5	3,0	9,5	120,9	163,2	0,88	0,68	0,37	4200	3100	55206 C/55437
0,43	0,94	84,5	77,5	81,5	61,0	61,5	4,5	5,5	65,7	89,2	0,55	1,10	0,60	5300	3900	LM 806649/LM 806610
0,78	1,71	90,0	83,0	91,5	61,5	59,5	4,5	5,5	116,9	153,7	0,33	1,82	1,00	5200	3900	33895/33822
0,78	1,71	90,0	83,0	87,0	61,5	59,5	4,5	5,5	116,9	153,7	0,33	1,82	1,00	5200	3900	33895/33821

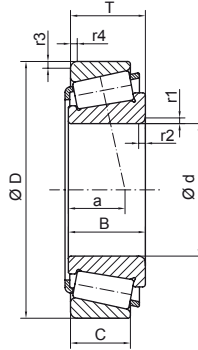

DIMENSIONS / DIMENSIONES												ISO REF / REF ISO	REFERENCES / REFERENCIAS	
d		D		T		B		C		r1/r2 min	r3/r4 min			a
mm	inch	mm	inch	mm	inch	mm	inch	mm	inch	mm	mm	mm		
53,975	2,125	96,838	3,813	21,000	0,827	21,946	0,864	15,875	0,625	0,8	0,8	17,6		389 A/382 A
		98,425	3,875	21,000	0,827	21,946	0,864	17,825	0,702	1,5	0,8	17,6		389 AS/382
		100,000	3,937	21,000	0,827	21,946	0,864	17,825	0,702	0,8	2,0	17,6		389 A/383 A
		104,775	4,125	36,512	1,438	36,512	1,438	28,575	1,125	3,5	3,3	28,8		HM 807049/HM 807010
		107,950	4,250	36,512	1,438	36,957	1,455	28,575	1,125	3,5	3,3	24,3		539/532 X
		111,125	4,375	38,100	1,500	36,957	1,455	30,162	1,188	3,5	3,3	26,0		539/532 A
		123,825	4,875	36,512	1,438	32,791	1,291	25,400	1,000	3,5	3,3	38,2		72212/72487
		127,000	5,000	50,800	2,000	52,388	2,063	41,275	1,625	3,5	3,3	31,3		6280/6220
54,487	2,145	104,775	4,125	36,512	1,438	36,512	1,438	28,575	1,125	3,5	3,3	28,8		HM 807048/HM 807010
54,988	2,165	111,125	4,375	38,100	1,500	36,957	1,455	33,338	1,313	0,8	3,3	26,0		538/532
55,000	2,165	90,000	3,543	23,000	0,906	23,000	0,906	18,500	0,728	1,5	0,5	20,3	T3CB055	JLM 506849/JLM 506810
		90,000	3,543	25,000	0,984	23,000	0,906	20,500	0,807	3,5	0,5	22,3		JLM 506849 A/JLM 506811
		95,000	3,740	29,000	1,142	29,000	1,142	23,500	0,925	1,5	2,5	21,3	T2DD055	JM 207049/JM 207010
		95,000	3,740	29,000	1,142	29,000	1,142	23,500	0,925	6,0	2,5	21,3	T2DD055A	JM 207049 A/JM 207010
		96,838	3,813	21,000	0,827	21,946	0,864	15,875	0,625	2,3	0,8	17,6		385/382 A
		98,425	3,875	21,000	0,827	21,946	0,864	17,825	0,702	2,3	0,8	17,6		385/382
		115,000	4,528	34,000	1,339	31,000	1,221	23,500	0,925	3,0	3,0	40,0	T7FC055	JW 5549/JW5510
55,562	2,188	122,238	4,813	43,658	1,719	43,764	1,723	36,513	1,438	1,2	3,3	30,5		5566/5535
		127,000	5,000	36,512	1,438	36,512	1,438	26,988	1,063	3,5	1,5	32,3		HM 813840/HM813811
57,150	2,250	96,838	3,813	21,000	0,827	21,946	0,864	15,875	0,625	2,3	0,8	17,6		387/382 A
		96,838	3,813	21,000	0,827	21,946	0,864	15,875	0,625	3,5	0,8	17,6		387 A/382 A
		96,838	3,813	21,000	0,827	21,946	0,864	15,875	0,625	5,0	0,8	17,6		387 AS/382 A
		96,838	3,813	24,608	0,969	24,608	0,969	19,446	0,766	3,5	0,8	21,1		28682/28621
		96,838	3,813	25,400	1,000	21,946	0,864	20,275	0,798	0,8	2,3	22,0		387 S/382 S
		96,838	3,813	25,400	1,000	21,946	0,864	20,275	0,798	2,3	2,3	22,0		387/382 S
		96,838	3,813	25,400	1,000	21,946	0,864	20,275	0,798	3,5	2,3	22,0		387 A/382 S
		96,838	3,813	25,400	1,000	21,946	0,864	20,275	0,798	5,0	2,3	22,0		387 AS/382 S
		97,630	3,844	24,608	0,969	24,608	0,969	19,446	0,766	3,5	0,8	21,1		28682/28622
		98,425	3,875	21,000	0,827	21,946	0,864	17,825	0,702	0,8	0,8	17,6		387 S/382
		98,425	3,875	21,000	0,827	21,946	0,864	17,825	0,702	2,3	0,8	17,6		387/382
		98,425	3,875	21,000	0,827	21,946	0,864	17,825	0,702	3,5	0,8	17,6		387 A/382

Assembly / Montaje

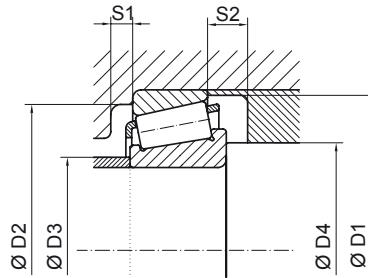

WEIGHT / PESO		ASSEMBLY / MONTAJE							LOAD / CARGA		LOAD FACTORS / FACTORES DE CARGA			SPEED / VELOCIDAD		REFERENCES / REFERENCIAS
		D1 min	D2 min	D2 max	D3 max	D4 min	S1	S2	Dynamic / Dinámica	Static / Estática	Dynamics / Dinámicos	Statics / Estáticos	Oil / Aceite	Grease / Grasa		
kg	lb	mm	mm	mm	mm	mm	mm	mm	C	Co	e	Y	Yo	na	ng	
0,62	1,35	91,5	86,5	93,0	66,0	57,0	4,5	5,0	86,9	108,8	0,35	1,69	0,93	5200	3800	389 A/382 A
0,68	1,50	92,5	86,5	95,0	66,0	59,5	4,5	3,0	86,9	108,8	0,35	1,69	0,93	5100	3800	389 AS/382
0,69	1,52	92,5	86,5	92,5	66,0	57,0	5,5	3,0	86,9	108,8	0,35	1,69	0,93	5100	3700	389 A/383 A
1,40	3,07	99,5	84,5	93,6	64,0	65,5	5,0	7,5	153,3	212,0	0,49	1,23	0,68	4800	3600	HM 807049/HM 807010
1,43	3,15	98,0	89,0	97,0	64,5	65,5	5,5	7,5	156,0	197,7	0,29	2,02	1,11	4800	3600	539/532 X
1,62	3,55	98,0	89,0	100,0	64,5	65,5	5,5	7,5	156,1	197,8	0,30	2,03	1,11	4800	3500	539/532 A
1,87	4,11	114,5	92,0	112,5	67,0	65,5	5,0	11,0	157,3	179,1	0,73	0,81	0,44	4000	3000	72212/72487
3,23	7,10	115,0	101,5	116,0	71,5	65,5	5,5	9,5	268,9	347,7	0,30	2,01	1,11	4300	3200	6280/6220
1,36	2,99	99,5	84,5	93,6	60,0	66,0	5,0	7,5	153,2	212,0	0,49	1,23	0,68	4800	3500	HM 807048/HM 807010
1,64	3,61	100,0	88,5	100,0	65,0	58,0	5,5	4,5	156,1	197,8	0,29	2,02	1,11	4700	3500	538/532
0,53	1,17	86,0	79,0	87,0	62,5	60,5	5,5	4,5	84,5	119,2	0,40	1,49	0,82	5300	3900	JLM 506849/JLM 506810
0,58	1,28	86,0	78,0	87,5	62,5	66,5	5,5	4,5	84,5	119,2		1,49	0,82	5600	3900	JLM 506849 A/JLM 506811
0,81	1,78	90,5	83,0	86,5	63,0	60,5	5,5	5,5	118,1	161,4	0,33	1,79	0,99	5200	3900	JM 207049/JM 207010
0,81	1,78	90,5	83,0	86,5	63,0	74,0	5,5	5,5	118,1	161,4	0,33	1,79	0,99	5200	3900	JM 207049 A/JM 207010
0,60	1,32	91,5	86,5	93,0	66,0	62,5	5,5	5,0	86,9	108,8	0,35	1,69	0,93	5100	3800	385/382 A
0,65	1,42	92,5	86,5	95,0	66,0	62,5	6,0	3,0	86,9	108,8	0,35	1,69	0,93	5100	3800	385/382
1,56	3,42	109,5	85,0	105,0	64,0	65,0	5,5	10,5	137,6	178,1	0,87	0,69	0,38	4100	3000	JW 5549/JW5510
2,56	5,63	116,0	101,0	111,0	77,5	60,0	5,5	7,0	218,8	331,4	0,35	1,67	0,92	4400	3200	5566/5535
2,29	5,04	121,0	105,0	121,0	82,0	67,0	5,5	9,5	178,2	251,3	0,50	1,20	0,66	4200	3100	HM 813840/HM813811
0,57	1,25	91,5	86,5	93,0	66,0	65,0	5,5	5,0	86,9	108,8	0,35	1,69	0,93	5100	3700	387/382 A
0,57	1,25	91,5	86,5	93,0	66,0	68,5	5,5	5,0	86,9	108,8	0,35	1,69	0,93	5100	3700	387 A/382 A
0,57	1,25	91,5	86,5	93,0	66,0	73,0	5,5	5,0	86,9	108,8	0,35	1,69	0,93	5100	3700	387 AS/382 A
0,70	1,54	91,0	83,5	93,0	67,0	68,5	5,5	5,0	97,1	140,8	0,40	1,49	0,82	5000	3700	28682/28621
0,64	1,40	91,5	84,5	88,5	66,0	60,5	6,0	5,0	86,9	108,8	0,35	1,69	0,93	5100	3700	387 S/382 S
0,64	1,40	91,5	84,5	88,5	66,0	65,0	6,0	5,0	86,9	108,8	0,35	1,69	0,93	5100	3700	387/382 S
0,64	1,40	91,5	84,5	88,5	66,0	68,5	6,0	5,0	86,9	108,8	0,35	1,69	0,93	5100	3700	387 A/382 S
0,64	1,40	91,5	84,5	88,5	66,0	73,0	6,0	5,0	86,9	108,8	0,35	1,69	0,93	5100	3700	387 AS/382 S
0,72	1,58	91,0	83,5	94,0	67,0	68,5	6,0	5,0	97,1	140,8	0,40	1,49	0,82	5000	3700	28682/28622
0,61	1,35	92,5	86,5	95,0	66,0	60,5	6,0	3,0	86,9	108,8	0,35	1,69	0,93	5000	3700	387 S/382
0,61	1,35	92,5	86,5	95,0	66,0	65,0	6,0	3,0	86,9	108,8	0,35	1,69	0,93	5000	3700	387/382
0,61	1,35	92,5	86,5	95,0	66,0	68,5	6,0	3,0	86,9	108,8	0,35	1,69	0,93	5000	3700	387 A/382

01.2

INCH SERIES SERIES PULGADAS

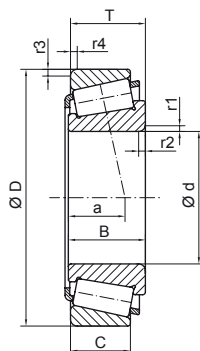
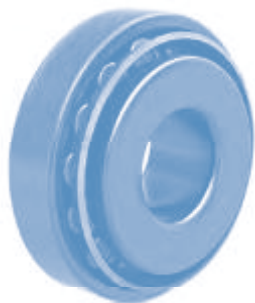

DIMENSIONS / DIMENSIONES												ISO REF / REF ISO	REFERENCES / REFERENCIAS	
d		D		T		B		C		r1/r2 min	r3/r4 min			a
mm	inch	mm	inch	mm	inch	mm	inch	mm	inch	mm	mm	mm		
57,150	2,250	100,000	3,937	21,000	0,827	21,946	0,864	17,825	0,702	0,8	2,0	17,5		387 S/383 A
		100,000	3,937	21,000	0,827	21,946	0,864	17,825	0,702	3,5	2,0	17,6		387 A/383 A
		104,775	4,125	30,162	1,188	29,317	1,154	24,605	0,969	2,3	3,3	24,1		462/453 X
		104,775	4,125	30,162	1,188	29,317	1,154	24,605	0,969	2,3	3,3	24,1		462 A/453 X
		104,775	4,125	30,162	1,188	29,317	1,154	24,605	0,969	3,5	3,3	24,1		469/453 X
		104,775	4,125	30,162	1,187	30,958	1,219	23,812	0,937	0,8	3,3	22,2		45289/45220
		107,950	4,250	27,783	1,094	29,317	1,154	22,225	0,875	3,5	0,8	20,7		469/453 A
		110,000	4,331	22,000	0,866	21,996	0,866	18,824	0,741	2,3	1,3	21,0		390/394 A
		112,712	4,438	30,162	1,188	30,048	1,183	23,812	0,938	3,5	3,3	25,4		3979/3920
		112,712	4,438	30,162	1,188	30,162	1,188	23,812	0,938	3,5	3,3	23,8		39580/39520
		112,712	4,438	30,162	1,188	30,162	1,188	23,812	0,938	8,0	3,3	23,8		39581/39520
		119,985	4,724	32,750	1,289	30,162	1,188	26,949	1,061	3,5	0,8	26,0		39580/39528
		123,825	4,875	38,100	1,500	36,678	1,444	30,162	1,187	3,5	3,3	28,4		555 S/552 A
		140,030	5,513	36,513	1,438	33,236	1,309	23,520	0,926	3,5	2,3	28,5		78225 C/78551
57,531	2,265	98,425	3,875	21,000	0,827	21,946	0,864	17,825	0,702	3,5	0,8	17,6		388 A/382
59,972	2,361	122,238	4,813	33,338	1,313	31,750	1,250	23,813	0,938	0,8	3,3	35,3		66589/66520
59,987	2,362	130,175	5,125	34,100	1,343	30,924	1,218	23,812	0,938	3,5	3,3	41,4		HM 911244/HM 911210
		134,983	5,314	33,449	1,317	30,924	1,218	21,948	0,864	3,5	3,5	40,6		HM 911244/HM 911216
60,000	2,362	95,000	3,740	24,000	0,945	24,000	0,945	19,000	0,748	5,0	2,5	21,4		JLM 508748/JLM 508710
		115,000	4,528	40,000	1,575	39,000	1,535	33,000	1,299	2,5	2,5	27,5	T2EE060	JF 6049/JF 6010
		120,000	4,724	29,795	1,173	29,007	1,142	24,237	0,954	2,0	2,0	25,9		476/472
		125,000	4,921	37,000	1,457	33,500	1,319	26,000	1,024	3,0	3,0	41,8	T7FC060	JW 6049/JW 6010
60,325	2,375	100,000	3,937	25,400	1,000	25,400	1,000	19,845	0,781	3,5	3,3	22,7		28985/28921
		101,600	4,000	25,400	1,000	25,400	1,000	19,845	0,781	3,5	3,3	22,8		28985/28920
		112,712	4,438	30,162	1,188	30,048	1,183	23,812	0,938	3,5	3,3	25,4		3980/3920
		122,238	4,813	38,100	1,500	38,354	1,510	29,718	1,170	8,0	3,3	27,2		HM 212044/HM 212011
		127,000	5,000	36,512	1,438	36,512	1,438	26,988	1,063	3,5	1,5	32,3		HM 813841/HM 813811
		127,000	5,000	36,512	1,438	36,512	1,438	26,988	1,063	3,5	3,3	32,3		HM 813841/HM 813810
		127,000	5,000	44,450	1,750	44,450	1,750	34,925	1,375	3,5	3,3	34,9		65237/65500
		130,175	5,125	36,512	1,438	33,338	1,313	23,812	0,938	5,0	3,3	41,4		HM 911245/HM 911210
		136,525	5,375	46,038	1,813	46,038	1,813	36,512	1,438	3,0	3,3	37,3		H 715332/H 715311
61,912	2,438	110,000	4,331	22,000	0,866	21,996	0,866	18,824	0,741	0,8	1,3	21,1		392/394 A

Assembly / Montaje

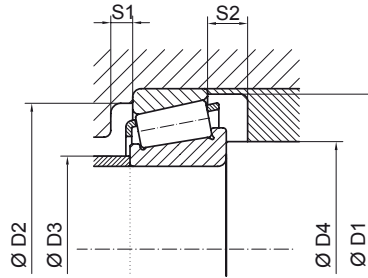

WEIGHT / PESO		ASSEMBLY / MONTAJE							LOAD / CARGA		LOAD FACTORS / FACTORES DE CARGA			SPEED / VELOCIDAD		REFERENCES / REFERENCIAS
		D1 min	D2 min	D2 max	D3 max	D4 min	S1	S2	Dynamic / Dinámica	Static / Estática	Dynamics / Dinámicos	Statics / Estáticos	Oil / Aceite	Grease / Grasa		
kg	lb	mm	mm	mm	mm	mm	mm	mm	C	Co	e	Y	Yo	na	ng	
0,67	1,48	92,5	86,5	92,5	66,0	60,5	5,5	3,0	86,9	109,0	0,35	1,69	0,93	5000	3700	387 S/383 A
0,66	1,45	92,5	86,5	92,5	66,0	68,5	5,0	3,0	86,9	108,8	0,35	1,69	0,93	5000	3700	387 A/383 A
1,03	2,26	98,5	90,0	93,5	68,0	65,0	3,5	5,5	124,3	160,5	0,33	1,79	0,98	4800	3600	462/453 X
1,03	2,26	98,5	90,0	93,5	68,0	65,0	3,5	5,5	124,3	160,5	0,33	1,79	0,98	4800	3600	462 A/453 X
0,97	2,13	98,5	90,0	93,5	68,0	68,5	3,5	5,5	124,3	160,5	0,33	1,79	0,98	4800	3600	469/453 X
1,10	2,41	98,5	91,0	93,5	67,0	60,5	6,0	6,5	139,5	182,4	0,33	1,80	0,99	4800	3600	45289/45220
1,02	2,24	98,5	91,0	104,5	68,0	68,5	5,5	5,5	124,3	160,5	0,33	1,79	0,98	4700	3500	469/453 A
0,93	2,04	105,0	97,5	105,0	76,5	65,0	5,0	3,0	94,7	127,7	0,40	1,49	0,82	4600	3400	390/394 A
1,36	2,99	105,0	95,0	101,5	76,0	68,5	5,5	6,0	127,5	185,8	0,40	1,49	0,82	4500	3400	3979/3920
1,36	2,99	107,5	99,0	101,5	76,5	68,5	5,5	6,0	153,8	217,9	0,34	1,76	0,97	4600	3400	39580/39520
1,36	2,99	107,5	99,0	101,5	76,5	82,0	5,5	6,0	153,8	217,9	0,34	1,76	0,97	4600	3400	39581/39520
1,69	3,72	107,0	98,0	116,0	76,5	68,5	5,5	5,5	153,8	217,9	0,34	1,76	0,97	4400	3300	39580/39528
2,15	4,73	113,0	102,0	112,5	78,5	68,5	6,0	8,0	174,4	240,6	0,35	1,73	0,95	4300	3200	555 S/552 A
2,68	5,90	128,9	104,9	132,0	79,0	68,5	5,5	12,5	186,7	235,5	0,87	0,69	0,38	3500	2600	78225 C/78551
0,62	1,36	92,5	86,5	95,0	66,5	69,0	5,5	3,0	86,9	108,8	0,35	1,69	0,93	5000	3700	388 A/382
1,60	3,52	116,5	98,5	111,0	74,0	63,0	5,5	9,5	146,5	180,0	0,66	0,90	0,49	4000	3000	66589/66520
1,98	4,35	124,0	101,0	119,0	75,0	71,5	5,5	10,0	170,0	205,0	0,82	0,73	0,40	3700	2700	HM 911244/HM 911210
2,10	4,61	123,0	102,0	123,0	75,0	71,5	5,5	11,5	170,0	205,0	0,82	0,73	0,40	3600	2700	HM 911244/HM 911216
0,60	1,32	91,0	83,5	86,5	67,0	76,0	5,5	5,0	89,3	130,8	0,40	1,49	0,82	5000	3700	JLM 508748/JLM 508710
1,84	4,04	109,0	97,0	106,5	70,0	68,5	6,0	7,0	211,9	286,7	0,33	1,80	0,99	4500	3300	JF 6049/JF 6010
1,51	3,32	112,5	103,0	112,5	81,0	67,0	5,5	5,5	131,8	181,2	0,38	1,56	0,85	4300	3200	476/472
2,02	4,44	119,0	93,0	115,0	73,0	70,0	2,5	11,0	161,6	211,8	0,82	0,73	0,40	3800	2800	JW 6049/JW 6010
0,74	1,63	94,5	87,5	90,5	71,0	71,5	5,5	5,5	99,0	147,4	0,43	1,41	0,78	4800	3600	28985/28921
0,79	1,74	96,0	87,5	90,5	71,0	71,5	5,5	5,5	99,0	147,4	0,43	1,41	0,78	4800	3500	28985/28920
1,29	2,84	105,0	95,0	101,5	75,5	71,5	5,5	6,0	127,4	185,9	0,40	1,49	0,82	4500	3300	3980/3920
2,02	4,44	115,0	104,5	111,0	76,5	68,5	5,5	8,0	204,3	268,4	0,34	1,78	0,97	4300	3200	HM 212044/HM 212011
2,19	4,81	121,0	105,0	121,0	82,0	71,5	5,5	9,5	178,1	251,2	0,50	1,20	0,66	4000	3000	HM 813841/HM 813811
2,19	4,81	120,5	105,0	116,0	82,5	71,5	5,5	9,5	178,1	251,2	0,50	1,20	0,66	4000	3000	HM 813841/HM 813810
2,50	5,50	118,5	98,5	116,0	72,0	71,5	5,5	9,5	221,0	287,1	0,48	1,23	0,67	4100	3000	65237/65500
2,02	4,44	124,0	101,0	119,0	75,5	76,0	5,5	12,5	170,0	205,0	0,82	0,73	0,40	3700	2700	HM 911245/HM 911210
3,51	7,72	132,0	112,0	125,5	89,5	71,5	5,5	9,5	239,4	382,9	0,47	1,27	0,70	3900	2900	H 715332/H 715311
0,84	1,85	105,0	97,5	105,0	76,5	65,0	5,0	3,0	94,8	127,7	0,40	1,49	0,82	4500	3300	392/394 A

01.2

INCH SERIES SERIES PULGADAS

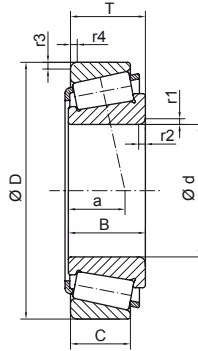

DIMENSIONS / DIMENSIONES												ISO REF / REF ISO	REFERENCES / REFERENCIAS			
d		D		T		B		C		r1/r2 min	r3/r4 min			a		
mm	inch	mm	inch	mm	inch	mm	inch	mm	inch	mm	mm	mm				
61,912	2,438	127,000	5,000	36,512	1,438	36,512	1,438	26,988	1,063	3,5	3,3	32,3		HM 813843/HM 813810		
		136,525	5,375	46,038	1,813	46,038	1,813	36,512	1,438	3,5	3,3	37,3		H 715334/H 715311		
		146,050	5,750	41,275	1,625	39,687	1,563	25,400	1,000	3,5	3,3	45,1		H 913842/H 913810		
		146,050	5,750	41,275	1,625	39,687	1,563	25,400	1,000	7,0	3,3	45,1		H 913843/H 913810		
62,000	2,441	122,238	4,813	43,658	1,719	43,764	1,723	36,513	1,438	1,3	3,3	30,5		5566-62/5535		
63,485	2,499	94,975	3,739	17,000	0,669	15,500	0,610	12,000	0,472	1,0	1,0	28,5		L 910349/L 910310		
63,500	2,500	104,775	4,125	21,433	0,844	22,000	0,866	15,875	0,625	2,0	2,0	19,6		39250/39412		
		107,950	4,250	25,400	1,000	25,400	1,000	19,050	0,750	1,5	0,8	24,6		29586/29522		
		107,950	4,250	25,400	1,000	25,400	1,000	19,050	0,750	1,5	3,3	24,6		29586/29520		
		107,950	4,250	25,400	1,000	25,400	1,000	19,050	0,750	3,5	3,3	24,6		29585/29520		
		110,000	4,331	22,000	0,866	21,996	0,866	18,824	0,741	3,5	1,3	21,1		395/394 A		
		110,000	4,331	30,162	1,188	30,048	1,183	23,812	0,938	3,5	3,3	25,4		3982/3927 X		
		112,712	4,438	30,162	1,188	30,048	1,183	23,812	0,938	3,5	3,3	25,4		3982/3920		
		112,712	4,438	30,162	1,188	30,162	1,188	23,812	0,938	3,5	3,3	23,8		39585/39520		
		122,238	4,813	38,100	1,500	38,354	1,510	29,718	1,170	7,0	3,3	27,2		HM 212047/HM 212011		
		123,825	4,875	38,100	1,500	36,678	1,444	30,162	1,188	3,5	3,3	28,5		559/552 A		
65,000	2,559	105,000	4,134	24,000	0,945	23,000	0,906	18,500	0,728	3,0	1,0	23,3	T4CD065	JLM 710949 C/JLM 710910		
		110,000	4,331	28,000	1,102	28,000	1,102	22,500	0,886	3,0	2,5	24,7	T3DC065	JM 511946/JM 511910		
		110,000	4,331	28,000	1,102	30,000	1,181	22,500	0,886	3,0	2,5	24,7		JM 511945/JM 511910		
		110,000	4,331	31,000	1,221	31,000	1,221	25,000	0,984	2,0	2,0	23,0	T2DD065	JD 6549/JD 6510		
		112,712	4,437	29,020	1,143	30,000	1,181	23,812	0,937	3,0	3,3	25,7		JM 511945/3920		
		120,000	4,724	39,000	1,535	38,500	1,516	32,000	1,260	3,0	2,5	28,5	T2ED065	JH 211749/JH 211710		
		65,088	2,563	135,755	5,345	53,975	2,125	56,007	2,205	44,450	1,750	3,5	3,3	34,5		6379/6320
				136,525	5,375	46,038	1,813	46,038	1,813	36,512	1,438	3,5	3,3	37,3		H 715340/H 715311
		65,987	2,598	123,975	4,881	41,500	1,634	41,500	1,634	34,000	1,339	7,0	3,5	29,2		H 212749/H 212710
		66,675	2,625	107,950	4,250	25,400	1,000	25,400	1,000	19,050	0,750	3,5	0,8	24,6		29590/29522
107,950	4,250			25,400	1,000	25,400	1,000	19,050	0,750	3,5	3,3	24,6		29590/29520		
110,000	4,331			22,000	0,866	21,996	0,866	18,824	0,741	0,8	1,3	21,1		395 A/394 A		
110,000	4,331			22,000	0,866	21,996	0,866	18,824	0,741	3,5	1,3	21,1		395 S/394 A		
110,000	4,331			30,162	1,188	30,048	1,183	23,812	0,938	5,6	3,3	25,4		3994/3927 X		

Assembly / Montaje

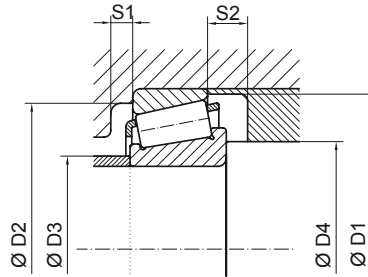

WEIGHT / PESO		ASSEMBLY / MONTAJE							LOAD / CARGA		LOAD FACTORS / FACTORES DE CARGA			SPEED / VELOCIDAD		REFERENCES / REFERENCIAS
		D1 min	D2 min	D2 max	D3 max	D4 min	S1	S2	Dynamic / Dinámica	Static / Estática	Dynamics / Dinámicos	Statics / Estáticos	Oil / Aceite	Grease / Grasa		
kg	lb	mm	mm	mm	mm	mm	mm	mm	C	Co	e	Y	Yo	na	ng	
2,13	4,69	120,5	105,0	116,0	82,0	73,0	5,5	9,5	178,2	251,3	0,50	1,20	0,66	4000	3000	HM 813843/HM 813810
2,50	5,50	132,0	112,0	125,5	89,0	73,0	5,0	9,5	239,4	382,9	0,47	1,27	0,70	3800	2800	H 715334/H 715311
3,09	6,79	138,5	115,0	135,0	83,5	73,0	5,0	15,5	232,4	282,0	0,78	0,76	0,42	3400	2500	H 913842/H 913810
3,09	6,79	138,5	115,0	135,0	83,5	83,0	5,5	15,5	232,4	282,0	0,78	0,76	0,42	3400	2500	H 913843/H 913810
2,34	5,14	116,0	101,0	111,0	77,5	66,5	5,5	7,0	218,8	331,4	0,35	1,67	0,92	4200	3100	5566-62/5535
0,36	0,79	92,0	82,0	90,5	70,0	67,5	5,5	5,0	43,1	64,1	0,78	0,77	0,42	4500	3300	L 910349/L 910310
0,66	1,45	101,0	94,0	94,5	73,5	70,5	5,5	5,5	92,2	121,5	0,39	1,55	0,85	4600	3400	39250/39412
0,90	1,97	102,5	94,0	97,0	77,0	69,0	5,5	6,0	100,3	154,0	0,46	1,31	0,72	4500	3300	29586/29522
0,89	1,96	102,5	94,0	97,0	77,0	69,0	5,5	6,0	100,3	154,0	0,46	1,31	0,72	4500	3300	29586/29520
0,88	1,94	102,5	94,0	97,0	77,0	75,0	5,5	6,0	100,3	154,0	0,46	1,31	0,72	4500	3300	29585/29520
0,81	1,79	105,0	97,5	105,0	76,5	75,0	5,0	3,0	94,8	127,7	0,40	1,49	0,82	4500	3300	395/394 A
1,13	2,49	105,0	95,0	99,0	75,5	75,0	6,0	6,0	127,4	185,9	0,40	1,49	0,82	4500	3300	3982/3927 X
1,22	2,68	105,0	95,0	101,5	75,5	75,0	6,0	6,0	127,4	185,9	0,40	1,49	0,82	4400	3200	3982/3920
1,22	2,68	107,5	99,0	101,5	76,5	75,0	6,0	6,0	153,8	217,9	0,34	1,76	0,97	4400	3300	39585/39520
1,93	4,24	115,0	104,5	111,0	76,5	85,5	6,0	8,0	204,3	268,4	0,34	1,78	0,97	4200	3100	HM 212047/HM 212011
1,97	4,34	113,5	102,5	112,5	78,5	75,0	6,0	7,5	188,6	258,1	0,35	1,73	0,95	4200	3100	559/552 A
2,10	4,61	120,5	105,0	116,0	82,0	75,0	6,0	9,5	178,1	251,4	0,50	1,20	0,66	4000	2900	HM 813842/HM 813810
3,40	7,48	132,0	112,0	125,5	89,5	75,0	6,0	9,5	239,4	382,9	0,47	1,27	0,67	3800	2800	H 715336/H 715311
0,74	1,62	101,0	92,5	101,0	73,0	75,0	6,0	5,5	102,0	139,3	0,45	1,32	0,73	4500	3300	JLM 710949 C/JLM 710910
1,05	2,31	104,5	95,5	101,5	75,0	75,0	6,0	5,5	142,2	201,4	0,40	1,49	0,82	4400	3300	JM 511946/JM 511910
1,07	2,35	104,5	95,5	101,5	75,0	75,0	6,0	5,5	142,2	201,4	0,33	1,79	0,82	4400	3300	JM 511945/JM 511910
1,15	2,53	105,0	97,0	103,0	73,0	72,0	6,0	6,0	148,9	211,5	0,33	1,81	1,00	4500	3300	JD 6549/JD 6510
1,18	2,60	105,0	95,0	101,5	72,5	75,0	4,5	5,0	127,3	184,7	0,40	1,49	0,82	4300	3200	JM 511945/3920
1,80	3,96	114,0	102,0	111,0	75,0	74,0	6,0	7,0	198,3	267,6	0,33	1,77	0,97	4200	3100	JH 211749/JH 211710
3,51	7,72	126,0	109,5	124,5	78,5	76,5	6,0	9,5	280,9	377,0	0,32	1,85	1,01	3900	2900	6379/6320
3,34	7,35	132,0	112,0	125,5	89,5	76,5	6,0	9,5	239,4	382,9	0,47	1,27	0,67	3800	2800	H 715340/H 715311
2,09	4,60	118,5	106,0	112,0	78,0	88,0	6,0	7,5	221,3	300,3	0,33	1,80	0,99	4100	3000	H 212749/H 212710
0,83	1,83	102,5	94,0	97,0	77,0	78,0	6,0	6,0	100,3	154,0	0,46	1,31	0,72	4400	3200	29590/29522
0,83	1,82	102,5	94,0	97,0	77,0	78,0	6,0	6,0	100,3	154,0	0,46	1,31	0,72	4400	3200	29590/29520
0,76	1,67	105,0	97,5	105,0	76,5	70,0	6,0	3,0	94,7	127,7	0,40	1,49	0,82	4400	3200	395 A/394 A
0,76	1,67	105,0	97,5	105,0	76,5	78,0	6,0	3,0	94,7	127,7	0,40	1,49	0,82	4400	3200	395 S/394 A
1,06	2,32	105,0	95,0	99,0	75,5	83,5	6,5	6,0	127,4	185,9	0,40	1,49	0,82	4400	3200	3994/3927 X

01.2

INCH SERIES SERIES PULGADAS

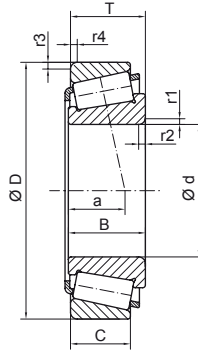

DIMENSIONS / DIMENSIONES												ISO REF / REF ISO	REFERENCES / REFERENCIAS	
d		D		T		B		C		r1/r2 min	r3/r4 min			a
mm	inch	mm	inch	mm	inch	mm	inch	mm	inch	mm	mm	mm		
66,675	2,625	112,712	4,438	30,162	1,188	30,048	1,183	23,812	0,938	3,5	0,8	25,4		3984/3925
		112,712	4,438	30,162	1,188	30,048	1,183	23,812	0,938	3,5	3,3	25,4		3984/3920
		112,712	4,438	30,162	1,188	30,048	1,183	23,812	0,938	5,6	3,3	25,4		3994/3920
		112,712	4,438	30,162	1,188	30,162	1,188	23,812	0,938	3,5	3,3	23,8		39590/39520
		117,475	4,625	30,163	1,188	30,163	1,188	23,813	0,938	0,8	0,8	27,7		33262 A/33461
		117,475	4,625	30,162	1,188	30,163	1,188	23,812	0,938	3,5	3,3	27,6		33262/33462
		122,238	4,813	38,100	1,500	38,354	1,510	29,718	1,170	3,5	1,5	27,2		HM 212049/HM 212010
		122,238	4,813	38,100	1,500	38,354	1,510	29,718	1,170	3,5	3,3	27,2		HM 212049/HM 212011
		130,175	5,125	41,275	1,625	41,275	1,625	31,750	1,250	3,5	3,3	30,0		641/633
		135,755	5,345	53,975	2,125	56,007	2,205	44,450	1,750	4,3	3,3	34,5		6386/6320
		136,525	5,375	41,275	1,625	41,275	1,625	31,750	1,250	3,5	3,3	30,0		641/632
		136,525	5,375	41,275	1,625	41,275	1,625	31,750	1,250	3,5	3,3	30,3		H 414242/H 414210
		136,525	5,375	46,038	1,813	46,038	1,813	36,512	1,438	3,5	3,3	37,3		H 715341/H 715311
68,262	2,688	110,000	4,331	22,000	0,866	21,996	0,866	18,824	0,741	2,3	1,3	21,1		399 A/394 A
		110,000	4,331	22,000	0,866	21,996	0,866	18,824	0,741	5,0	1,3	21,1		399 AS/394 A
		136,525	5,375	46,038	1,813	46,038	1,813	36,512	1,438	3,5	3,3	37,3		H 715343/H 715311
		161,925	6,375	49,212	1,938	46,038	1,813	31,750	1,250	3,5	3,3	47,7		9278/9220
69,850	2,750	101,600	4,000	19,050	0,750	19,050	0,750	15,083	0,594	1,5	1,5	21,6		L 713049/L 713010
		112,712	4,438	25,400	1,000	25,400	1,000	19,050	0,750	1,5	3,3	26,3		29675/29620
		117,475	4,625	30,162	1,188	30,163	1,188	23,812	0,938	3,5	3,3	27,6		33275/33462
		120,000	4,724	29,002	1,142	29,007	1,142	23,444	0,923	3,5	3,3	25,1		482/472 A
		120,000	4,724	29,795	1,173	29,007	1,142	24,237	0,954	3,5	2,0	25,9		482/472
		120,000	4,724	29,794	1,173	30,163	1,188	23,444	0,923	3,5	0,8	27,3		33275/33472
		120,000	4,724	32,545	1,281	32,545	1,281	26,195	1,031	3,5	3,3	25,8		47487/47420
		120,000	4,724	46,751	1,841	45,963	1,810	24,237	0,954	1,0	2,0	25,6		482 E/472
		123,825	4,875	30,162	1,188	29,007	1,142	24,605	0,969	3,5	3,3	26,3		482/472 X
		127,000	5,000	36,512	1,438	36,170	1,424	28,575	1,125	3,5	3,3	28,0		566/563
70,000	2,756	136,525	5,375	41,275	1,625	41,275	1,625	31,750	1,250	3,5	3,3	30,0		643/632
		146,050	5,750	41,275	1,625	39,687	1,563	25,400	1,000	3,5	3,3	45,1		H 913849/H 913810
		110,000	4,331	26,000	1,024	25,000	0,984	20,500	0,807	1,0	2,5	20,5	T4CD070	JLM 813049/JLM 813010
		115,000	4,528	29,000	1,142	29,000	1,142	23,000	0,906	3,0	2,5	26,6	T4DC070	JM 612949/JM 612910
		120,000	4,724	29,002	1,142	29,007	1,142	23,444	0,923	2,0	3,3	25,1	T2ED070	484/472 A

Assembly / Montaje

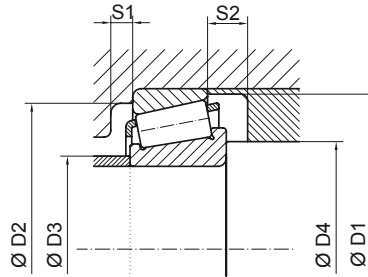

WEIGHT / PESO		ASSEMBLY / MONTAJE							LOAD / CARGA		LOAD FACTORS / FACTORES DE CARGA			SPEED / VELOCIDAD		REFERENCES / REFERENCIAS
		D1 min	D2 min	D2 max	D3 max	D4 min	S1	S2	Dynamic / Dinámica	Static / Estática	Dynamics / Dinámicos	Statics / Estáticos	Oil / Aceite	Grease / Grasa		
kg	lb	mm	mm	mm	mm	mm	mm	mm	C	Co	e	Y	Yo	na	ng	
1,14	2,51	105,0	95,0	109,0	75,5	78,0	6,5	6,0	127,4	185,9	0,40	1,49	0,82	4300	3200	3984/3925
1,14	2,51	105,0	95,0	101,5	75,5	78,0	6,0	6,0	127,4	185,9	0,40	1,49	0,82	4300	3200	3984/3920
1,14	2,51	105,0	95,0	101,5	75,5	83,5	6,0	6,0	127,4	185,9	0,40	1,49	0,82	4300	3200	3994/3920
1,14	2,52	107,5	99,0	101,5	76,5	78,0	6,0	6,0	153,8	217,9	0,34	1,76	0,97	4300	3200	39590/39520
1,33	2,93	111,0	100,5	113,5	82,0	70,0	4,0	6,0	126,5	191,1	0,43	1,37	0,75	4200	3100	33262 A/33461
1,31	2,89	111,5	100,5	106,0	81,0	78,0	6,5	6,0	126,5	191,2	0,43	1,37	0,75	4200	3100	33262/33462
1,85	4,07	115,0	105,0	116,5	76,0	78,0	6,5	8,0	204,3	268,4	0,34	1,78	0,97	4100	3100	HM 212049/HM 212010
1,84	4,05	115,0	104,5	111,0	76,0	78,0	6,5	8,0	204,3	268,4	0,34	1,78	0,97	4100	3100	HM 212049/HM 212011
2,91	6,40	123,5	111,0	119,0	83,5	78,0	7,0	9,5	210,4	286,2	0,36	1,66	0,91	3900	2900	641/633
3,57	7,84	126,0	109,5	124,5	78,5	80,5	7,0	9,5	280,9	377,0	0,32	1,85	1,02	3800	2800	6386/6320
2,73	6,00	123,5	111,0	125,5	84,0	78,0	6,5	9,5	210,3	286,1	0,36	1,66	0,91	3800	2800	641/632
2,73	6,01	128,0	116,5	125,5	84,0	78,0	4,5	9,5	247,4	323,0	0,36	1,67	0,92	3800	2800	H 414242/H 414210
3,28	7,22	132,0	112,0	125,5	89,5	78,0	6,5	9,5	239,4	382,9	0,47	1,27	0,67	3700	2800	H 715341/H 715311
0,73	1,60	105,0	97,5	105,0	76,5	76,0	5,0	3,0	94,8	127,7	0,40	1,49	0,82	4300	3200	399 A/394 A
0,73	1,60	105,0	97,5	105,0	76,5	84,0	5,0	3,0	94,8	127,7	0,40	1,49	0,82	4300	3200	399 AS/394 A
2,27	4,99	132,0	112,0	125,5	89,0	79,5	6,5	9,5	239,4	382,9	0,47	1,27	0,70	3700	2700	H 715343/H 715311
4,61	10,14	153,5	126,0	151,0	90,5	79,5	6,5	17,0	279,8	333,2	0,71	0,85	0,47	3100	2300	9278/9220
0,50	1,10	97,0	90,5	96,0	77,0	75,0	6,5	3,5	63,9	111,7	0,46	1,30	0,72	4500	3300	L 713049/L 713010
0,71	1,55	108,5	99,0	101,5	82,0	75,0	6,5	6,0	104,8	166,6	0,48	1,23	0,67	4200	3100	29675/29620
1,23	2,71	111,5	100,5	106,0	81,0	81,0	6,5	6,0	126,5	191,2	0,43	1,37	0,75	4100	3000	33275/33462
1,25	2,74	112,5	103,0	109,0	80,5	81,0	6,0	5,5	131,8	181,3	0,38	1,56	0,85	4100	3000	482/472 A
1,27	2,79	112,5	103,0	112,5	80,5	81,0	6,5	5,5	131,8	181,3	0,38	1,56	0,85	4100	3000	482/472
1,31	2,88	111,5	100,5	116,5	81,0	81,0	6,5	6,0	126,5	191,2	0,43	1,37	0,75	4000	3000	33275/33472
1,46	3,21	113,5	104,0	109,0	82,0	81,0	6,5	6,0	162,1	238,5	0,36	1,67	0,92	4100	3000	47487/47420
1,65	3,63	112,5	103,0	112,5	80,5	73,5	6,0	22,5	146,1	208,2	0,38	1,56	0,85	4100	3000	482 E/472
1,41	3,11	112,5	102,5	112,5	80,5	81,0	6,5	5,5	131,8	181,3	0,38	1,56	0,85	4000	3000	482/472 X
1,87	4,11	119,0	108,0	116,0	83,5	81,0	6,5	7,5	180,0	254,9	0,36	1,65	0,91	3900	2900	566/563
2,62	5,76	123,5	111,0	125,5	84,0	81,0	6,5	9,5	210,3	286,1	0,36	1,66	0,91	3700	2800	643/632
2,85	6,27	138,5	115,0	135,0	83,5	81,0	6,5	15,5	232,4	282,0	0,78	0,76	0,42	3300	2400	H 913849/H 913810
0,88	1,94	105,5	95,5	101,0	78,0	74,0	6,5	5,5	110,0	172,2	0,49	1,23	0,68	4200	3100	JLM 813049/JLM 813010
1,09	2,39	110,5	100,0	106,0	78,0	80,0	6,5	6,0	135,9	188,8	0,43	1,39	0,76	4200	3100	JM 612949/JM 612910
1,25	2,74	112,5	103,0	109,0	80,5	77,0	6,5	5,5	131,8	181,3	0,38	1,56	0,85	4100	3000	484/472 A

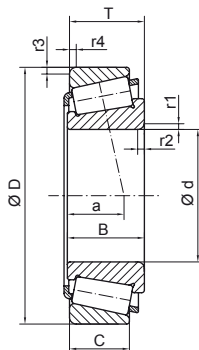
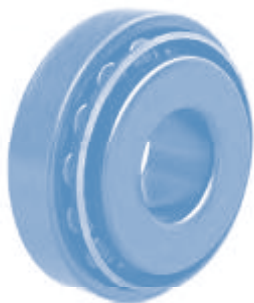

DIMENSIONS / DIMENSIONES												ISO REF / REF ISO	REFERENCES / REFERENCIAS	
d		D		T		B		C		r1/r2 min	r3/r4 min			a
mm	inch	mm	inch	mm	inch	mm	inch	mm	inch	mm	mm	mm		
70,000	2,756	120,000	4,724	29,795	1,173	29,007	1,142	24,237	0,954	2,0	2,0	25,9		484/472
		130,000	5,118	43,000	1,693	42,000	1,654	35,000	1,378	3,0	2,5	12,8	T2ED070	JF 7049/JF 7010
		130,000	5,118	43,000	1,693	42,000	1,654	35,000	1,378	7,0	2,5	12,8	T2ED070A	JF 7049 A/JF 7010
		140,000	5,512	39,000	1,535	35,500	1,398	27,000	1,063	3,0	3,0	47,0	T7FC070	JW 7049/JW 7010
71,438	2,813	117,475	4,625	30,162	1,188	30,163	1,188	23,812	0,938	3,5	3,3	27,6		33281/33462
		120,000	4,724	29,794	1,173	30,163	1,188	23,444	0,923	3,5	0,8	27,3		33281/33472
		120,000	4,724	32,545	1,281	32,545	1,281	26,195	1,031	3,5	3,3	25,8		47490/47420
		127,000	5,000	36,512	1,438	36,512	1,438	26,988	1,063	3,5	1,5	32,3		HM 813849/HM 813811
		127,000	5,000	36,512	1,438	36,512	1,438	26,988	1,063	3,5	3,3	32,3		HM 813849/HM 813810
		136,525	5,375	41,275	1,625	41,275	1,625	31,750	1,250	3,5	3,3	30,0		644/632
		136,525	5,375	41,275	1,625	41,275	1,625	31,750	1,250	6,4	3,3	30,0		645/632
		136,525	5,375	46,038	1,813	46,038	1,813	36,512	1,438	3,5	3,3	37,3		H 715345/H 715311
		73,025	2,875	112,712	4,438	25,400	1,000	25,400	1,000	19,050	0,750	3,5	3,3	26,3
117,475	4,625			30,162	1,188	30,162	1,188	23,812	0,938	3,5	3,3	27,6		33287/33462
120,000	4,724			29,794	1,173	30,162	1,188	23,444	0,923	3,5	0,8	27,3		33287/33472
125,412	4,938			25,400	1,000	25,400	1,000	19,845	0,781	3,5	1,6	25,8		27680/27620
127,000	5,000			36,512	1,438	36,170	1,424	28,575	1,125	3,5	3,3	28,5		567/563
127,000	5,000			36,512	1,438	36,170	1,424	28,575	1,125	4,8	3,3	28,0		567 X/563
139,992	5,512			36,512	1,438	36,098	1,421	28,575	1,125	3,5	3,3	30,8		576/572
73,817	2,906	112,712	4,438	25,400	1,000	25,400	1,000	19,050	0,750	1,5	3,3	26,3		29688/29620
		127,000	5,000	36,512	1,438	36,170	1,424	28,575	1,125	0,8	3,3	28,0		568/563
75,000	2,953	115,000	4,528	25,000	0,984	25,000	0,984	19,000	0,748	3,0	2,5	25,7	T4CC075	JLM 714149/JLM 714110
		120,000	4,724	31,000	1,221	29,500	1,161	25,000	0,984	3,0	2,5	28,6	T4CD075	JM 714249/JM 714210
		145,000	5,709	51,000	2,008	51,000	2,008	42,000	1,654	3,0	2,5	36,8	T2FE075	JH 415647/JH 415610
75,987	2,992	131,975	5,196	39,000	1,535	39,000	1,535	32,000	1,260	7,0	3,5	29,1		HM 215249/HM 215210
76,200	3,000	109,538	4,313	19,050	0,750	19,050	0,750	15,083	0,594	1,5	1,5	23,7		L 814749/L 814710
		121,442	4,781	24,608	0,969	23,012	0,906	17,463	0,688	2,0	2,0	26,1		34300/34478
		127,000	5,000	26,988	1,063	23,012	0,906	19,842	0,781	2,0	3,3	28,5		34300/34500
		127,000	5,000	26,988	1,063	23,012	0,906	19,842	0,781	3,5	3,3	28,5		34301/34500
		127,000	5,000	30,162	1,188	31,000	1,221	22,225	0,875	6,4	3,3	26,8		42688/42620
		133,350	5,250	30,162	1,188	29,769	1,172	22,225	0,875	3,5	3,3	29,5		495 A/492 A
		136,525	5,375	30,162	1,188	29,769	1,172	22,225	0,875	3,5	3,3	29,5		495 A/493

Assembly / Montaje

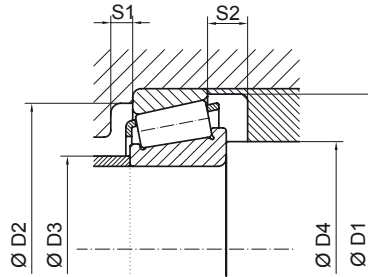

WEIGHT / PESO		ASSEMBLY / MONTAJE							LOAD / CARGA		LOAD FACTORS / FACTORES DE CARGA			SPEED / VELOCIDAD		REFERENCES / REFERENCIAS
									Dynamic / Dinámica	Static / Estática	Dynamics / Dinámicos	Statics / Estáticos	Oil / Aceite	Grease / Grasa		
kg	lb	D1 min	D2 min	D2 max	D3 max	D4 min	S1	S2	C	Co	e	Y	Yo	na	ng	
		mm	mm	mm	mm	mm	mm	mm	kN	kN				rpm	rpm	
1,26	2,78	112,5	103,0	112,5	80,5	77,0	4,0	5,5	131,8	181,3	0,38	1,56	0,85	4100	3000	484/472
2,35	5,16	123,0	110,5	121,0	80,5	80,0	6,5	8,0	254,7	359,0	0,33	1,80	0,99	3900	2900	JF 7049/JF 7010
2,33	5,13	123,0	110,5	121,0	80,5	92,0	6,5	8,0	254,7	359,0	0,33	1,80	0,99	3900	2900	JF 7049 A/JF 7010
2,60	5,71	133,5	105,5	130,0	82,0	80,0	6,5	12,0	200,6	276,1	0,87	0,69	0,38	3300	2400	JW 7049/JW 7010
1,19	2,62	111,5	100,5	106,0	81,0	82,5	6,5	6,0	126,5	191,2	0,43	1,37	0,75	4100	3000	33281/33462
1,27	2,79	111,5	100,5	116,5	81,0	82,5	6,5	6,0	126,5	191,2	0,43	1,37	0,75	4000	3000	33281/33472
1,41	3,10	113,5	104,0	109,0	82,0	82,5	6,5	6,0	162,1	238,5	0,36	1,67	0,92	4100	3000	47490/47420
1,85	4,06	121,0	105,0	121,0	82,0	82,5	6,5	9,5	178,1	251,2	0,50	1,20	0,66	3800	2800	HM 813849/HM 813811
1,85	4,06	120,5	105,0	116,0	82,0	82,5	6,5	9,5	178,2	251,3	0,50	1,20	0,66	3800	2800	HM 813849/HM 813810
3,09	6,80	123,2	111,0	125,5	83,5	82,5	4,5	9,5	210,4	286,2	0,36	1,66	0,91	3700	2800	644/632
2,53	5,57	123,5	111,0	125,5	84,0	91,5	6,5	9,5	210,3	286,1	0,36	1,66	0,91	3700	2800	645/632
2,14	4,71	132,0	112,0	125,5	89,0	82,5	6,5	9,5	239,4	382,9	0,47	1,27	0,70	3600	2700	H 715345/H 715311
0,86	1,89	108,5	99,0	101,5	82,0	84,5	6,5	6,0	104,8	166,6	0,48	1,23	0,67	4100	3000	29685/29620
1,15	2,53	111,5	100,5	106,0	81,0	84,5	6,5	6,0	126,5	191,2	0,43	1,37	0,75	4000	3000	33287/33462
1,23	2,70	111,5	100,5	116,5	81,0	84,5	6,5	6,0	126,5	191,2	0,43	1,37	0,75	4000	2900	33287/33472
1,32	2,89	120,0	112,0	119,5	94,0	84,5	6,5	5,5	115,5	188,7	0,41	1,44	0,79	3900	2900	27680/27620
1,81	3,97	119,0	108,0	116,0	83,5	84,5	6,5	7,5	179,9	254,7	0,36	1,65	0,91	3900	2900	567/563
1,77	3,89	119,0	108,0	116,0	83,5	88,0	6,5	7,5	179,9	254,7	0,36	1,65	0,91	3900	2900	567 X/563
2,33	5,13	131,5	119,0	129,0	95,0	84,5	6,5	7,5	189,5	283,1	0,40	1,48	0,81	3600	2700	576/572
0,84	1,85	108,5	99,0	101,5	82,0	79,0	6,5	6,0	104,8	166,6	0,48	1,23	0,67	4100	3000	29688/29620
1,76	3,87	119,0	108,0	116,0	83,5	77,0	6,5	7,5	179,9	254,8	0,36	1,65	0,91	3900	2900	568/563
0,85	1,88	111,0	102,0	106,0	83,0	84,0	6,5	6,0	108,9	162,0	0,46	1,30	0,72	4000	3000	JLM 714149/JLM 714110
1,30	2,87	115,5	103,5	111,5	83,5	85,0	6,5	6,0	143,7	218,6	0,44	1,35	0,74	3900	2900	JM 714249/JM 714210
3,74	8,22	138,5	121,0	136,5	91,0	84,0	6,5	9,0	332,5	467,6	0,36	1,66	0,91	3600	2700	JH 415647/JH 415610
2,08	4,58	126,0	115,0	120,0	88,0	98,0	6,5	7,0	213,4	306,0	0,33	1,80	0,99	3700	2800	HM 215249/HM 215210
0,56	1,22	105,0	97,5	104,0	85,0	81,5	7,0	3,5	66,4	117,6	0,50	1,19	0,65	4100	3000	L 814749/L 814710
0,95	2,10	115,0	107,5	114,0	88,0	83,0	7,0	7,0	99,4	140,9	0,45	1,33	0,73	3900	2900	34300/34478
1,16	2,54	114,5	105,5	116,0	88,0	83,0	7,0	7,0	99,4	140,9	0,45	1,33	0,73	3800	2800	34300/34500
1,17	2,57	114,5	105,5	116,0	88,0	87,5	7,0	7,0	99,4	140,9	0,45	1,33	0,73	3800	2800	34301/34500
1,40	3,07	120,5	110,5	116,0	88,5	96,0	7,0	7,5	145,5	212,6	0,42	1,43	0,78	3800	2800	42688/42620
1,67	3,66	128,0	118,0	122,0	96,0	87,5	7,0	7,5	143,7	213,5	0,44	1,35	0,74	3600	2700	495 A/492 A
1,78	3,91	128,0	118,0	125,5	96,0	87,5	7,0	7,5	143,7	213,5	0,44	1,35	0,74	3600	2700	495 A/493

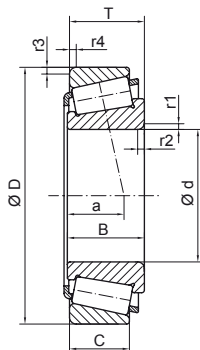

DIMENSIONS / DIMENSIONES												ISO REF / REF ISO	REFERENCES / REFERENCIAS
d		D		T		B		C		r1/r2 min	r3/r4 min		
mm	inch	mm	inch	mm	inch	mm	inch	mm	inch	mm	mm	mm	
76,200	3,000	139,700	5,500	36,512	1,438	36,098	1,421	28,575	1,125	3,5	3,3	31,4	575/572 X
		139,982	5,511	35,250	1,388	36,098	1,421	28,575	1,125	3,5	3,3	30,2	575/572 A
		139,992	5,512	36,512	1,438	36,098	1,421	28,575	1,125	3,5	3,3	31,4	575/572
		146,050	5,750	41,275	1,625	41,275	1,625	31,750	1,250	3,5	3,3	33,2	659/653
		149,225	5,875	53,975	2,125	54,229	2,135	44,450	1,750	3,5	3,3	38,8	6461/6420
		150,089	5,909	44,450	1,750	46,672	1,838	36,512	1,438	3,5	3,3	32,3	748 S/742
		161,925	6,375	49,212	1,938	46,038	1,813	31,750	1,250	3,5	3,3	47,7	9285/9220
77,788	3,063	121,442	4,781	24,608	0,969	23,012	0,906	17,463	0,688	3,5	2,0	26,1	34306/34478
80,000	3,150	130,000	5,118	35,000	1,378	34,000	1,339	28,500	1,122	3,0	2,5	29,9	T3DD080 JM 515649/JM 515610
		160,000	6,299	45,000	1,772	41,000	1,614	31,000	1,221	3,0	3,0	54,7	T7FC080 JW 8049/JW 8010
80,962	3,188	136,525	5,375	30,162	1,188	29,769	1,172	22,225	0,875	3,5	3,3	29,5	496/493
		150,089	5,909	44,450	1,750	46,672	1,838	36,512	1,438	5,0	3,3	32,3	740/742
82,550	3,250	125,412	4,938	25,400	1,000	25,400	1,000	19,845	0,781	3,5	1,6	25,8	27687/27620
		133,350	5,250	30,162	1,188	29,769	1,172	22,225	0,875	3,5	3,3	29,5	495/492 A
		133,350	5,250	33,338	1,313	29,769	1,172	25,400	1,000	3,5	3,3	32,6	495/492
		133,350	5,250	33,338	1,313	33,338	1,313	26,195	1,031	3,5	3,3	29,5	47686/47620
		133,350	5,250	39,688	1,563	39,688	1,563	32,545	1,281	3,5	3,3	32,9	HM 516449 C/HM 516410
		136,525	5,375	30,162	1,188	29,769	1,172	22,225	0,875	3,5	3,3	29,5	495/493
		139,700	5,500	36,512	1,438	36,098	1,421	28,575	1,125	3,5	3,3	31,4	580/572 X
		139,982	5,511	35,250	1,388	36,098	1,421	28,575	1,125	3,5	3,3	30,2	580/572 A
		139,992	5,512	36,512	1,438	36,098	1,421	28,575	1,125	3,5	3,3	31,4	580/572
		146,050	5,750	41,275	1,625	41,275	1,625	31,750	1,250	3,5	3,3	33,5	663/653
		150,089	5,909	44,450	1,750	46,672	1,838	36,512	1,438	3,5	3,3	32,3	749 A/742
		152,400	6,000	41,275	1,625	41,275	1,625	31,750	1,250	3,5	3,3	33,7	663/652
		83,345	3,281	125,412	4,938	25,400	1,000	25,400	1,000	19,845	0,781	3,5	1,6
84,138	3,313	133,350	5,250	30,162	1,188	29,769	1,172	22,225	0,875	3,5	3,3	29,5	498/492 A
		136,525	5,375	30,162	1,188	29,769	1,172	22,225	0,875	3,5	3,3	29,5	498/493
85,000	3,347	130,000	5,118	30,000	1,181	29,000	1,142	24,000	0,945	3,0	2,5	30,0	JM 716649/JM 716610
		140,000	5,512	39,000	1,535	38,000	1,496	31,500	1,240	3,0	2,5	33,2	T3DD085 JHM 516849/JHM 516810
85,026	3,348	150,089	5,909	44,450	1,750	46,672	1,838	36,512	1,438	3,5	3,3	32,3	749/742
		150,089	5,909	44,450	1,750	46,672	1,838	36,512	1,438	5,0	3,3	32,3	749 S/742
85,725	3,375	133,350	5,250	30,162	1,188	29,769	1,172	22,225	0,875	3,5	3,3	29,5	497/492 A

Assembly / Montaje

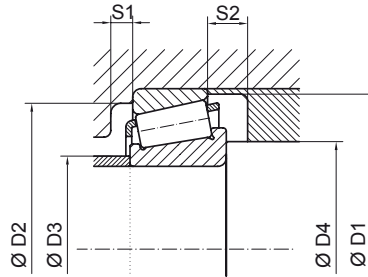

WEIGHT / PESO		ASSEMBLY / MONTAJE							LOAD / CARGA		LOAD FACTORS / FACTORES DE CARGA			SPEED / VELOCIDAD		REFERENCES / REFERENCIAS
									Dynamic / Dinámica	Static / Estática	Dynamics / Dinámicos	Statics / Estáticos	Oil / Aceite	Grease / Grasa		
kg	lb	D1 min	D2 min	D2 max	D3 max	D4 min	S1	S2	C	Co	e	Y	Yo	na	ng	
		mm	mm	mm	mm	mm	mm	mm	kN	kN				rpm	rpm	
2,31	5,08	131,5	119,0	128,5	94,5	87,5	7,0	7,5	189,6	283,2	0,40	1,48	0,81	3600	2600	575/572 X
2,28	5,02	131,5	119,0	129,0	94,5	87,5	7,0	6,5	189,6	283,2	0,40	1,48	0,81	3500	2600	575/572 A
2,32	5,10	131,5	119,0	129,0	94,5	87,5	7,0	7,5	189,6	283,2	0,40	1,48	0,81	3500	2600	575/572
2,92	6,43	139,0	124,5	134,5	97,0	87,5	7,0	9,5	223,2	321,8	0,41	1,46	0,80	3400	2600	659/653
3,75	8,24	139,0	120,0	138,0	90,0	87,5	7,0	9,5	304,0	433,5	0,36	1,66	0,91	3400	2500	6461/6420
3,54	7,78	142,0	129,0	139,0	96,0	87,5	7,0	7,5	287,4	402,3	0,32	1,84	1,01	3400	2500	748 S/742
4,28	9,42	153,5	126,5	151,0	90,5	87,5	7,0	17,0	279,8	333,2	0,71	0,85	0,47	3000	2200	9285/9220
0,89	1,97	115,0	107,5	114,0	88,0	89,0	7,0	7,0	99,4	140,9	0,45	1,33	0,73	3800	2800	34306/34478
1,70	3,74	124,5	112,8	121,0	89,5	90,0	7,0	6,5	179,4	268,1	0,39	1,54	0,85	3700	2700	JM 515649/JM 515610
4,00	8,80	152,5	119,5	150,0	91,0	90,0	7,0	14,0	237,3	322,6	0,87	0,69	0,38	2900	2100	JW 8049/JW 8010
1,64	3,61	128,0	118,0	125,5	96,0	92,5	7,0	7,5	143,7	213,4	0,44	1,35	0,74	3500	2600	496/493
3,32	7,31	142,0	129,0	139,0	96,0	92,5	7,0	7,5	287,4	402,3	0,32	1,84	1,01	3400	2500	740/742
1,05	2,32	120,0	112,0	119,5	93,5	94,0	7,0	5,5	115,5	188,7	0,41	1,44	0,79	3700	2700	27687/27620
1,48	3,26	128,0	118,0	122,0	96,0	94,0	7,0	7,5	143,7	213,5	0,44	1,35	0,74	3500	2600	495/492 A
1,58	3,47	129,5	117,5	130,0	96,0	94,0	7,0	7,5	143,7	213,5	0,44	1,35	0,74	3500	2600	495/492
1,65	3,63	127,0	116,0	122,0	93,5	94,0	7,0	7,0	163,7	251,7	0,40	1,48	0,81	3600	2600	47686/47620
2,14	4,70	127,0	112,5	122,5	92,5	94,0	7,5	7,0	192,9	331,4	0,40	1,49	0,82	3600	2600	HM 516448 C/HM 516410
1,59	3,51	128,0	118,0	125,5	96,0	94,0	7,0	7,5	143,7	213,5	0,44	1,35	0,74	3500	2600	495/493
2,08	4,58	131,5	119,0	128,5	94,5	94,0	7,5	7,5	189,6	283,2	0,40	1,48	0,81	3400	2600	580/572 X
2,06	4,53	131,5	119,0	129,0	94,5	94,0	7,5	6,5	189,6	283,2	0,40	1,48	0,81	3400	2600	580/572 A
2,10	4,61	131,5	119,0	129,0	94,5	94,0	7,0	7,5	189,6	283,2	0,40	1,48	0,81	3400	2600	580/572
2,77	6,09	139,0	124,5	134,5	97,0	94,0	7,5	9,5	223,2	321,8	0,41	1,47	0,81	3300	2500	663/653
3,28	7,21	142,0	129,0	139,0	96,0	94,0	7,0	7,5	287,4	402,3	0,32	1,84	1,01	3300	2500	749 A/742
3,12	6,86	138,5	124,5	141,5	97,0	94,0	7,5	9,5	223,2	321,7	0,41	1,46	0,80	3300	2400	663/652
1,05	2,32	120,0	112,0	119,5	93,5	94,5	7,0	5,5	115,5	188,7	0,41	1,44	0,79	3700	2700	27690/27620
1,44	3,16	128,0	118,0	122,0	96,0	95,5	7,0	7,5	143,7	213,5	0,44	1,35	0,74	3500	2600	498/492 A
1,55	3,40	128,0	118,0	125,5	96,0	95,5	7,0	7,5	143,7	213,5	0,44	1,35	0,74	3400	2600	498/493
1,34	2,94	125,0	113,5	121,5	93,5	95,0	8,0	6,0	146,1	232,3	0,44	1,35	0,74	3500	2600	JM 716649/JM 716610
2,19	4,81	134,5	120,0	131,0	94,5	94,0	8,0	7,5	213,4	323,8	0,40	1,47	0,81	3400	2500	JHM 516849/JHM 516810
3,13	6,89	142,0	129,0	139,0	96,0	96,5	8,0	7,5	287,4	402,3	0,32	1,84	1,01	3300	2400	749/742
3,13	6,89	142,0	129,0	139,0	96,0	101,0	8,5	7,5	287,4	402,3	0,32	1,84	1,01	3300	2400	749 S/742
1,38	3,04	128,0	118,0	122,0	96,0	97,0	8,8	7,5	143,7	213,5	0,44	1,35	0,74	3500	2600	497/492 A

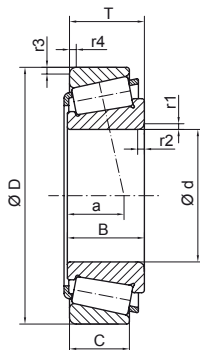

DIMENSIONS / DIMENSIONES												ISO REF / REF ISO	REFERENCES / REFERENCIAS
d		D		T		B		C		r1/r2 min	r3/r4 min		
mm	inch	mm	inch	mm	inch	mm	inch	mm	inch	mm	mm	mm	
85,725	3,375	136,525	5,375	30,162	1,188	29,769	1,172	22,225	0,875	3,5	3,3	29,5	497/493
88,900	3,500	121,442	4,781	15,083	0,594	15,083	0,594	11,112	0,438	1,5	1,5	18,0	LL 217849/LL 217810
		148,430	5,844	28,575	1,125	28,971	1,141	21,433	0,844	3,0	3,0	31,2	42350/42584
		152,400	6,000	39,688	1,563	36,322	1,430	30,162	1,188	3,5	3,3	36,8	593/592 A
		152,400	6,000	39,688	1,563	39,688	1,563	30,162	1,188	6,4	3,3	33,7	HM 518445/HM 518410
		161,925	6,375	47,625	1,875	48,260	1,900	38,100	1,500	3,5	3,3	34,9	759/752
		161,925	6,375	53,975	2,125	55,100	2,169	42,862	1,688	3,5	3,3	41,0	6580/6535
89,974	3,542	146,975	5,786	40,000	1,575	40,000	1,575	32,500	1,280	7,0	3,5	31,2	HM 218248/HM 218210
89,992	3,543	160,096	6,303	30,124	1,186	30,163	1,188	22,301	0,878	2,3	3,3	30,4	69354/69630
90,000	3,543	145,000	5,709	35,000	1,378	34,000	1,339	27,000	1,063	3,0	2,5	33,0	T4DC090 JM 718149/JM 718110
		145,000	5,709	35,000	1,378	34,000	1,339	27,000	1,063	6,0	2,5	33,0	T4DC090A JM 718149 A/JM 718110
		155,000	6,102	44,000	1,732	44,000	1,732	35,500	1,398	3,0	2,5	34,1	JHM 318448/JHM 318410
92,075	3,625	146,050	5,750	33,338	1,313	34,925	1,375	26,195	1,031	3,5	3,3	32,5	47890/47820
		148,430	5,844	28,575	1,125	28,971	1,141	21,433	0,844	3,5	3,0	31,3	42362/42584
		150,000	5,906	35,992	1,417	36,322	1,430	27,000	1,063	3,5	3,0	36,8	598/593 X
		150,000	5,906	35,992	1,417	36,322	1,430	27,000	1,063	6,4	3,0	33,0	598 A/593 X
		152,400	6,000	39,688	1,563	36,322	1,430	30,162	1,188	3,5	3,3	36,8	598/592 A
		152,400	6,000	39,688	1,563	36,322	1,430	30,162	1,188	6,4	3,3	36,8	598 A/592 A
		168,275	6,625	41,275	1,625	41,275	1,625	30,162	1,188	3,5	3,3	38,5	681/672
		168,275	6,625	41,275	1,625	41,275	1,625	30,162	1,188	6,4	3,3	38,5	681 A/672
				148,430	5,844	28,575	1,125	28,971	1,141	21,433	0,844	3,0	3,0
95,000	3,740	135,000	5,315	20,000	0,787	20,000	0,787	14,000	0,551	5,0	2,5	30,8	JL 819349/JL 819310
		150,000	5,906	35,000	1,378	34,000	1,339	27,000	1,063	3,0	2,5	32,7	T4DC095 JM 719149/JM 719113
		160,000	6,299	46,000	1,811	46,000	1,811	38,000	1,496	3,0	3,0	35,5	T2ED095 JF 9549/JF 9510
95,250	3,750	128,587	5,063	15,875	0,625	15,083	0,594	11,908	0,469	1,5	1,5	20,1	LL 319349/LL 319310
		130,175	5,125	20,638	0,813	21,432	0,844	16,670	0,656	1,5	1,5	21,9	L 319249/L 319210
		150,000	5,906	35,992	1,417	36,322	1,430	27,000	1,063	3,5	3,0	36,8	594/593 X
		150,000	5,906	35,992	1,417	36,322	1,430	27,000	1,063	5,0	3,0	33,0	594 A/593 X
		152,400	6,000	39,688	1,563	36,322	1,430	30,162	1,188	3,5	3,3	37,0	594/592 A
		152,400	6,000	39,688	1,563	36,322	1,430	30,162	1,188	5,0	3,3	37,0	594 A/592 A
		168,275	6,625	41,275	1,625	41,275	1,625	30,162	1,188	3,5	3,3	38,5	683/672
96,838	3,813	148,430	5,844	28,575	1,125	28,971	1,141	21,433	0,844	3,5	3,0	31,5	42381/42584

Assembly / Montaje

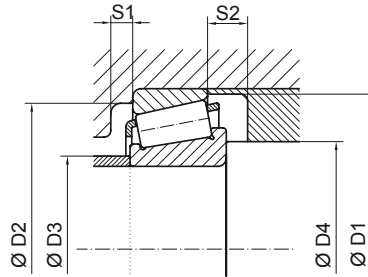

WEIGHT / PESO		ASSEMBLY / MONTAJE							LOAD / CARGA		LOAD FACTORS / FACTORES DE CARGA			SPEED / VELOCIDAD		REFERENCES / REFERENCIAS
									Dynamic / Dinámica	Static / Estática	Dynamics / Dinámicos	Statics / Estáticos	Oil / Aceite	Grease / Grasa		
kg	lb	D1 min	D2 min	D2 max	D3 max	D4 min	S1	S2	C	Co	e	Y	Yo	na	ng	
		mm	mm	mm	mm	mm	mm	mm	kN	kN				rpm	rpm	
1,50	3,30	128,0	118,0	125,5	96,0	97,0	8,8	7,5	143,7	213,5	0,44	1,35	0,74	3400	2500	497/493
0,48	1,06	115,5	113,5	115,5	98,0	94,0	8,0	3,5	56,1	87,6	0,33	1,81	1,00	3800	2800	LL 217849/LL 217810
1,88	4,14	141,0	130,0	138,2	107,0	98,5	8,0	7,0	142,8	220,2	0,49	1,22	0,67	3200	2400	42350/42584
2,71	5,96	142,0	127,2	140,5	105,0	100,0	8,0	9,5	198,7	310,6	0,44	1,36	0,75	3200	2300	593/592 A
2,77	6,10	147,0	133,5	141,0	102,0	109,0	7,0	9,5	270,9	391,4	0,40	1,49	0,82	3200	2400	HM 518445/HM 518410
4,05	8,91	148,5	134,0	151,0	102,0	100,0	8,0	9,5	297,5	427,5	0,34	1,76	0,97	3100	2300	759/752
4,71	10,36	141,5	133,0	151,0	103,0	100,0	8,0	11,0	326,5	491,7	0,40	1,50	0,82	3000	2300	6580/6535
2,52	5,53	141,0	130,0	135,0	100,0	112,0	8,0	7,5	245,9	369,3	0,33	1,80	0,99	3300	2400	HM 218248/HM 218210
2,33	5,12	147,5	137,5	149,0	108,0	97,5	8,0	7,5	172,3	233,1	0,42	1,42	0,78	3000	2300	69354/69630
2,12	4,66	139,0	126,0	136,0	99,5	100,0	8,0	8,0	193,6	288,4	0,44	1,35	0,74	3200	2400	JM 718149/JM 718110
2,08	4,58	139,0	126,0	136,0	99,5	109,0	8,0	8,0	193,6	288,4	0,44	1,35	0,74	3200	2400	JM 718149 A/JM 718110
3,30	7,26	147,5	134,5	146,5	101,0	101,0	2,5	8,5	293,2	420,4	0,34	1,76	0,97	3100	2300	JHM 318448/JHM 318410
2,04	4,49	140,0	127,0	135,0	103,0	103,5	8,0	7,0	180,5	296,8	0,44	1,34	0,73	3200	2400	47890/47820
1,78	3,92	141,0	130,0	138,2	107,0	103,5	8,0	7,0	142,8	220,2	0,49	1,22	0,67	3100	2300	42362/42584
2,60	5,72	142,3	129,4	140,0	105,0	103,5	8,0	8,5	198,7	310,6	0,44	1,36	0,75	3100	2300	598/593 X
2,27	4,99	142,3	129,4	140,0	105,0	112,0	8,0	8,5	198,7	310,6	0,44	1,36	0,75	3100	2300	598 A/593 X
2,55	5,61	142,0	127,2	140,5	105,0	103,5	8,0	9,5	198,7	310,6	0,44	1,36	0,75	3100	2300	598/592 A
2,54	5,58	142,0	127,2	140,5	105,0	112,0	8,5	9,5	198,7	310,6	0,44	1,36	0,75	3100	2300	598 A/592 A
3,83	8,43	157,0	141,0	157,0	114,0	103,5	8,5	11,0	240,9	373,5	0,47	1,28	0,70	2900	2100	681/672
3,80	8,36	157,0	141,0	157,0	114,0	112,5	8,5	11,0	240,9	373,5	0,47	1,28	0,70	2900	2100	681 A/672
1,77	3,89	141,0	130,0	138,2	107,0	103,5	8,5	7,0	142,8	220,2	0,49	1,22	0,67	3100	2300	42368/42584
0,83	1,82	128,5	120,5	124,5	105,0	111,0	9,0	6,0	83,2	142,1	0,58	1,03	0,56	3200	2400	JL 819349/JL 819310
2,17	4,77	142,0	129,0	141,0	105,0	105,0	9,0	8,0	198,8	310,5	0,44	1,36	0,75	3100	2300	JM 719149/JM 719113
3,76	8,27	152,5	138,0	150,0	106,0	105,0	9,0	8,0	317,2	481,7	0,34	1,77	0,97	3100	2300	JF 9549/JF 9510
0,53	1,17	123,5	121,0	123,0	103,5	100,5	9,0	3,5	65,9	109,0	0,35	1,71	0,94	3500	2600	LL 319349/LL 319310
0,79	1,74	123,5	120,5	124,5	105,5	100,5	9,0	3,5	96,3	174,9	0,35	1,72	0,94	3400	2500	L 319249/L 319210
2,20	4,84	142,3	129,4	140,0	105,0	106,5	9,0	8,5	198,7	310,6	0,44	1,36	0,75	3100	2300	594/593 X
2,15	4,73	142,3	129,4	140,0	105,0	111,0	9,0	8,5	198,7	310,6	0,44	1,36	0,75	3100	2300	594 A/593 X
2,49	5,48	142,0	127,2	140,5	105,0	106,5	9,0	9,5	198,7	310,6	0,44	1,36	0,75	3100	2300	594/592 A
2,42	5,33	142,0	127,2	140,5	105,0	111,0	9,0	9,5	198,7	310,6	0,44	1,36	0,75	3100	2300	594 A/592 A
3,68	8,10	157,0	141,0	157,0	114,0	106,5	9,0	11,0	240,9	373,5	0,47	1,28	0,70	2900	2100	683/672
1,66	3,64	141,0	130,0	138,2	107,0	108,0	9,0	7,0	142,8	220,2	0,49	1,22	0,67	3100	2300	42381/42584

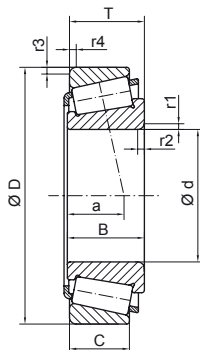

DIMENSIONS / DIMENSIONES													ISO REF / REF ISO	REFERENCES / REFERENCIAS
d		D		T		B		C		r1/r2 min	r3/r4 min	a		
mm	inch	mm	inch	mm	inch	mm	inch	mm	inch	mm	mm	mm		
99,975	3,936	156,975	6,180	42,000	1,654	42,000	1,654	34,000	1,339	8,0	3,5	33,4		HM 220149/HM 220110
100,000	3,937	145,000	5,709	24,000	0,945	22,500	0,886	17,500	0,689	3,0	3,0	29,6	T4CB100	JP 10049/JP 10010
		155,000	6,102	36,000	1,417	35,000	1,378	28,000	1,102	3,0	2,5	36,7	T4DC100	JM 720249/JM 720210
		160,000	6,299	41,000	1,614	40,000	1,575	32,000	1,260	3,0	2,5	38,3	T4DD100	JHM 720249/JHM 720210
		165,000	6,496	47,000	1,850	46,000	1,811	39,000	1,535	3,0	3,0	35,3	T2EE100	JF 10049/JF 10010
101,600	4,000	157,162	6,188	36,512	1,438	36,116	1,422	26,195	1,031	3,5	3,3	36,0		52400/52618
		168,275	6,625	41,275	1,625	41,275	1,625	30,162	1,188	3,5	3,3	38,3		687/672
		214,312	8,438	55,562	2,188	52,388	2,063	39,688	1,563	3,5	3,3	60,3		H 924033/H 924010
107,950	4,250	146,050	5,750	21,433	0,844	21,433	0,844	16,670	0,656	1,5	1,5	26,2		L 521949/L 521910
		158,750	6,250	23,020	0,906	21,438	0,844	15,875	0,625	3,5	3,3	36,8		37425 T/37625 T
		158,750	6,250	23,020	0,906	21,438	0,844	15,875	0,625	3,5	3,3	36,8		37425/37625
		161,925	6,375	34,925	1,375	34,925	1,375	26,988	1,063	3,5	3,3	38,8		48190/48120
		165,100	6,500	36,512	1,438	36,512	1,438	26,988	1,063	3,5	3,3	38,5		56425/56650
109,538	4,313	158,750	6,250	23,020	0,906	21,438	0,844	15,875	0,625	3,5	3,3	36,8		37431/37625
		158,750	6,250	23,020	0,906	21,438	0,844	15,875	0,625	5,0	3,3	36,8		37431 A/37625
110,000	4,331	180,000	7,087	47,000	1,850	46,000	1,811	38,000	1,496	3,0	2,5	40,6		JHM 522649/JHM 522610
114,300	4,500	152,400	6,000	21,432	0,844	21,433	0,844	16,670	0,656	1,5	1,5	27,8		L 623149/L 623110
		177,800	7,000	41,275	1,625	41,275	1,625	30,162	1,188	3,5	3,3	43,0		64450/64700
117,475	4,625	180,975	7,125	34,925	1,375	31,750	1,250	25,400	1,000	3,5	3,3	39,6		68462/68712
120,000	4,724	170,000	6,693	27,000	1,063	25,000	0,984	19,500	0,768	3,0	3,0	35,0	T4CB120	JP 12049/JP 12010
		170,000	6,693	27,000	1,063	25,000	0,984	19,500	0,768	6,0	3,0	35,0	T4CB120A	JP 12049 A/JP 12010
127,000	5,000	165,895	6,531	18,258	0,719	17,462	0,688	13,495	0,531	1,5	1,5	24,3		LL 225749/LL 225710
		182,562	7,187	39,689	1,563	38,100	1,500	33,338	1,313	3,5	3,3	34,0		48290/48220
		215,900	8,500	47,625	1,875	47,625	1,875	34,925	1,375	3,5	3,3	49,9		74500/74850
130,000	5,118	185,000	7,283	29,000	1,142	27,000	1,063	21,000	0,827	3,0	3,0	38,0	T4CB130	JP 13049/JP 13010
133,350	5,250	190,500	7,500	39,687	1,563	39,688	1,563	33,338	1,313	3,5	3,3	35,6		48385/48320
		196,850	7,750	46,038	1,813	46,038	1,813	38,100	1,500	8,0	3,3	38,0		67391/67322
142,875	5,625	200,025	7,875	41,275	1,625	39,688	1,563	34,130	1,344	7,9	3,3	38,3		48684/48620
152,400	6,000	203,200	8,000	41,275	1,625	41,275	1,625	34,925	1,375	3,3	3,3	39,5		LM 330448/LM 330410
190,500	7,500	266,700	10,500	47,625	1,875	46,833	1,844	38,100	1,500	3,5	3,3	57,8		67885/67820

Assembly / Montaje

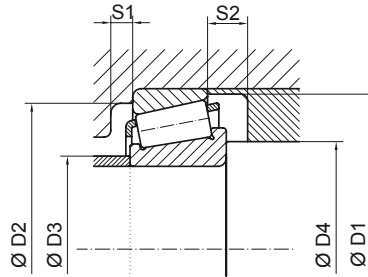

WEIGHT / PESO		ASSEMBLY / MONTAJE								LOAD / CARGA		LOAD FACTORS / FACTORES DE CARGA			SPEED / VELOCIDAD		REFERENCES / REFERENCIAS
		D1 min	D2 min	D2 max	D3 max	D4 min	S1	S2	Dynamic / Dinámica	Static / Estática	Dynamics / Dinámicos	Statics / Estáticos	Oil / Aceite	Grease / Grasa			
kg	lb	mm	mm	mm	mm	mm	mm	mm	mm	kN	kN	e	Y	Yo	na	ng	
2,84	6,25	151,5	139,5	145,0	109,5	125,0	9,5	8,0	285,1	449,1	0,33	1,80	0,99	3000	2200	HM 220149/HM 220110	
0,90	1,98	140,0	132,0	135,0	110,0	110,0	9,0	6,5	126,3	177,0	0,47	1,27	0,70	3100	2300	JP 10049/JP 10010	
2,31	5,08	149,5	134,0	146,0	110,0	110,0	9,0	8,0	202,0	323,7	0,47	1,27	0,70	2900	2100	JM 720249/JM 720210	
3,00	6,60	154,5	137,0	151,5	110,0	110,0	9,0	9,0	250,9	396,9	0,47	1,28	0,70	2900	2100	JHM 720249/JHM 720210	
3,85	8,46	157,5	144,0	154,5	111,0	110,0	9,5	8,0	335,2	518,3	0,32	1,88	1,04	2900	2200	JF 10049/JF 10010	
2,41	5,30	151,5	138,0	146,0	112,5	113,0	9,0	10,0	207,4	337,2	0,47	1,26	0,69	2900	2200	52400/52618	
3,29	7,23	157,0	141,0	157,0	114,0	113,0	9,0	11,0	240,9	373,5	0,47	1,27	0,70	2800	2100	687/672	
9,07	19,95	203,5	171,0	203,0	131,5	113,0	9,0	15,5	434,8	604,0	0,67	0,89	0,49	2200	1700	H 924033/H 924010	
0,99	2,18	139,0	133,5	140,5	117,0	113,5	9,0	4,5	93,3	180,1	0,39	1,53	0,84	3000	2200	L 521949/L 521910	
1,33	2,93	149,5	139,5	147,5	120,0	119,5	9,0	7,0	114,0	187,4	0,60	0,99	0,54	2700	2000	37425 T/37625 T	
1,33	2,93	149,5	139,5	147,5	120,0	119,5	9,0	7,0	114,1	187,5	0,60	0,99	0,54	2700	2000	37425/37625	
2,33	5,13	155,0	140,0	150,5	119,0	119,5	9,0	7,5	175,0	297,2	0,51	1,19	0,65	2700	2000	48190/48120	
2,62	5,76	158,0	143,0	154,0	119,0	119,5	9,0	9,5	210,6	350,7	0,50	1,21	0,66	2700	2000	56425/56650	
1,31	2,88	149,5	139,5	147,5	120,0	121,0	9,0	7,0	114,1	187,5	0,60	0,99	0,54	2700	2000	37431/37625	
1,31	2,87	149,5	139,5	147,5	120,0	125,5	9,0	7,0	114,1	187,5	0,60	0,99	0,54	2700	2000	37431 A/37625	
4,50	9,90	172,0	154,5	171,5	122,5	120,0	9,0	9,0	326,2	515,6	0,41	1,48	0,81	2600	1900	JHM 522649/JHM 522610	
1,03	2,26	146,0	140,0	146,5	125,0	119,5	9,0	4,5	96,9	193,0	0,41	1,45	0,80	2800	2100	L 623149/L 623110	
3,45	7,59	171,0	153,5	166,5	126,5	125,5	9,0	11,0	251,5	407,1	0,52	1,16	0,64	2500	1900	64450/64700	
2,75	6,04	170,0	156,0	170,0	130,0	129,0	9,0	9,5	189,4	279,7	0,50	1,21	0,66	2500	1800	68462/68712	
1,67	3,67	164,5	155,0	159,5	130,0	130,0	9,0	7,5	161,0	246,7	0,47	1,27	0,70	2600	1900	JP 12049/JP 12010	
1,65	3,63	164,5	155,0	159,5	130,0	139,0	9,0	7,5	161,0	246,7	0,47	1,27	0,70	2600	1900	JP 12049 A/JP 12010	
0,93	2,05	158,5	155,5	160,0	138,0	132,5	9,5	4,5	93,6	166,0	0,33	1,80	0,99	2600	1900	LL 225749/LL 225710	
3,26	7,17	174,0	163,0	171,0	141,0	139,0	9,5	6,5	254,5	487,5	0,31	1,97	1,08	2450	1800	48290/48220	
7,01	15,42	205,5	186,0	205,0	141,0	138,5	9,0	12,5	337,6	573,3	0,49	1,23	0,68	2100	1600	74500/74850	
2,17	4,77	179,0	168,5	175,0	141,0	140,0	4,5	8,0	186,0	287,0	0,47	1,27	0,70	2400	1700	JP 13049/JP 13010	
3,56	7,83	182,5	171,5	179,5	142,0	144,5	9,5	6,0	255,7	514,4	0,32	1,87	1,03	2300	1700	48385/48320	
4,50	9,90	189,5	175,0	186,0	146,5	158,0	9,0	7,5	332,1	596,9	0,34	1,74	0,96	2300	1700	67391/67322	
3,84	8,45	190,5	178,0	188,5	155,5	168,0	9,0	7,0	271,1	548,8	0,34	1,78	0,98	2200	1600	48684/48620	
3,48	7,66	197,5	184,0	192,0	162,5	163,0	9,0	6,0	272,4	563,3	0,35	1,73	0,95	2100	1600	LM 330448/LM 330410	
8,04	17,69	257,0	235,5	255,0	209,5	202,5	9,0	9,5	383,5	809,7	0,48	1,26	0,69	1500	1150	67885/67820	

REFERENCES / REFERENCIAS	DIMENSIONS / DIMENSIONES					
	d		D		T	
	mm	inch	mm	inch	mm	inch
336/332	41,275	1,625	80,000	3,150	21,000	0,827
342 A/332	41,275	1,625	80,000	3,150	28,574	1,125
344/332	40,000	1,575	80,000	3,150	21,000	0,827
355/354 X	44,450	1,750	85,000	3,347	20,638	0,813
355 X/352	44,450	1,750	90,119	3,548	23,000	0,906
355 X/354 X	44,450	1,750	85,000	3,347	20,638	0,813
359 A/354 X	46,038	1,813	85,000	3,347	20,638	0,813
359 S/354 X	46,038	1,813	85,000	3,347	20,638	0,813
368/362 A	50,800	2,000	88,900	3,500	20,638	0,813
368 A/362 A	50,800	2,000	88,900	3,500	20,638	0,813
368 A/362 X	50,800	2,000	90,000	3,543	25,000	0,984
368 S/362	51,592	2,031	90,000	3,543	20,000	0,787
368 S/362 A	51,592	2,031	88,900	3,500	20,638	0,813
369 A/362 A	47,625	1,875	88,900	3,500	20,638	0,813
369 A/363	47,625	1,875	90,000	3,543	20,000	0,787
369 S/362	47,625	1,875	90,000	3,543	20,000	0,787
369 S/362 A	47,625	1,875	88,900	3,500	20,638	0,813
369 S/363	47,625	1,875	90,000	3,543	20,000	0,787
385/382	55,000	2,165	98,425	3,875	21,000	0,827
385/382 A	55,000	2,165	96,838	3,813	21,000	0,827
385 A/382	50,800	2,000	98,425	3,875	21,000	0,827
385 A/382 A	50,800	2,000	96,838	3,813	21,000	0,827
386 A/382 A	47,625	1,875	96,838	3,813	21,000	0,827
387/382	57,150	2,250	98,425	3,875	21,000	0,827
387/382 A	57,150	2,250	96,838	3,813	21,000	0,827
387/382 S	57,150	2,250	96,838	3,813	25,400	1,000
387 A/382	57,150	2,250	98,425	3,875	21,000	0,827
387 A/382 A	57,150	2,250	96,838	3,813	21,000	0,827
387 A/382 S	57,150	2,250	96,838	3,813	25,400	1,000
387 A/383 A	57,150	2,250	100,000	3,937	21,000	0,827
387 AS/382 A	57,150	2,250	96,838	3,813	21,000	0,827
387 AS/382 S	57,150	2,250	96,838	3,813	25,400	1,000
387 S/382	57,150	2,250	98,425	3,875	21,000	0,827
387 S/382 S	57,150	2,250	96,838	3,813	25,400	1,000
387 S/383 A	57,150	2,250	100,000	3,937	21,000	0,827
388 A/382	57,531	2,265	98,425	3,875	21,000	0,827
389 A/382 A	53,975	2,125	96,838	3,813	21,000	0,827
389 A/383 A	53,975	2,125	100,000	3,937	21,000	0,827
389 AS/382	53,975	2,125	98,425	3,875	21,000	0,827
390/394 A	57,150	2,250	110,000	4,331	22,000	0,866
392/394 A	61,912	2,438	110,000	4,331	22,000	0,866
395/394 A	63,500	2,500	110,000	4,331	22,000	0,866
395 A/394 A	66,675	2,625	110,000	4,331	22,000	0,866
395 S/394 A	66,675	2,625	110,000	4,331	22,000	0,866
399 A/394 A	68,262	2,688	110,000	4,331	22,000	0,866
399 AS/394 A	68,262	2,688	110,000	4,331	22,000	0,866
418/414	38,100	1,500	88,500	3,484	26,988	1,063

REFERENCES / REFERENCIAS	DIMENSIONS / DIMENSIONES					
	d		D		T	
	mm	inch	mm	inch	mm	inch
419/414	41,275	1,625	88,500	3,484	26,988	1,063
455/453 X	50,800	2,000	104,775	4,125	30,162	1,187
462/453 X	57,150	2,250	104,775	4,125	30,162	1,187
462 A/453 X	57,150	2,250	104,775	4,125	30,162	1,187
469/453 A	57,150	2,250	107,950	4,250	27,783	1,094
469/453 X	57,150	2,250	104,775	4,125	30,162	1,187
476/472	60,000	2,362	120,000	4,724	29,795	1,173
482/472	69,850	2,750	120,000	4,724	29,795	1,173
482/472 A	69,850	2,750	120,000	4,724	29,002	1,142
482/472 X	69,850	2,750	123,825	4,875	30,162	1,187
482 E/472	69,850	2,750	120,000	4,724	46,751	1,841
484/472	70,000	2,756	120,000	4,724	29,795	1,173
484/472 A	70,000	2,756	120,000	4,724	29,002	1,142
495/492	82,550	3,250	133,350	5,250	33,338	1,313
495/492 A	82,550	3,250	133,350	5,250	30,162	1,187
495/493	82,550	3,250	136,525	5,375	30,162	1,187
495 A/492 A	76,200	3,000	133,350	5,250	30,162	1,187
495 A/493	76,200	3,000	136,525	5,375	30,162	1,187
496/493	80,962	3,188	136,525	5,375	30,162	1,187
497/492 A	85,725	3,375	133,350	5,250	30,162	1,187
497/493	85,725	3,375	136,525	5,375	30,162	1,187
498/492 A	84,138	3,313	133,350	5,250	30,162	1,187
498/493	84,138	3,313	136,525	5,375	30,162	1,187
527/522	44,450	1,750	101,600	4,000	34,925	1,375
527 S/522	44,983	1,771	101,600	4,000	34,925	1,375
528/522	47,625	1,875	101,600	4,000	34,925	1,375
529/520 X1	50,800	2,000	100,000	3,937	34,925	1,375
529/522	50,800	2,000	101,600	4,000	34,925	1,375
529 X/522	50,800	2,000	101,600	4,000	34,925	1,375
535/532 X	44,450	1,750	107,950	4,250	36,512	1,437
536/532 X	47,625	1,875	107,950	4,250	36,512	1,437
537/532	50,800	2,000	111,125	4,375	38,100	1,500
537/532 X	50,800	2,000	107,950	4,250	36,512	1,437
538/532	54,988	2,165	111,125	4,375	38,100	1,500
539/532 A	53,975	2,125	111,125	4,375	38,100	1,500
539/532 X	53,975	2,125	107,950	4,250	36,512	1,437
555 S/552 A	57,150	2,250	123,825	4,875	38,100	1,500
559/552 A	63,500	2,500	123,825	4,875	38,100	1,500
566/563	69,850	2,750	127,000	5,000	36,512	1,437
567/563	73,025	2,875	127,000	5,000	36,512	1,437
567 X/563	73,025	2,875	127,000	5,000	36,512	1,437
568/563	73,817	2,906	127,000	5,000	36,512	1,437
575/572	76,200	3,000	139,992	5,512	36,512	1,437
575/572 A	76,200	3,000	139,982	5,511	35,250	1,388
575/572 X	76,200	3,000	139,700	5,500	36,512	1,437
576/572	73,025	2,875	139,992	5,512	36,512	1,437
580/572	82,550	3,250	139,992	5,512	36,512	1,437

REFERENCIAS / REFERENCIAS	DIMENSIONS / DIMENSIONES					
	d		D		T	
	mm	inch	mm	inch	mm	inch
580/572 A	82,550	3,250	139,982	5,511	35,250	1,388
580/572 X	82,550	3,250	139,700	5,500	36,512	1,437
593/592 A	88,900	3,500	152,400	6,000	39,688	1,563
594/592 A	95,250	3,750	152,400	6,000	39,688	1,563
594/593 X	95,250	3,750	150,000	5,906	35,992	1,417
594 A/592 A	95,250	3,750	152,400	6,000	39,688	1,563
594 A/593 X	95,250	3,750	150,000	5,906	35,992	1,417
598/592 A	92,075	3,625	152,400	6,000	39,688	1,563
598/593 X	92,075	3,625	150,000	5,906	35,992	1,417
598 A/592 A	92,075	3,625	152,400	6,000	39,688	1,563
598 A/593 X	92,075	3,625	150,000	5,906	35,992	1,417
619/612	50,800	2,000	120,650	4,750	41,275	1,625
641/632	66,675	2,625	136,525	5,375	41,275	1,625
641/633	66,675	2,625	130,175	5,125	41,275	1,625
643/632	69,850	2,750	136,525	5,375	41,275	1,625
644/632	71,438	2,813	136,525	5,375	41,275	1,625
645/632	71,438	2,813	136,525	5,375	41,275	1,625
659/653	76,200	3,000	146,050	5,750	41,275	1,625
663/652	82,550	3,250	152,400	6,000	41,275	1,625
663/653	82,550	3,250	146,050	5,750	41,275	1,625
681/672	92,075	3,625	168,275	6,625	41,275	1,625
681 A/672	92,075	3,625	168,275	6,625	41,275	1,625
683/672	95,250	3,750	168,275	6,625	41,275	1,625
687/672	101,600	4,000	168,275	6,625	41,275	1,625
740/742	80,962	3,188	150,089	5,909	44,450	1,750
748 S/742	76,200	3,000	150,089	5,909	44,450	1,750
749/742	85,026	3,348	150,089	5,909	44,450	1,750
749 A/742	82,550	3,250	150,089	5,909	44,450	1,750
749 S/742	85,026	3,348	150,089	5,909	44,450	1,750
759/752	88,900	3,500	161,925	6,375	47,625	1,875
1380/1328	22,225	0,875	52,388	2,063	19,368	0,763
1680/1620	33,338	1,313	66,675	2,625	20,638	0,813
1779/1729 X	23,812	0,938	56,896	2,240	19,368	0,763
1780/1729	25,400	1,000	56,896	2,240	19,368	0,763
1985/1922	28,575	1,125	57,150	2,250	19,845	0,781
1985/1930	28,575	1,125	56,896	2,240	19,845	0,781
1985/1931	28,575	1,125	60,325	2,375	19,845	0,781
1985/1932	28,575	1,125	58,738	2,313	19,050	0,750
1986/1931	25,400	1,000	60,325	2,375	19,845	0,781
1986/1932	25,400	1,000	58,738	2,313	19,050	0,750
1988/1922	28,575	1,125	57,150	2,250	19,845	0,781
1988/1931	28,575	1,125	60,325	2,375	19,845	0,781
2580/2520	31,750	1,250	66,421	2,615	25,400	1,000
2580/2523	31,750	1,250	69,850	2,750	23,812	0,937
2585/2523	33,338	1,313	69,850	2,750	23,812	0,937
2689/2631	28,575	1,125	66,421	2,615	23,812	0,937
2780/2720	36,487	1,437	76,200	3,000	23,812	0,937

REFERENCIAS / REFERENCIAS	DIMENSIONS / DIMENSIONES					
	d		D		T	
	mm	inch	mm	inch	mm	inch
2780/2729	36,487	1,437	76,200	3,000	23,812	0,937
2788/2720	38,100	1,500	76,200	3,000	23,812	0,937
2788/2729	38,100	1,500	76,200	3,000	23,812	0,937
2789/2720	39,688	1,563	76,200	3,000	23,812	0,937
2789/2729	39,688	1,563	76,200	3,000	23,812	0,937
2793/2720	34,925	1,375	76,200	3,000	23,813	0,938
2796/2735 X	34,925	1,375	73,025	2,875	23,812	0,937
3381/3320	38,100	1,500	80,167	3,156	29,370	1,156
3382/3320	39,688	1,563	80,167	3,156	29,370	1,156
3384/3320	41,275	1,625	80,167	3,156	29,370	1,156
3386/3320	39,688	1,563	80,167	3,156	29,370	1,156
3386/3325	39,688	1,563	79,975	3,149	29,370	1,156
3477/3420	33,338	1,313	79,375	3,125	29,370	1,156
3478/3420	34,925	1,375	79,375	3,125	29,370	1,156
3490/3420	38,100	1,500	79,375	3,125	29,370	1,156
3577/3520	41,275	1,625	84,138	3,313	30,162	1,187
3577/3525	41,275	1,625	87,312	3,438	30,162	1,187
3578/3520	44,450	1,750	84,138	3,313	30,162	1,187
3578/3525	44,450	1,750	87,312	3,438	30,162	1,187
3585/3525	41,275	1,625	87,312	3,438	30,162	1,187
3586/3525	45,237	1,781	79,975	3,149	30,162	1,187
3767/3720	52,388	2,063	93,264	3,672	30,162	1,187
3776/3720	44,983	1,771	93,264	3,672	30,162	1,187
3778/3720	47,625	1,875	93,264	3,672	30,162	1,187
3779/3720	47,625	1,875	93,264	3,672	30,162	1,187
3780/3720	50,800	2,000	93,264	3,672	30,162	1,187
3780/3727	50,800	2,000	93,662	3,688	30,162	1,187
3782/3720	44,450	1,750	93,264	3,672	30,162	1,187
3784/3720	50,800	2,000	93,264	3,672	30,162	1,187
3784/3727	50,800	2,000	93,662	3,688	30,162	1,187
3877/3820	41,275	1,625	85,725	3,375	30,162	1,187
3878/3820	36,512	1,438	85,725	3,375	30,162	1,187
3879/3820	40,000	1,575	73,025	2,875	30,162	1,187
3979/3920	57,150	2,250	112,712	4,438	30,162	1,187
3980/3920	60,325	2,375	112,712	4,438	30,162	1,187
3982/3920	63,500	2,500	112,712	4,438	30,162	1,187
3982/3927 X	63,500	2,500	110,000	4,331	30,162	1,187
3984/3920	66,675	2,625	112,712	4,438	30,162	1,187
3984/3925	66,675	2,625	112,712	4,438	30,162	1,187
3994/3920	66,675	2,625	112,712	4,438	30,162	1,187
3994/3927 X	66,675	2,625	110,000	4,331	30,162	1,187
JF 4049/JF 4010	40,000	1,575	85,000	3,347	33,000	1,299
4367 X/4335	39,688	1,563	90,488	3,563	39,688	1,563
4388/4335	41,275	1,625	90,488	3,563	39,688	1,563
4395/4335	42,070	1,656	90,488	3,563	39,688	1,563
JF 4549/JF 4510	45,000	1,772	95,000	3,740	36,000	1,417
JW 4549/JW 4510	45,000	1,772	95,000	3,740	29,000	1,142

REFERENCES / REFERENCIAS	DIMENSIONS / DIMENSIONES					
	d		D		T	
	mm	inch	mm	inch	mm	inch
4580/4535	50,800	2,000	104,775	4,125	39,687	1,562
JF 5049/JF 5010	50,000	1,969	100,000	3,937	36,000	1,417
JW 5049/JW 5010	50,000	1,969	105,000	4,134	32,000	1,260
5395/5335	49,212	1,938	103,188	4,063	43,658	1,719
JW 5549/JW5510	55,000	2,165	115,000	4,528	34,000	1,339
5566/5535	55,562	2,188	122,238	4,813	43,658	1,719
5566-62/5535	62,000	2,441	122,238	4,813	43,658	1,719
JF 6049/JF 6010	60,000	2,362	115,000	4,528	40,000	1,575
JW 6049/JW 6010	60,000	2,362	125,000	4,921	37,000	1,457
A 6075/A 6157	19,050	0,750	39,992	1,575	12,014	0,473
6280/6220	53,975	2,125	127,000	5,000	50,800	2,000
6379/6320	65,088	2,563	135,755	5,345	53,975	2,125
6386/6320	66,675	2,625	135,755	5,345	53,975	2,125
6461/6420	76,200	3,000	149,225	5,875	53,975	2,125
JD 6549/JD 6510	65,000	2,559	110,000	4,331	31,000	1,220
6580/6535	88,900	3,500	161,925	6,375	53,975	2,125
JF 7049/JF 7010	70,000	2,756	130,000	5,118	43,000	1,693
JF 7049 A/JF 7010	70,000	2,756	130,000	5,118	43,000	1,693
JW 7049/JW 7010	70,000	2,756	140,000	5,512	39,000	1,535
JW 8049/JW 8010	80,000	3,150	160,000	6,299	45,000	1,772
9278/9220	68,262	2,688	161,925	6,375	49,212	1,937
9285/9220	76,200	3,000	161,925	6,375	49,212	1,937
JF 9549/JF 9510	95,000	3,740	160,000	6,299	46,000	1,811
02474/02420	28,575	1,125	68,262	2,688	22,225	0,875
02475/02420	31,750	1,250	68,262	2,688	22,225	0,875
02872/02820	28,575	1,125	73,025	2,875	22,225	0,875
05066/05185	16,993	0,669	47,000	1,850	14,382	0,566
07087/07204	22,225	0,875	51,994	2,047	15,011	0,591
07087/07210 X	22,225	0,875	50,800	2,000	15,011	0,591
07087 X/07204	22,225	0,875	51,994	2,047	15,011	0,591
07087 X/07210 X	22,225	0,875	50,800	2,000	15,011	0,591
07097/07204	25,000	0,984	51,994	2,047	15,011	0,591
07100/07196	25,400	1,000	50,005	1,969	13,495	0,531
07100/07204	25,400	1,000	51,994	2,047	15,011	0,591
07100 S/07196	25,400	1,000	50,005	1,969	13,495	0,531
07100 S/07210 X	25,400	1,000	50,800	2,000	15,011	0,591
09067/09195	19,050	0,750	49,225	1,938	18,034	0,710
09067/09196	19,050	0,750	49,225	1,938	21,209	0,835
09074/09194	19,050	0,750	49,225	1,938	23,020	0,906
09074/09195	19,050	0,750	49,225	1,938	19,845	0,781
09074/09196	19,050	0,750	49,225	1,938	23,020	0,906
09081/09195	20,625	0,812	49,225	1,938	19,845	0,781
09081/09196	20,625	0,812	49,225	1,938	23,020	0,906
JF 10049/JF 10010	100,000	3,937	165,000	6,496	47,000	1,850
JP 10049/JP 10010	100,000	3,937	145,000	5,709	24,000	0,945
11162/11300	41,275	1,625	76,200	3,000	18,009	0,709
11163/11300	41,275	1,625	76,200	3,000	18,009	0,709

REFERENCES / REFERENCIAS	DIMENSIONS / DIMENSIONES					
	d		D		T	
	mm	inch	mm	inch	mm	inch
11590/11520	15,875	0,625	42,862	1,688	14,288	0,563
LM 11749/LM 11710	17,462	0,688	39,878	1,570	13,843	0,545
LM 11949/LM 11910	19,050	0,750	45,237	1,781	15,494	0,610
LM 11949 RS/LM 11910	19,050	0,750	45,237	1,781	15,494	0,610
JP 12049/JP 12010	120,000	4,724	170,000	6,693	27,000	1,063
JP 12049 A/JP 12010	120,000	4,724	170,000	6,693	27,000	1,063
M 12649/M 12610	21,430	0,844	50,005	1,969	17,526	0,690
M 12649 F/M 12610 F	21,430	0,844	50,005	1,969	17,026	0,670
LM 12748/LM 12710	21,430	0,844	45,237	1,781	15,494	0,610
LM 12749/LM 12710	21,986	0,866	45,237	1,781	15,494	0,610
LM 12749/LM 12711	21,986	0,866	45,974	1,810	15,494	0,610
JP 13049/JP 13010	130,000	5,118	185,000	7,283	29,000	1,142
13685/13621	38,100	1,500	69,012	2,717	19,050	0,750
13686/13620	38,100	1,500	69,012	2,717	26,195	1,031
13687/13620	38,100	1,500	69,012	2,717	19,050	0,750
13687/13621	38,100	1,500	69,012	2,717	19,050	0,750
13889/13836	38,100	1,500	65,088	2,563	12,700	0,500
14116/14276	30,226	1,190	69,012	2,717	19,845	0,781
14118/14274	30,000	1,181	69,012	2,717	19,845	0,781
14118/14283	30,000	1,181	72,085	2,838	22,385	0,881
14123 AA/14274	31,750	1,250	69,012	2,717	26,983	1,062
14123 AA/14276	31,750	1,250	69,012	2,717	26,983	1,062
14125 A/14274	31,750	1,250	69,012	2,717	19,845	0,781
14125 A/14276	31,750	1,250	69,012	2,717	19,845	0,781
14125 A/14283	31,750	1,250	72,085	2,838	22,385	0,881
14130/14274	33,338	1,313	69,012	2,717	19,845	0,781
14130/14276	33,338	1,313	69,012	2,717	19,845	0,781
14131/14274	33,338	1,313	69,012	2,717	19,845	0,781
14131/14276	33,338	1,313	69,012	2,717	19,845	0,781
14136 A/14276	34,925	1,375	69,012	2,717	26,983	1,062
14137 A/14274	34,925	1,375	69,012	2,717	19,845	0,781
14137 A/14276	34,925	1,375	69,012	2,717	19,845	0,781
14137 AS/14276	34,925	1,375	69,012	2,717	19,845	0,781
14138 A/14274	34,925	1,375	69,012	2,717	19,845	0,781
14138 A/14276	34,925	1,375	69,012	2,717	19,845	0,781
14138 A/14283	34,925	1,375	72,085	2,838	22,385	0,881
14585/14525	34,925	1,375	68,262	2,688	20,638	0,813
15100/15245	25,400	1,000	62,000	2,441	19,050	0,750
15100/15250	25,400	1,000	63,500	2,500	20,638	0,813
15100/15250 X	25,400	1,000	63,500	2,500	20,638	0,813
15101/15245	25,400	1,000	62,000	2,441	19,050	0,750
15101/15250	25,400	1,000	63,500	2,500	20,638	0,813
15101/15250 X	25,400	1,000	63,500	2,500	20,638	0,813
15103 S/15243	26,162	1,030	61,912	2,438	19,050	0,750
15103 S/15245	26,162	1,030	62,000	2,441	19,050	0,750
15106/15245	26,988	1,063	62,000	2,441	19,050	0,750
15106/15250	26,988	1,063	63,500	2,500	20,638	0,813

REFERENCIAS / REFERENCIAS	DIMENSIONS / DIMENSIONES					
	d		D		T	
	mm	inch	mm	inch	mm	inch
15106/15250 X	26,988	1,063	63,500	2,500	20,638	0,813
15112/15245	28,575	1,125	62,000	2,441	19,050	0,750
15112/15250	28,575	1,125	63,500	2,500	20,638	0,813
15112/15250 X	28,575	1,125	63,500	2,500	20,638	0,813
15117/15245	29,987	1,181	62,000	2,441	19,050	0,750
15118/15245	30,213	1,190	62,000	2,441	19,050	0,750
15118/15250	30,213	1,190	63,500	2,500	20,638	0,813
15118/15250 X	30,213	1,190	63,500	2,500	20,638	0,813
15120/15250 X	30,213	1,190	63,500	2,500	20,638	0,813
15123/15244	31,750	1,250	62,000	2,441	19,749	0,778
15123/15245	31,750	1,250	62,000	2,441	18,161	0,715
15123/15250 X	31,750	1,250	63,500	2,500	19,749	0,778
15125/15245	31,750	1,250	62,000	2,441	19,050	0,750
15126/15245	31,750	1,250	62,000	2,441	19,050	0,750
15126/15250	31,750	1,250	63,500	2,500	20,638	0,813
15126/15250 X	31,750	1,250	63,500	2,500	20,638	0,813
15578/15520	25,400	1,000	57,150	2,250	17,462	0,687
15579 X/15520	25,987	1,023	57,150	2,250	17,462	0,687
15580/15520	26,988	1,063	57,150	2,250	17,462	0,687
J 15585/15520	28,000	1,102	57,150	2,250	17,462	0,687
16150/16284	38,100	1,500	72,238	2,844	20,638	0,813
17887/17831	45,230	1,781	79,985	3,149	19,842	0,781
18590/18520	41,275	1,625	73,025	2,875	16,667	0,656
18690/18620	46,038	1,813	79,375	3,125	17,462	0,687
18790/18720	50,800	2,000	85,000	3,347	17,462	0,687
19150/19268	38,100	1,500	68,262	2,688	15,875	0,625
21075/21212	19,050	0,750	53,975	2,125	22,225	0,875
23690/23620	34,925	1,375	73,025	2,875	26,988	1,063
24780/24720	41,275	1,625	76,200	3,000	22,225	0,875
24780/24721	41,275	1,625	76,200	3,000	25,400	1,000
24781/24720	41,275	1,625	76,200	3,000	22,225	0,875
24781/24721	41,275	1,625	76,200	3,000	25,400	1,000
25576/25520	42,862	1,688	82,931	3,265	23,812	0,937
25577/25520	42,875	1,688	82,931	3,265	23,812	0,937
25577/25521	42,875	1,688	83,058	3,270	23,812	0,937
25577/25522	42,875	1,688	83,058	3,270	23,876	0,940
25577/25523	42,875	1,688	82,931	3,265	26,988	1,063
25578/25520	42,862	1,688	82,931	3,265	23,812	0,937
25578/25521	42,862	1,688	83,058	3,270	23,812	0,937
25578/25522	42,862	1,688	83,058	3,270	23,876	0,940
25578/25523	42,862	1,688	82,931	3,265	26,988	1,063
25580/25520	44,450	1,750	82,931	3,265	23,812	0,937
25580/25521	44,450	1,750	83,058	3,270	23,812	0,937
25580/25522	44,450	1,750	83,058	3,270	23,876	0,940
25580/25523	44,450	1,750	82,931	3,265	26,988	1,063
25581/25520	44,450	1,750	82,931	3,265	23,813	0,938
25584/25520	44,983	1,771	82,931	3,265	23,812	0,937

REFERENCIAS / REFERENCIAS	DIMENSIONS / DIMENSIONES					
	d		D		T	
	mm	inch	mm	inch	mm	inch
25584/25521	44,983	1,771	83,058	3,270	23,813	0,938
25584/25547 RB	44,983	1,771	99,995	3,937	25,400	1,000
25584 A/25520	44,987	1,771	82,931	3,265	23,812	0,937
25590/25520	45,618	1,796	82,931	3,265	23,812	0,937
25590/25521	45,618	1,796	83,058	3,270	23,812	0,937
25590/25522	45,618	1,796	83,058	3,270	23,876	0,940
25590/25523	45,618	1,796	82,931	3,265	26,988	1,063
25877/25820	34,925	1,375	73,025	2,875	23,812	0,937
25877/25821	34,925	1,375	73,025	2,875	23,812	0,937
25878/25820	34,925	1,375	73,025	2,875	23,812	0,937
25880/25820	36,487	1,437	73,025	2,875	23,812	0,937
25880/25821	36,487	1,437	73,025	2,875	23,812	0,937
JL 26749 F/JL 26710	32,000	1,260	53,000	2,087	14,500	0,571
26878/26823	38,100	1,500	76,200	3,000	25,400	1,000
26882/26820	41,275	1,625	80,167	3,156	25,400	1,000
26882/26822	41,275	1,625	79,375	3,125	23,812	0,937
26882 T/26822	41,275	1,625	79,375	3,125	23,812	0,937
26884/26823	42,875	1,688	76,200	3,000	25,400	1,000
27680/27620	73,025	2,875	125,412	4,938	25,400	1,000
27687/27620	82,550	3,250	125,412	4,938	25,400	1,000
27690/27620	83,345	3,281	125,412	4,938	25,400	1,000
28137/28317	34,925	1,375	80,035	3,151	21,433	0,844
28579/28520	49,987	1,968	89,980	3,543	24,750	0,974
28580/28520	50,800	2,000	89,980	3,543	24,750	0,974
28580/28521	50,800	2,000	92,075	3,625	24,608	0,969
28580/28527 RB	50,800	2,000	99,995	3,937	24,607	0,969
28584/28521	52,388	2,063	92,075	3,625	24,608	0,969
28682/28621	57,150	2,250	96,838	3,813	24,608	0,969
28682/28622	57,150	2,250	97,630	3,844	24,608	0,969
28985/28920	60,325	2,375	101,600	4,000	25,400	1,000
28985/28921	60,325	2,375	100,000	3,937	25,400	1,000
29585/29520	63,500	2,500	107,950	4,250	25,400	1,000
29586/29520	63,500	2,500	107,950	4,250	25,400	1,000
29586/29522	63,500	2,500	107,950	4,250	25,400	1,000
29590/29520	66,675	2,625	107,950	4,250	25,400	1,000
29590/29522	66,675	2,625	107,950	4,250	25,400	1,000
29675/29620	69,850	2,750	112,712	4,438	25,400	1,000
29685/29620	73,025	2,875	112,712	4,438	25,400	1,000
29688/29620	73,817	2,906	112,712	4,438	25,400	1,000
LM 29748/LM 29710	38,100	1,500	65,088	2,563	18,034	0,710
LM 29748/LM 29711	38,100	1,500	65,088	2,563	18,034	0,710
LM 29749/LM 29710	38,100	1,500	65,088	2,563	18,034	0,710
LM 29749/LM 29711	38,100	1,500	65,088	2,563	19,812	0,780
31593/31520	34,925	1,375	76,200	3,000	29,370	1,156
31594/31520	34,925	1,375	76,200	3,000	29,370	1,156
33262/33462	66,675	2,625	117,475	4,625	30,162	1,187
33262 A/33461	66,675	2,625	117,475	4,625	30,163	1,188

REFERENCIAS / REFERENCIAS	DIMENSIONS / DIMENSIONES					
	d		D		T	
	mm	inch	mm	inch	mm	inch
33275/33462	69,850	2,750	117,475	4,625	30,162	1,187
33275/33472	69,850	2,750	120,000	4,724	29,794	1,173
33281/33462	71,438	2,813	117,475	4,625	30,162	1,187
33281/33472	71,438	2,813	120,000	4,724	29,794	1,173
33287/33462	73,025	2,875	117,475	4,625	30,162	1,187
33287/33472	73,025	2,875	120,000	4,724	29,794	1,173
33885/33822	44,450	1,750	95,250	3,750	27,783	1,094
33889/33821	50,800	2,000	95,250	3,750	27,783	1,094
33889/33822	50,800	2,000	95,250	3,750	27,783	1,094
33891/33821	52,388	2,063	95,250	3,750	27,783	1,094
33895/33821	53,975	2,125	95,250	3,750	27,783	1,094
33895/33822	53,975	2,125	95,250	3,750	27,783	1,094
34300/34478	76,200	3,000	121,442	4,781	24,608	0,969
34300/34500	76,200	3,000	127,000	5,000	26,988	1,063
34301/34500	76,200	3,000	127,000	5,000	26,988	1,063
34306/34478	77,788	3,063	121,442	4,781	24,608	0,969
37425/37625	107,950	4,250	158,750	6,250	23,020	0,906
37425 T/37625 T	107,950	4,250	158,750	6,250	23,020	0,906
37431/37625	109,538	4,313	158,750	6,250	23,020	0,906
37431 A/37625	109,538	4,313	158,750	6,250	23,020	0,906
39250/39412	63,500	2,500	104,775	4,125	21,433	0,844
39580/39520	57,150	2,250	112,712	4,438	30,162	1,187
39580/39528	57,150	2,250	119,985	4,724	32,750	1,289
39581/39520	57,150	2,250	112,712	4,438	30,162	1,187
39585/39520	63,500	2,500	112,712	4,438	30,162	1,187
39590/39520	66,675	2,625	112,712	4,438	30,162	1,187
41125/41286	28,575	1,125	72,626	2,859	24,608	0,969
42350/42584	88,900	3,500	148,430	5,844	28,575	1,125
42362/42584	92,075	3,625	148,430	5,844	28,575	1,125
42368/42584	93,662	3,688	148,430	5,844	28,575	1,125
42381/42584	96,838	3,813	148,430	5,844	28,575	1,125
42688/42620	76,200	3,000	127,000	5,000	30,162	1,187
44162/44348	41,275	1,625	88,500	3,484	25,400	1,000
L 44643/L 44610	25,400	1,000	50,292	1,980	14,224	0,560
L 44643 R/L 44610	25,400	1,000	50,292	1,980	14,224	0,560
L 44645/L 44613	25,987	1,023	51,986	2,047	15,011	0,591
L 44649/L 44610	26,988	1,063	50,292	1,980	14,224	0,560
45284/45220	50,800	2,000	104,775	4,125	30,162	1,187
45285 A/45220	50,800	2,000	104,775	4,125	30,162	1,187
45285 A/45221	50,800	2,000	104,775	4,125	30,162	1,187
45289/45220	57,150	2,250	104,775	4,125	30,162	1,187
L 45449/L 45410	29,000	1,142	50,292	1,980	14,224	0,560
47487/47420	69,850	2,750	120,000	4,724	32,545	1,281
47490/47420	71,438	2,813	120,000	4,724	32,545	1,281
47686/47620	82,550	3,250	133,350	5,250	33,338	1,313
47890/47820	92,075	3,625	146,050	5,750	33,338	1,313
48190/48120	107,950	4,250	161,925	6,375	34,925	1,375

REFERENCIAS / REFERENCIAS	DIMENSIONS / DIMENSIONES					
	d		D		T	
	mm	inch	mm	inch	mm	inch
48385/48320	133,350	5,250	190,500	7,500	39,687	1,562
LM 48548/LM 48510	34,925	1,375	65,088	2,563	18,034	0,710
LM 48548/LM 48514 XP	34,925	1,375	68,262	2,688	18,034	0,710
LM 48548 RSLM 48510	34,925	1,375	65,088	2,563	18,034	0,710
49162/49368	41,275	1,625	93,662	3,688	31,750	1,250
49175/49368	44,450	1,750	93,662	3,688	31,750	1,250
49585/49520	50,800	2,000	101,600	4,000	31,750	1,250
52400/52618	101,600	4,000	157,162	6,188	36,512	1,437
53176/53375	44,450	1,750	95,250	3,750	30,958	1,219
53177/53375	44,450	1,750	95,250	3,750	30,958	1,219
53178/53377	44,450	1,750	95,250	3,750	30,958	1,219
55175 C/55437	44,450	1,750	111,125	4,375	30,162	1,187
55187 C/55437	47,625	1,875	111,125	4,375	30,162	1,187
55200 C/55437	50,800	2,000	111,125	4,375	30,162	1,187
55206 C/55437	52,388	2,063	111,125	4,375	30,162	1,187
56425/56650	107,950	4,250	165,100	6,500	36,512	1,437
59162/59412	41,275	1,625	104,775	4,125	36,512	1,437
64450/64700	114,300	4,500	177,800	7,000	41,275	1,625
65237/65500	60,325	2,375	127,000	5,000	44,450	1,750
66589/66520	59,972	2,361	122,238	4,813	33,338	1,313
LM 67048/LM 67010	31,750	1,250	59,131	2,328	15,875	0,625
LM 67048/LM 67010 BA	31,750	1,250	58,877	2,318	15,875	0,625
LM 67048/LM 67014	31,750	1,250	61,986	2,440	15,875	0,625
LM 67048/LM 67014 X	31,750	1,250	61,986	2,440	15,875	0,625
LM 67048 RSLM 67010	31,750	1,250	59,131	2,328	15,875	0,625
LM 67049/LM 67011	31,750	1,250	59,131	2,328	17,780	0,700
LM 67049 A/LM 67010	31,750	1,250	59,131	2,328	15,875	0,625
LM 67049 A/LM 67014	31,750	1,250	61,986	2,440	15,875	0,625
LM 67049 AXLM 67010 X	31,750	1,250	59,131	2,328	15,875	0,625
67391/67322	133,350	5,250	196,850	7,750	46,038	1,813
JL 68145/JL 68111 Z	35,000	1,378	60,000	2,362	15,875	0,625
L 68149/L 68110	34,987	1,377	59,131	2,328	15,875	0,625
L 68149/L 68111	34,987	1,377	59,975	2,361	15,875	0,625
L 68149/L 68116	34,987	1,377	65,088	2,563	15,875	0,625
L 68149 R/L 68110	34,987	1,377	59,131	2,328	15,875	0,625
68462/68712	117,475	4,625	180,975	7,125	34,925	1,375
JL 69345/JL 69310	38,000	1,496	63,000	2,480	17,000	0,669
JL 69345/L 69310 Z	38,000	1,496	63,000	2,480	17,000	0,669
JL 69349/JL 69310	38,000	1,496	63,000	2,480	17,000	0,669
69354/69630	89,992	3,543	160,096	6,303	30,124	1,186
72187/72487	47,625	1,875	123,825	4,875	36,512	1,437
72200 C/72487	50,800	2,000	123,825	4,875	36,512	1,437
72212/72487	53,975	2,125	123,825	4,875	36,512	1,437
74500/74850	127,000	5,000	215,900	8,500	47,625	1,875
78225 C/78551	57,150	2,250	140,030	5,513	36,513	1,438
LM 78349/LM 78310 A	34,987	1,377	61,975	2,440	16,700	0,657
HM 81649/HM 81610	15,987	0,629	46,975	1,849	21,000	0,827

REFERENCIAS / REFERENCIAS	DIMENSIONS / DIMENSIONES					
	d		D		T	
	mm	inch	mm	inch	mm	inch
M 84249/M 84210	25,400	1,000	59,530	2,344	23,368	0,920
M 84548/M 84510	25,400	1,000	57,150	2,250	19,431	0,765
M 86647/M 86610	28,575	1,125	64,292	2,531	21,433	0,844
M 86648 A/M 86610	30,955	1,219	64,292	2,531	21,432	0,844
M 86649/M 86610	30,162	1,188	64,292	2,531	21,433	0,844
M 88043/M 88010	30,162	1,188	68,262	2,688	22,225	0,875
M 88043/M 88011	30,162	1,188	68,262	2,688	22,225	0,875
M 88046/M 88010	31,750	1,250	68,262	2,688	22,225	0,875
M 88048/M 88010	33,338	1,313	68,262	2,688	22,225	0,875
M 88048/M 88011	33,338	1,313	68,262	2,688	22,225	0,875
JHM 88540/JHM 88513	30,000	1,181	72,000	2,835	29,370	1,156
HM 88542/HM 88510	31,750	1,250	73,025	2,875	29,370	1,156
HM 88547/HM 88510	33,338	1,313	73,025	2,875	29,370	1,156
HM 88648/HM 88610	35,717	1,406	72,233	2,844	25,400	1,000
HM 88649/HM 88610	34,925	1,375	72,233	2,844	25,400	1,000
HM 89443/HM 89410	33,338	1,313	76,200	3,000	29,370	1,156
HM 89446/HM 89410	34,925	1,375	76,200	3,000	29,370	1,156
HM 89448/HM 89410	36,512	1,438	76,200	3,000	29,370	1,156
HM 89449/HM 89410	36,512	1,438	76,200	3,000	29,370	1,156
LM 102949/LM 102910	45,242	1,781	73,431	2,891	19,558	0,770
LM 102949/LM 102911	45,242	1,781	73,431	2,891	21,430	0,844
JLM 104945/JLM 104910	50,000	1,969	82,000	3,228	21,500	0,846
JLM 104946/JLM 104910	50,000	1,969	82,000	3,228	21,500	0,846
JLM 104948/JLM 104910	50,000	1,969	82,000	3,228	21,500	0,846
JLM 104948/JLM 104911	50,000	1,969	82,550	3,250	21,500	0,846
LM 104949/JLM 104910	50,800	2,000	82,000	3,228	21,976	0,865
LM 104949/JLM 104911	50,800	2,000	82,550	3,250	21,976	0,865
LM 104949/LM 104911 A	50,800	2,000	82,550	3,250	21,976	0,865
LM 104949/LM 104912	50,800	2,000	82,931	3,265	21,590	0,850
HM 204043/HM 204010	39,987	1,574	90,975	3,582	32,000	1,260
JM 205149/JM 205110	50,000	1,969	90,000	3,543	28,000	1,102
JM 205149 A/JM 205110	50,000	1,969	90,000	3,543	28,000	1,102
JM 207049/JM 207010	55,000	2,165	95,000	3,740	29,000	1,142
JM 207049 A/JM 207010	55,000	2,165	95,000	3,740	29,000	1,142
JH 211749/JH 211710	65,000	2,559	120,000	4,724	39,000	1,535
HM 212044/HM 212011	60,325	2,375	122,238	4,813	38,100	1,500
HM 212047/HM 212011	63,500	2,500	122,238	4,813	38,100	1,500
HM 212049/HM 212010	66,675	2,625	122,238	4,813	38,100	1,500
HM 212049/HM 212011	66,675	2,625	122,238	4,813	38,100	1,500
H 212749/H 212710	65,987	2,598	123,975	4,881	41,500	1,634
HM 215249/HM 215210	75,987	2,992	131,975	5,196	39,000	1,535
LL 217849/LL 217810	88,900	3,500	121,442	4,781	15,083	0,594
HM 218248/HM 218210	89,974	3,542	146,975	5,786	40,000	1,575
HM 220149/HM 220110	99,975	3,936	156,975	6,180	42,000	1,654
LL 225749/LL 225710	127,000	5,000	165,895	6,531	18,258	0,719
LM 300849/LM 300811	40,987	1,614	67,975	2,676	17,500	0,689
JHM 318448/JHM 318410	90,000	3,543	155,000	6,102	44,000	1,732

REFERENCIAS / REFERENCIAS	DIMENSIONS / DIMENSIONES					
	d		D		T	
	mm	inch	mm	inch	mm	inch
L 319249/L 319210	95,250	3,750	130,175	5,125	20,638	0,813
LL 319349/LL 319310	95,250	3,750	128,587	5,063	15,875	0,625
LM 330448/LM 330410	152,400	6,000	203,200	8,000	41,275	1,625
H 414242/H 414210	66,675	2,625	136,525	5,375	41,275	1,625
JH 415647/JH 415610	75,000	2,953	145,000	5,709	51,000	2,008
LM 501349/LM 501310	41,275	1,625	73,431	2,891	19,558	0,770
LM 501349/LM 501314	41,275	1,625	73,431	2,891	21,430	0,844
LM 503349/LM 503310	45,987	1,811	74,976	2,952	18,000	0,709
LM 503349 A/LM 503310	45,987	1,811	74,976	2,952	18,000	0,709
JLM 506849/JLM 506810	55,000	2,165	90,000	3,543	23,000	0,906
JLM 506849 A/JLM 506810	55,000	2,165	90,000	3,543	25,000	0,984
JLM 508748/JLM 508710	60,000	2,362	95,000	3,740	24,000	0,945
JM 511945/3920	65,000	2,559	112,712	4,437	29,020	1,143
JM 511945/JM 511910	65,000	2,559	110,000	4,331	28,000	1,102
JM 511946/JM 511910	65,000	2,559	110,000	4,331	28,000	1,102
HM 516449 C/HM 516410	82,550	3,250	133,350	5,250	39,688	1,563
JHM 516849/JHM 516810	85,000	3,347	140,000	5,512	39,000	1,535
HM 518445/HM 518410	88,900	3,500	152,400	6,000	39,688	1,563
L 521949/L 521910	107,950	4,250	146,050	5,750	21,433	0,844
JHM 522649/JHM 522610	110,000	4,331	180,000	7,087	47,000	1,850
JM 515649/JM 515610	80,000	3,150	130,000	5,118	35,000	1,378
LM 603049/LM 603011	45,242	1,781	77,788	3,063	19,842	0,781
LM 603049/LM 603012	45,242	1,781	77,788	3,063	21,430	0,844
LM 603049/LM 603014	45,242	1,781	79,975	3,149	19,842	0,781
JM 612949/JM 612910	70,000	2,756	115,000	4,528	29,000	1,142
L 623149/L 623110	114,300	4,500	152,400	6,000	21,432	0,844
JLM 704649/JLM 704610	50,000	1,969	84,000	3,307	22,000	0,866
JLM 710949 C/JLM 710910	65,000	2,559	105,000	4,134	24,000	0,945
L 713049/L 713010	69,850	2,750	101,600	4,000	19,050	0,750
JLM 714149/JLM 714110	75,000	2,953	115,000	4,528	25,000	0,984
JM 714249/JM 714210	75,000	2,953	120,000	4,724	31,000	1,220
H 715332/H 715311	60,325	2,375	136,525	5,375	46,038	1,813
H 715334/H 715311	61,912	2,438	136,525	5,375	46,038	1,813
H 715336/H 715311	63,500	2,500	136,525	5,375	46,038	1,813
H 715340/H 715311	65,088	2,563	136,525	5,375	46,038	1,813
H 715341/H 715311	66,675	2,625	136,525	5,375	46,038	1,813
H 715343/H 715311	68,262	2,688	136,525	5,375	46,038	1,813
H 715345/H 715311	71,438	2,813	136,525	5,375	46,038	1,813
JM 716649/JM 716610	85,000	3,347	130,000	5,118	30,000	1,181
JM 718149/JM 718110	90,000	3,543	145,000	5,709	35,000	1,378
JM 718149 A/JM 718110	90,000	3,543	145,000	5,709	35,000	1,378
JM 719149/JM 719113	95,000	3,740	150,000	5,906	35,000	1,378
JHM 720249/JHM 720210	100,000	3,937	160,000	6,299	41,000	1,614
JM 720249/JM 720210	100,000	3,937	155,000	6,102	36,000	1,417
HM 801346/HM 801310	38,100	1,500	82,550	3,250	29,370	1,156
HM 801346 X/HM 801310	38,100	1,500	82,550	3,250	29,370	1,156
M 802048/M 802011	41,275	1,625	82,550	3,250	26,543	1,045

REFERENCES / REFERENCIAS	DIMENSIONS / DIMENSIONES					
	d		D		T	
	mm	inch	mm	inch	mm	inch
HM 803145/HM 803110	41,275	1,625	88,900	3,500	30,163	1,188
HM 803146/HM 803110	41,275	1,625	88,900	3,500	30,162	1,187
HM 803149/HM 803110	44,450	1,750	88,900	3,500	30,162	1,187
HM 803149/HM 803112	44,450	1,750	92,075	3,625	30,162	1,187
M 804048/M 804010	47,625	1,875	88,900	3,500	25,400	1,000
M 804049/M 804010	47,625	1,875	88,900	3,500	25,400	1,000
HM 804840/HM804810	41,275	1,625	95,250	3,750	30,162	1,187
HM 804843/HM 804810	44,450	1,750	95,250	3,750	30,162	1,187
HM 804846/HM 804810	47,625	1,875	95,250	3,750	30,162	1,187
LM 806649/LM 806610	53,975	2,125	88,900	3,500	19,050	0,750
LM 806649/LM 806610	53,975	2,125	88,900	3,500	19,050	0,750
HM 807040/HM 807010	44,450	1,750	104,775	4,125	36,512	1,437
HM 807044/HM 807010	49,212	1,938	104,775	4,125	36,512	1,437
JHM 807045/JHM 807012	50,000	1,969	105,000	4,134	37,000	1,457
HM 807046/HM 807010	50,800	2,000	104,775	4,125	36,512	1,437
HM 807048/HM 807010	54,487	2,145	104,775	4,125	36,512	1,437
HM 807049/HM 807010	53,975	2,125	104,775	4,125	36,512	1,437
JLM 813049/JLM 813010	70,000	2,756	110,000	4,331	26,000	1,024
HM 813840/HM813811	55,562	2,188	127,000	5,000	36,512	1,437

REFERENCES / REFERENCIAS	DIMENSIONS / DIMENSIONES					
	d		D		T	
	mm	inch	mm	inch	mm	inch
HM 813841/HM 813810	60,325	2,375	127,000	5,000	36,512	1,437
HM 813841/HM 813811	60,325	2,375	127,000	5,000	36,512	1,437
HM 813842/HM 813810	63,500	2,500	127,000	5,000	36,512	1,437
HM 813843/HM 813810	61,912	2,438	127,000	5,000	36,512	1,437
HM 813849/HM 813810	71,438	2,813	127,000	5,000	36,512	1,437
HM 813849/HM 813811	71,438	2,813	127,000	5,000	36,512	1,437
L 814749/L 814710	76,200	3,000	109,538	4,313	19,050	0,750
JL 819349/JL 819310	95,000	3,740	135,000	5,315	20,000	0,787
HM 903245/HM 903210	41,275	1,625	95,250	3,750	30,958	1,219
HM 903249/HM 903210	44,450	1,750	95,250	3,750	30,958	1,219
HM 905843/HM 905810	44,987	1,771	104,986	4,133	32,512	1,280
L 910349/L 910310	63,485	2,499	94,975	3,739	17,000	0,669
HM 911244/HM 911210	59,987	2,362	130,175	5,125	34,100	1,343
HM 911244/HM 911216	59,987	2,362	134,983	5,314	33,449	1,317
HM 911245/HM 911210	60,325	2,375	130,175	5,125	36,512	1,437
H 913842/H 913810	61,912	2,438	146,050	5,750	41,275	1,625
H 913843/H 913810	61,912	2,438	146,050	5,750	41,275	1,625
H 913849/H 913810	69,850	2,750	146,050	5,750	41,275	1,625
H 924033/H 924010	101,600	4,000	214,312	8,438	55,562	2,187



01.3

SPECIAL DESIGN BEARINGS SERIE ESPECIAL

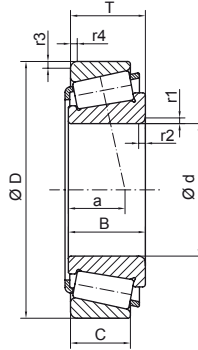

DIMENSIONS / DIMENSIONES													REFERENCES / REFERENCIAS
d		D		T		B		C		r1/r2 min	r3/r4 min	a	
mm	inch	mm	inch	mm	inch	mm	inch	mm	inch	mm	mm	mm	
22,000	0,866	41,000	1,614	14,500	0,571	14,600	0,575	11,400	0,449	1,0	1,0	10,0	F 15028
		47,000	1,850	20,750	0,817	19,500	0,768	12,000	0,472	ESP	1,5	9,8	F 15089
		47,000	1,850	20,750	0,817	20,750	0,817	11,500	0,453	ESP	1,0	9,2	F 15063
25,000	0,984	62,000	2,441	18,250	0,719	17,000	0,669	14,000	0,551	0,5	2,0	16,2	F 15001
28,000	1,102	52,000	2,047	15,750	0,620	18,500	0,728	12,000	0,472	3,5	1,5	13,0	F 15056
		67,000	2,638	20,500	0,807	20,500	0,807	16,000	0,630	0,6	0,6	14,9	F 15023
29,000	1,142	50,292	1,980	14,224	0,560	17,500	0,689	10,668	0,420	2,5	1,3	10,9	F 15029
30,000	1,181	72,000	2,835	20,750	0,817	19,000	0,748	14,000	0,551	0,5	2,0	18,4	F 15002
		72,000	2,835	24,000	0,945	23,000	0,906	16,500	0,650	0,3	1,5	20,8	F 15203
30,162	1,187	68,262	2,687	22,225	0,875	22,225	0,875	17,462	0,687	1,5	1,5	19,2	F 15079
34,925	1,375	73,025	2,875	26,988	1,063	26,975	1,062	20,000	0,787	3,5	1,5	20,2	F 15080
35,000	1,378	60,000	2,362	13,000	0,512	18,500	0,728	13,000	0,512	2,5	1,5	12,0	F 15040
		72,000	2,835	24,000	0,945	23,500	0,925	19,000	0,748	2,0	1,5	19,0	F 15197
		89,000	3,504	38,000	1,496	38,000	1,496	27,500	1,083	1,5	1,5	28,9	F 15202
		60,000	2,362	15,875	0,625	18,460	0,727	11,938	0,470	2,0	1,3	13,3	F 15036
		80,000	3,150	22,750	0,896	21,000	0,827	18,000	0,709	2,5	2,5	20,6	F 15014
38,100	1,500	65,088	2,563	18,034	0,710	21,139	0,832	13,970	0,550	ESP	1,3	13,6	F 15055/LM 29710
		90,000	3,543	35,250	1,388	33,000	1,299	27,000	1,063	2,0	1,5	27,8	F 15157
39,688	1,563	80,167	3,156	29,370	1,156	32,891	1,295	23,812	0,937	3,5	3,3	18,2	F 15109
40,000	1,575	72,000	2,835	22,500	0,886	22,000	0,866	17,700	0,697	0,6	0,3	15,5	F 15102
		90,000	3,543	28,750	1,132	39,000	1,535	22,500	0,886	ESP	ESP	26,6	F 15117
40,987	1,614	67,975	2,676	17,500	0,689	18,000	0,709	13,500	0,531	1,5	1,5	13,8	F 15003
42,000	1,654	76,000	2,992	23,812	0,937	27,500	1,083	19,750	0,778	2,0	0,8	16,2	F 15112
50,000	1,969	83,000	3,268	20,500	0,807	20,500	0,807	15,500	0,610	3,5	1,3	16,9	F 15201
		93,264	3,672	30,162	1,187	30,302	1,193	23,812	0,937	3,5	3,3	22,1	F 15054/3720
50,800	2,000	100,000	3,937	35,000	1,378	35,000	1,378	27,000	1,063	2,5	2,5	25,0	F 15047
57,165	2,251	140,000	5,512	28,250	1,112	26,150	1,030	22,000	0,866	0,8	0,5	28,0	F 15133
60,000	2,362	92,500	3,642	23,000	0,906	23,000	0,906	18,000	0,709	1,5	1,0	19,9	F 15007
		95,000	3,740	27,000	1,063	26,000	1,024	21,000	0,827	1,5	1,5	23,7	F 15088
		130,000	5,118	39,000	1,535	35,500	1,398	25,500	1,004	3,5	3,5	40,2	F 15046
		135,000	5,315	37,000	1,457	31,000	1,220	25,500	1,004	3,5	3,0	40,8	F 15158
61,913	2,438	110,000	4,331	22,000	0,866	21,996	0,866	18,824	0,741	2,5	1,3	21,1	F 10246/394 A

Assembly / Montaje

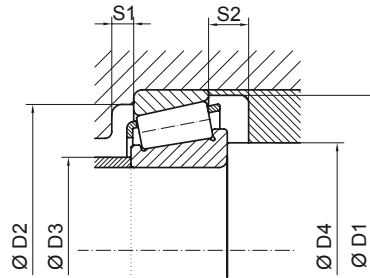

WEIGHT / PESO		ASSEMBLY / MONTAJE							LOAD / CARGA		LOAD FACTORS / FACTORES DE CARGA			SPEED / VELOCIDAD		REFERENCIAS / REFERENCIAS
		D1 min	D2 min	D2 max	D3 max	D4 min	S1	S2	Dynamic / Dinámica	Static / Estática	Dynamics / Dinámicos	Statics / Estáticos	Oil / Aceite	Grease / Grasa		
kg	lb	mm	mm	mm	mm	mm	mm	mm	C	Co	e	Y	Yo	na	ng	
0,09	0,20	38,5	36,5	40,0	25,0	21,0	3,0	3,0	22,5	25,6	0,30	1,99	1,09	12700	9400	F 15028
0,15	0,33	44,5	41,0	43,0	27,0	17,0	2,5	8,5	32,5	33,8	0,34	1,74	0,95	11300	8400	F 15089
0,15	0,33	44,5	41,0	43,0	29,0	20,0	2,5	9,0	27,1	31,9	0,43	1,39	0,77	11100	8300	F 15063
0,26	0,57	59,0	51,5	55,0	34,5	26,5	2,5	4,0	49,1	50,4	0,54	1,10	0,60	8600	6400	F 15001
0,15	0,32	50,0	45,5	48,0	31,0	32,5	2,5	3,5	34,5	43,6	0,43	1,39	0,76	9600	7100	F 15056
0,35	0,77	62,5	56,5	64,5	40,0	29,5	2,5	4,5	57,3	66,0	0,40	1,49	0,82	8100	6000	F 15023
0,12	0,26	47,5	45,0	45,0	34,0	37,0	2,5	3,6	29,7	38,2	0,37	1,62	0,89	9800	7300	F 15029
0,38	0,83	67,0	59,5	65,0	39,0	31,5	2,5	6,5	66,3	66,8	0,54	1,10	0,60	7400	5500	F 15002
0,44	0,97	66,0	55,0	66,5	38,0	31,5	6,0	7,5	60,6	62,4	0,62	0,96	0,53	7200	5400	F 15203
0,41	0,89	64,5	54,5	62,5	41,0	32,5	3,5	4,5	62,5	81,1	0,54	1,10	0,60	7600	5700	F 15079
0,51	1,12	68,5	56,5	67,5	43,0	39,0	3,5	6,5	70,5	92,2	0,54	1,10	0,60	7000	5200	F 15080
0,16	0,35	58,5	56,0	58,5	38,0	32,5	3,5	0,0	28,8	33,1	0,55	1,09	0,60	7900	5900	F 15040
0,45	0,98	67,0	56,0	66,5	42,0	42,0	6,0	5,0	64,1	83,0	0,55	1,10	0,60	7000	5200	F 15197
1,23	2,71	84,5	64,5	83,5	46,5	40,5	4,5	10,5	123,6	156,4	0,62	0,96	0,53	6000	4400	F 15202
0,19	0,41	56,5	52,5	55,0	40,5	38,0	3,5	3,5	38,7	51,6	0,42	1,44	0,79	8400	6200	F 15036
0,45	0,99	75,0	64,5	71,5	45,5	38,5	3,5	4,5	78,2	87,4	0,54	1,10	0,60	6500	4800	F 15014
0,24	0,53	61,5	58,0	60,0	44,5	40,5	3,5	4,0	47,1	62,2	0,33	1,80	0,99	7600	5600	F 15055/LM 29710
1,10	2,42	84,5	67,0	153,0	48,5	45,0	4,5	8,0	116,7	149,5	0,55	1,10	0,60	5900	4300	F 15157
0,67	1,47	75,0	69,5	69,0	48,0	44,0	4,0	5,5	104,9	125,2	0,27	2,20	1,21	6600	4900	F 15109
0,48	1,06	69,0	64,0	70,0	46,5	41,5	3,5	4,5	74,8	97,7	0,33	1,80	0,99	7000	5200	F 15102
0,96	2,11	86,0	70,5	84,5	55,0	43,0	4,5	6,0	106,0	155,0	0,61	0,98	0,54	5700	4200	F 15117
0,25	0,54	64,0	60,5	62,5	47,0	4,0	4,5	4,0	48,3	65,4	0,35	1,72	0,94	7200	5300	F 15003
0,48	1,06	72,0	67,5	72,5	49,5	45,0	5,0	4,0	80,9	107,2	0,28	2,15	1,18	6700	4900	F 15112
0,42	0,91	79,0	74,5	78,0	56,0	61,5	2,0	5,0	73,3	93,3	0,36	1,67	0,92	5800	4300	F 15201
0,84	1,85	87,5	80,0	82,0	60,5	54,5	4,5	6,0	110,3	146,5	0,33	1,77	0,97	5400	4000	F 15054/3720
1,18	2,60	96,5	85,0	94,5	62,5	54,5	4,5	8,0	150,9	207,3	0,40	1,50	0,83	5100	3800	F 15047
2,10	4,62	132,0	123,0	137,5	91,5	59,0	5,5	6,0	172,6	215,7	0,42	1,42	0,78	3900	2900	F 15133
0,50	1,10	89,5	83,0	88,5	66,0	62,5	5,5	5,0	92,0	140,0	0,38	1,55	0,85	5100	3800	F 15007
0,69	1,52	92,0	83,0	89,5	67,0	62,5	5,5	6,0	85,1	124,1	0,42	1,44	0,79	5000	3700	F 15088
2,24	4,93	124,5	98,5	118,5	72,0	64,5	5,5	13,5	191,8	238,0	0,84	0,71	0,39	3700	2700	F 15046
2,21	4,85	129,0	104,0	123,0	73,5	72,5	4,5	11,5	186,6	204,2	0,80	0,75	0,41	3600	2700	F 15158
0,87	1,90	105,0	97,5	105,0	76,5	65,0	5,5	3,0	101,1	139,3	0,40	1,49	0,82	4500	3300	F 10246/394 A

01.3

SPECIAL DESIGN BEARINGS SERIE ESPECIAL

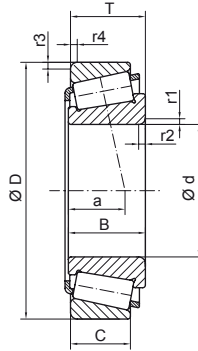

DIMENSIONS / DIMENSIONES													REFERENCES / REFERENCIAS
d		D		T		B		C		r1/r2 min	r3/r4 min	a	
mm	inch	mm	inch	mm	inch	mm	inch	mm	inch	mm	mm	mm	
62,000	2,441	122,238	4,813	43,658	1,719	43,764	1,723	34,500	1,358	1,5	3,3	34,6	F 15008/ F 15009
		147,000	5,787	50,000	1,969	47,000	1,850	33,000	1,299	1,5	3,0	46,6	F 15184
65,000	2,559	145,000	5,708	36,000	1,417	32,950	1,297	23,000	0,906	3,5	3,5	28,1	F 15082
		145,000	5,708	39,600	1,555	36,450	1,435	26,500	1,043	2,7	2,7	38,5	F 15083
		150,000	5,906	38,000	1,496	35,000	1,378	30,000	1,181	2,0	0,7	29,9	F 15119
		165,000	6,496	36,000	1,417	33,000	1,299	23,000	0,906	3,0	3,0	43,9	F 15183
		165,000	6,496	40,000	1,575	36,650	1,443	25,500	1,004	2,7	2,7	48,0	F 15159
66,675	2,625	110,000	4,331	22,000	0,866	21,996	0,866	18,824	0,741	2,5	1,3	21,1	F 10247/394 A
68,263	2,688	115,000	4,528	30,162	1,187	30,163	1,188	23,500	0,925	5,0	2,0	26,8	F 10053
70,000	2,756	120,000	4,724	29,795	1,173	29,007	1,142	24,237	0,954	2,0	2,0	25,9	484/472 + ring/casquillo
		130,000	5,118	57,000	2,244	56,000	2,205	35,000	1,378	ESP	2,5	30,0	F 15051 C
		130,000	5,118	57,000	2,244	56,000	2,205	35,000	1,378	10,5	2,5	30,0	F 15051 R
		150,000	5,906	39,800	1,567	40,000	1,575	31,700	1,248	ESP	1,2	31,1	F 15116
		150,000	5,906	41,275	1,625	39,687	1,562	25,400	1,000	2,0	3,3	45,1	F 15114
		150,000	5,906	64,000	2,520	61,000	2,402	42,000	1,654	ESP	2,5	36,5	F 15193
75,000	2,953	160,000	6,299	58,000	2,283	55,000	2,165	40,000	1,575	3,5	3,5	52,3	F 15071
		180,000	7,087	63,500	2,500	60,000	2,362	45,000	1,772	3,5	3,5	58,2	F 15048
		140,000	5,512	34,250	1,348	32,000	1,260	28,000	1,102	0,5	3,0	30,7	F 15190
76,200	3,000	110,000	4,331	19,050	0,750	19,050	0,750	15,083	0,594	1,5	1,5	23,7	L 814749/F 15010
80,000	3,150	140,000	5,512	39,250	1,545	39,250	1,545	32,000	1,260	2,5	2,0	32,9	F 15156
85,000	3,346	150,000	5,906	30,500	1,201	28,000	1,102	24,000	0,945	0,4	0,5	30,0	F 15104
88,000	3,465	140,000	5,512	32,000	1,260	32,000	1,260	24,000	0,945	2,5	2,5	30,0	F 15075
89,974	3,542	146,975	5,786	40,000	1,575	40,000	1,575	32,500	1,280	ESP	3,2	31,1	F 15115
100,000	3,937	160,000	6,299	42,000	1,654	40,000	1,575	34,000	1,339	ESP	ESP	42,0	F 15200
105,000	4,134	170,000	6,693	38,000	1,496	38,000	1,496	29,000	1,142	3,0	3,0	36,0	F 15076
109,538	4,313	158,750	6,250	23,020	0,906	21,438	0,844	15,875	0,625	5,0	3,3	36,8	F 15165

Assembly / Montaje

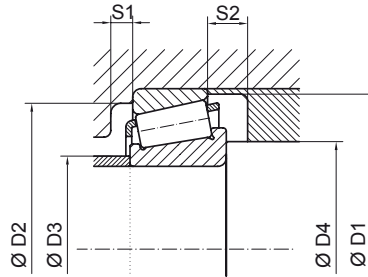

WEIGHT / PESO		ASSEMBLY / MONTAJE							LOAD / CARGA		LOAD FACTORS / FACTORES DE CARGA			SPEED / VELOCIDAD		REFERENCES / REFERENCIAS
		D1 min	D2 min	D2 max	D3 max	D4 min	S1	S2	Dynamic / Dinámica	Static / Estática	Dynamics / Dinámicos	Statics / Estáticos	Oil / Aceite	Grease / Grasa		
kg	lb	mm	mm	mm	mm	mm	mm	mm	C	Co	e	Y	Yo	na	ng	
2,25	4,95	115,5	95,5	111,5	74,0	64,5	5,5	9,0	212,3	323,4	0,49	1,22	0,67	4100	3100	F 15008 / F 15009
4,08	8,98	140,0	106,5	137,0	77,0	67,5	4,5	17,0	267,6	351,6	0,82	0,73	0,40	3300	2500	F 15184
2,48	5,45	132,5	110,0	133,5	79,5	69,5	5,5	13,0	193,1	229,3	0,82	0,72	0,40	3300	2500	F 15082
2,73	6,01	137,5	115,0	133,5	79,0	71,5	5,5	13,0	216,8	244,5	0,73	0,82	0,45	3400	2500	F 15083
3,14	6,91	140,0	129,0	149,5	89,5	63,0	5,5	8,0	244,4	294,6	0,35	1,74	0,96	3600	2700	F 15119
3,42	7,52	132,5	110,0	155,0	79,5	75,0	4,5	13,0	193,1	229,4	0,82	0,72	0,40	3000	2200	F 15183
3,86	8,48	151,0	125,5	153,5	91,5	76,7	4,5	14,5	241,4	290,4	0,82	0,73	0,40	3000	2200	F 15159
0,79	1,73	105,0	97,5	105,0	76,5	70,0	6,5	3,0	101,1	139,3	0,40	1,49	0,82	4400	3200	F 10247/394 A
1,21	2,66	111,0	100,5	108,0	81,5	74,0	6,5	6,5	140,6	218,3	0,43	1,37	0,75	4200	3100	F 10053
2,19	4,82	112,5	103,0	112,5	80,5	77,0	6,5	5,5	131,8	181,3	0,38	1,56	0,85	4100	3000	484/472 + ring/casquillo
2,69	5,92	123,5	110,5	121,5	80,0	70,0	6,5	22,0	255,0	351,5	0,33	1,80	0,99	3900	2900	F 15051 C
2,69	5,92	123,5	110,5	121,5	80,0	82,0	6,5	22,0	255,0	351,5	0,33	1,80	0,99	3900	2900	F 15051 R
3,15	6,93	140,0	128,0	145,0	89,5	77,0	6,5	8,0	247,5	294,4	0,35	1,74	0,96	3500	2600	F 15116
3,03	6,67	138,5	115,0	139,0	82,0	73,0	6,5	15,5	232,3	281,8	0,78	0,76	0,42	3200	2400	F 15114
4,80	10,56	140,0	124,0	140,5	87,0	ESP	9,0	ESP	332,5	433,7	0,35	1,74	0,96	3500	2600	F 15193
5,33	11,73	156,5	119,5	148,5	89,5	79,5	6,5	18,0	346,1	475,1	0,72	0,83	0,46	3000	2300	F 15071
7,56	16,63	173,0	132,5	168,5	94,5	79,5	6,5	18,5	432,4	566,4	0,72	0,84	0,46	2800	2100	F 15048
2,27	4,99	134,0	121,0	130,0	90,5	78,5	4,5	6,0	208,3	275,5	0,42	1,43	0,78	3600	2600	F 15190
0,58	1,28	105,0	97,5	104,5	85,0	78,5	7,0	3,5	66,4	117,6	0,50	1,19	0,65	4100	3000	L 814749/F 15010
2,50	5,50	135,5	120,5	131,0	95,0	89,5	4,5	7,0	236,6	371,4	0,41	1,48	0,81	3500	2600	F 15156
2,05	4,51	141,0	130,5	146,5	98,0	87,0	7,0	6,5	199,1	254,5	0,42	1,43	0,79	3200	2400	F 15104
1,78	3,92	134,0	12,0	134,5	100,0	91,5	8,0	8,0	187,1	302,4	0,42	1,41	0,78	3400	2500	F 15075
2,48	5,46	140,5	129,0	136,0	100,5	94,0	8,0	7,5	245,9	369,4	0,33	1,80	0,99	3300	2400	F 15115
3,13	6,89	155,0	133,5	ESP	110,0	ESP	6,5	8,0	253,1	436,3	0,53	1,14	0,63	2900	2100	F 15200
3,25	7,15	163,0	150,0	162,5	122,5	109,0	9,0	9,0	251,2	427,3	0,43	1,38	0,76	2800	2000	F 15076
1,29	2,84	149,0	139,0	147,5	120,5	125,5	4,5	7,0	114,1	187,5	0,61	0,99	0,54	2700	2000	F 15165

01.4

FLANGE SIDE BEARINGS RODAMIENTOS CON VALONA



Type A / Tipo A

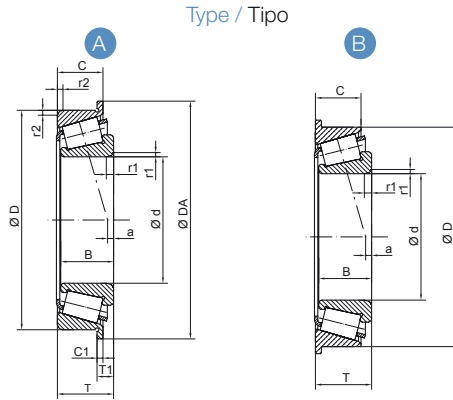

Type / Tipo

DIMENSIONS / DIMENSIONES													REFERENCES / REFERENCIAS
d		D		T		B		C		r1 min	r2 min	a	
mm	inch	mm	inch	mm	inch	mm	inch	mm	inch	mm	mm	mm	
21,986	0,866	45,000	1,772	15,600	0,614	16,637	0,655	12,065	0,475	1,30	ESP	5,30	F 15108
25,000	0,984	59,000	2,323	18,000	0,709	17,500	0,689	17,000	0,669	1,00	1,50	4,90	F 15090
		54,000	2,126	18,750	0,738	15,000	0,591	15,500	0,610	1,00	1,00	4,30	F 15196
30,162	1,187	68,262	2,687	22,225	0,875	22,225	0,875	17,463	0,688	2,30	1,50	3,00	M 88043/M 88010B
31,750	1,250	58,877	2,318	15,874	0,625	16,764	0,660	11,811	0,465	ESP	1,30	2,90	LM 67048/LM 67010 BA
		59,131	2,328	20,166	0,794	16,764	0,660	16,891	0,665	ESP	ESP	2,90	LM 67048 / LM 67010 BCE
		62,000	2,441	18,661	0,735	19,050	0,750	14,732	0,580	ESP	1,30	4,90	F 15198
40,000	1,575	80,000	3,150	19,750	0,778	18,000	0,709	16,000	0,630	2,00	2,00	3,30	30208 BF
		90,000	3,543	25,250	0,994	23,000	0,906	20,000	0,787	2,50	2,50	5,80	30308/30308 B
41,275	1,625	76,200	3,000	18,009	0,709	17,384	0,684	14,288	0,563	0,80	1,50	0,90	11163/11300 B
42,000	1,654	100,000	3,937	38,250	1,506	36,000	1,417	30,000	1,181	1,00	2,50	1,70	F 15026
45,000	1,772	90,000	3,543	32,000	1,260	29,370	1,156	29,000	1,142	4,00	2,50	4,67	JHM 803148/JHM 803113 B
		110,000	4,331	29,250	1,152	27,000	1,063	23,000	0,906	2,50	2,00	6,20	F 15161
50,000	1,969	90,000	3,543	21,750	0,856	20,000	0,787	17,000	0,669	2,00	2,00	2,20	30210 BF
50,800	2,000	104,775	4,125	36,512	1,437	36,512	1,437	28,575	1,125	3,50	3,50	7,70	HM 807046/HM 807010 BT
60,000	2,362	130,000	5,118	33,250	1,309	49,000	1,929	27,000	1,063	0,80	2,50	3,50	F 15192
60,325	2,375	127,000	5,000	44,450	1,750	44,450	1,750	34,925	1,375	3,50	3,30	9,50	65237/65500 B
65,000	2,559	110,000	4,331	34,000	1,339	34,000	1,339	26,500	1,043	3,00	2,50	8,00	33113 B
76,200	3,000	121,442	4,781	24,608	0,969	23,012	0,906	17,463	0,688	2,00	1,50	-1,50	34300/34478 B
80,000	3,150	139,992	5,511	36,513	1,438	36,098	1,421	28,575	1,125	2,50	3,50	5,80	F 15191

Type B / Tipo B

DIMENSIONS / DIMENSIONES													REFERENCES / REFERENCIAS
d		D		T		B		C		r1 min	r2 min	a	
mm	inch	mm	inch	mm	inch	mm	inch	mm	inch	mm	mm	mm	
77,000	3,031	127,990	5,039	30,600	1,205	25,000	0,984	29,997	1,181	5,0	-	0,5	L 29002/L 33492
		128,064	5,042	37,600	1,480	25,000	0,984	40,894	1,610	5,0	-	0,5	L 29002/L 29001



Type A / Tipo A

WEIGHT / PESO		OTHER DIMENSIONS / OTRAS DIMENSIONES						LOAD / CARGA		LOAD FACTORS / FACTORES DE CARGA			REFERENCES / REFERENCIAS
								Dynamic / Dinámica	Static / Estática	Dynamics / Dinámicos	Statics / Estáticos	e	
kg	lb	DA		C1		T1		C	Co				
		mm	inch	mm	inch	mm	inch	kN	kN				
0,13	0,28	51,500	2,028	3,000	0,118	6,500	0,256	27,8	34,9	0,31	1,96	1,08	F 15108
0,26	0,57	65,830	2,592	3,000	0,118	4,100	0,161	52,9	55,1	0,37	1,62	0,89	F 15090
0,21	0,46	59,000	2,323	6,000	0,236	9,250	0,364	36,0	39,4	0,37	1,60	0,88	F 15196
0,43	0,94	75,949	2,990	3,967	0,156	8,730	0,344	60,0	76,9	0,54	1,10	0,60	M 88043/M 88010B
0,18	0,39	61,600	2,425	2,770	0,109	6,833	0,269	39,3	47,5	0,41	1,45	0,80	LM 67048/LM 67010 BA
0,26	0,56	65,000	2,559	3,100	0,122	6,375	0,251	39,3	47,5	0,41	1,45	0,80	LM 67048 / LM 67010 BCE
0,26	0,56	67,600	2,661	4,000	0,157	7,938	0,313	47,6	54,3	0,35	1,71	0,94	F 15198
0,44	0,96	85,000	3,346	4,000	0,157	7,750	0,305	71,8	80,7	0,37	1,60	0,88	30208 BF
0,75	1,64	96,000	3,780	5,000	0,197	10,250	0,404	99,1	110,5	0,34	1,74	0,95	30308/30308 B
0,35	0,76	80,863	3,184	3,571	0,141	7,292	0,287	54,0	68,7	0,48	1,23	0,67	11163/11300 B
1,43	3,14	106,000	4,173	7,000	0,276	15,250	0,600	140,5	166,9	0,34	1,74	0,95	F 15026
0,96	2,11	98,000	3,858	6,000	0,236	9,000	0,354	103,4	139,6	0,54	1,10	0,60	JHM 803148/JHM 803113 B
1,39	3,05	120,000	4,724	5,750	0,226	12,000	0,472	142,8	163,4	0,34	1,74	0,95	F 15161
0,54	1,19	95,000	3,740	4,000	0,157	8,750	0,344	84,4	101,8	0,42	1,42	0,78	30210 BF
1,50	3,30	116,850	4,600	4,075	0,160	12,000	0,472	153,3	212,1	0,49	1,23	0,68	HM 807046/HM 807010 BT
2,37	5,20	137,200	5,402	6,000	0,236	12,250	0,482	200,2	230,0	0,43	1,38	0,76	F 15192
2,77	6,09	134,041	5,277	7,145	0,281	16,670	0,656	221,5	287,2	0,48	1,23	0,67	65237/65500 B
1,37	3,01	116,000	4,567	5,500	0,217	13,000	0,512	150,5	232,0	0,39	1,54	0,85	33113 B
0,97	2,13	126,106	4,965	4,763	0,188	11,907	0,469	99,4	140,9	0,45	1,33	0,73	34300 / 34478 B
2,38	5,23	149,800	5,898	6,350	0,250	14,288	0,563	189,6	283,2	0,40	1,48	0,81	F 15191

Type B / Tipo B

WEIGHT / PESO		LOAD / CARGA		LOAD FACTORS / FACTORES DE CARGA			REFERENCES / REFERENCIAS
		Dynamic / Dinámica	Static / Estática	Dynamics / Dinámicos	Statics / Estáticos		
kg	lb	C	Co	e	Y	Yo	
		kN	kN				
3,20	7,04	163,9	211,4	0,43	1,38	0,76	L 29002/L 33492
2,55	5,61	163,9	211,4	0,43	1,38	0,76	L 29002/L 29001



U-Type / Tipo U

Description

Single row tapered roller bearings are usually mounted in bearing arrangements consisting of two single bearings, thus axial loads are withstood on each side.

U-type bearings constitute an exception, since they are self-contained and unitized assemblies that can manage heavy radial loads and thrust loads in either direction

Design

The U-type bearings are compact and pre-adjusted units, enabling the following features:

- Taper inner ring with no flange in the back face.
- Taper outer ring.
- Roller grinded in both faces, contacting in inner and outer ring.
- Sheet steel cage.
- Outer washer linked to the outer ring that is fixed axially in the application.
- Multipurpose grease for life lubrication.

This bearing family is broadly used in axle applications for vehicles, as wheel bearings, where the available space becomes a system constraint. However, they are also well suited for transmission and general-use industry applications.

Descripción

Los rodamientos de rodillos cónicos de una hilera suelen ser disposiciones de rodamientos que tienen dos rodamientos simples, por lo que soportan una carga axial en ambos lados.

Los rodamientos tipo U son una excepción, ya que se pueden montar de manera individual y pueden soportar grandes cargas radiales y cargas de empuje en ambos sentidos.

Diseño

Los rodamientos tipo U son compactos y pre-ajustados, y tienen las siguientes características:

- Aro interior sin pestaña en la cara de atrás.
- Aro exterior.
- Rodillo rectificado en ambas caras, contactando en el aro exterior e interior.
- Jaula de acero.
- Arandela exterior vinculada al aro exterior y fijada axialmente en la aplicación.
- Grasa multifuncional para evitar relubricación.

Esta familia de rodamiento se usa generalmente en aplicaciones de eje para vehículos, como rodamientos de ruedas, cuando el espacio es limitado. Sin embargo, también son indicados para transmisiones y aplicaciones de usos industriales generales.

01.5

U TYPE BEARINGS RODAMIENTOS TIPO U

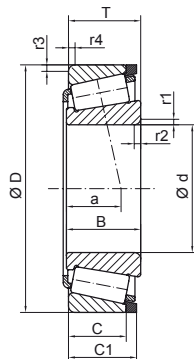

DIMENSIONS / DIMENSIONES										REFERENCES / REFERENCIAS				
d		D		T		B		C		C1		r1/r2 min	r3/r4 min	
mm	inch	mm	inch	mm	inch	mm	inch	mm	inch	mm	inch	mm	mm	
34,987	1,377	64,975	2,558	18,100	0,713	20,600	0,811	14,000	0,551	17,000	0,669	2,3	1,3	U 298/U 261 L
39,688	1,563	73,025	2,875	19,395	0,764	22,098	0,870	15,265	0,601	18,500	0,728	2,3	1,3	U 399/U 360 L
		79,967	3,148	19,395	0,764	22,098	0,870	15,265	0,601	20,091	0,791	2,3	1,3	U 399/U 365 L
44,987	1,771	79,975	3,149	24,000	0,945	26,000	1,024	18,000	0,709	22,000	0,866	2,3	1,3	U 497/U 460 L
		79,975	3,149	24,000	0,945	26,000	1,024	18,000	0,709	22,000	0,866	2,3	1,3	U 499/U 460 L

Assembly / Montaje

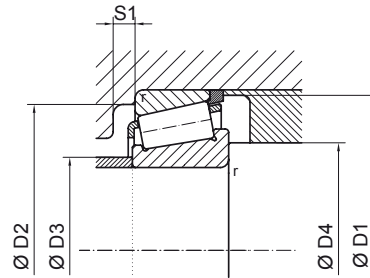

WEIGHT / PESO		ASSEMBLY / MONTAJE						LOAD / CARGA		LOAD FACTORS / FACTORES DE CARGA			REFERENCES / REFERENCIAS
		D1 min	D2 min	D3 max	D4 min	S1	S2	Dynamic / Dinámica	Static / Estática	Dynamics / Dinámicos	Statics / Estáticos	Yo	
kg	lb	mm	mm	mm	mm	mm	mm	C	Co	e	Y	Yo	
0,257	0,565	60,0	59,5	39,5	40,5	2,3	2,0	49,2	58,2	0,32	1,88	1,04	U 298/U 261 L
0,357	0,785	68,0	67,5	44,5	46,0	2,3	2,0	57,6	72,6	0,32	1,88	1,04	U 399/U 360 L
0,431	0,948	68,0	67,5	44,5	46,0	2,3	2,0	57,6	72,6	0,32	1,88	1,04	U 399/U 365 L
0,478	1,052	74,5	74,5	50,0	52,0	2,3	2,5	76,5	92,0	0,32	1,88	1,04	U 497/U 460 L
0,478	1,052	74,5	74,5	50,0	52,0	2,3	2,5	76,5	92,0	0,32	1,88	1,04	U 499/U 460 L

01.6

STEERING BEARINGS RODAMIENTOS DE DIRECCIÓN

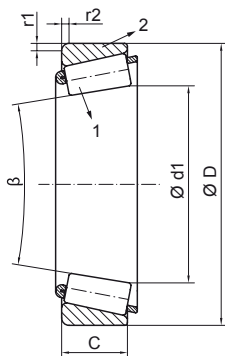

DIMENSIONS / DIMENSIONES								WEIGHT / PESO		POSITION / POSICIÓN	REFERENCES / REFERENCIAS
d1		D		C		r1/r2 min	β	kg	lb		
mm	inch	mm	inch	mm	inch	mm	mm				
*		44,450	1,750	9,525	0,375	1,5	*	0,036	0,079	2	6
*		49,146	1,935	19,050	0,750	Esp.	*	0,128	0,282	2	6 CE
*		49,225	1,938	11,509	0,453	1,5	*	0,055	0,121	2	13 C
*		57,092	2,248	17,094	0,673	2,0	*	0,173	0,381	2	14 XS
28,313	1,115	*	*	*	*	*	25° 24'	0,022	0,048	1	5 BC
33,297	1,311	*	*	*	*	*	29° 58'	0,030	0,066	1	11 BC
43,655	1,719	*	*	*	*	*	31° 52'	0,062	0,136	1	35 BC



01.7

INNER RINGS CONJUNTOS INTERIORES

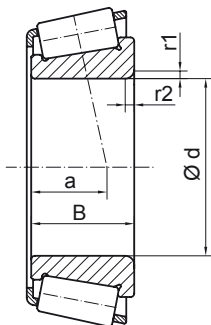

DIMENSIONS / DIMENSIONES						REFERENCES / REFERENCIAS
d		B		r1/r2 min	a	
mm	inch	mm	inch	mm	mm	
24,000	0,945	28,500	1,122	1,00	11,50	F 15084
28,000	1,102	32,000	1,260	2,50	9,90	F 15101
32,000	1,260	29,500	1,161	0,80	11,80	F 15110
38,100	1,500	29,771	1,172	0,80	8,50	F 15131
40,000	1,575	38,000	1,496	2,50	15,00	F 15150
45,000	1,772	30,045	1,183	2,50	7,00	F 15132
50,000	1,969	41,275	1,625	0,80	14,60	F 15113
55,000	2,165	29,800	1,173	1,50	7,10	F 15111
65,000	2,559	31,000	1,220	0,50	3,50	F 15134



WEIGHT / PESO		ASSEMBLY / MONTAJE		LOAD / CARGA		LOAD FACTORS / FACTORES DE CARGA			REFERENCES / REFERENCIAS
				Dynamic / Dinámica	Static / Estática	Dynamic / Dinámicos	Statics / Estáticos		
kg	lb	DA	C1	C	Co	e	Y	Yo	
		mm	mm	kN	kN				
0,19	0,42	30,0	28,0	70,5	81,0	0,23	2,60	1,43	F 15084
1,16	2,55	56,0	35,5	128,3	162,5	0,33	1,80	0,99	F 15101
0,42	0,91	42,0	35,0	99,6	116,5	0,26	2,27	1,25	F 15110
0,41	0,90	46,5	41,5	94,7	114,9	0,36	1,64	0,90	F 15131
0,67	1,47	49,5	49,5	144,3	185,4	0,28	2,11	1,16	F 15150
0,95	2,09	68,0	53,5	139,5	182,4	0,33	1,80	0,99	F 15132
1,18	2,59	65,0	53,5	164,3	197,9	0,40	1,48	0,82	F 15113
0,70	1,54	65,0	60,5	130,2	155,2	0,34	1,79	0,98	F 15111
1,40	3,08	85,5	67,5	186,0	250,8	0,43	1,38	0,76	F 15134

02

Double row tapered roller bearings

Rodamientos cónicos de doble hilera

02.0	Technical introduction / Introducción técnica	166
02.1	Double row tapered roller bearings / Rodamientos cónicos de doble hilera	170



Product overview / Introducción

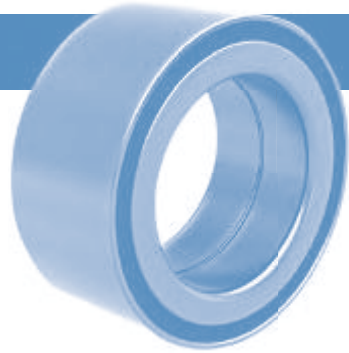

Description

Double row tapered roller bearings can accommodate high radial loads as well as high axial loads, in both directions. They provide stiff bearing arrangements and are suitable for bearings arrangements where rigid axial guidance is required.

Advantages:

- Universal application.
- High radial and axial load carrying capacity in both direction.
- Space-saving construction.
- Defined clearance.
- Lubricated for life.

Double row tapered roller bearings as well as other Fersa bearings are designed to comply with the highest working standards, since bearing counts on totality of production process that enables us to offer highest quality bearings for European and worldwide automotive market.

Design

Double row tapered roller bearings are units with robust inner and outer rings, rollers and plastic or steel cages.

They correspond to a pair of single row tapered roller bearing in "O" arrangement, but take up less space.

Descripción

Los rodamientos de rodillos cónicos de doble hilera pueden soportar grandes cargas radiales y axiales en ambos sentidos. Permiten disposiciones de rodamientos rígidos, y son indicados para disposiciones de rodamientos donde se requiere una guía axial rígida.

Ventajas:

- Aplicaciones universales.
- Alta capacidad de carga radial y axial en ambos sentidos.
- Construcción para ahorrar espacio.
- Lubricados para la vida del rodamiento.

Los rodamientos de rodillos cónicos de doble hilera, así como otros rodamientos de Fersa Bearings están diseñados para soportar condiciones extremas de trabajo, siendo los rodamientos utilizados por principales fabricantes del mercado del automóvil europeo y mundial.

Diseño

Los rodamientos de rodillos cónicos de doble hilera son unidades con aros interiores y exteriores robustos, rodillos y jaulas de acero o plástico.

Corresponden a un par de rodamientos de rodillos cónicos de una hilera en disposición "O", pero ocupan menos espacio.

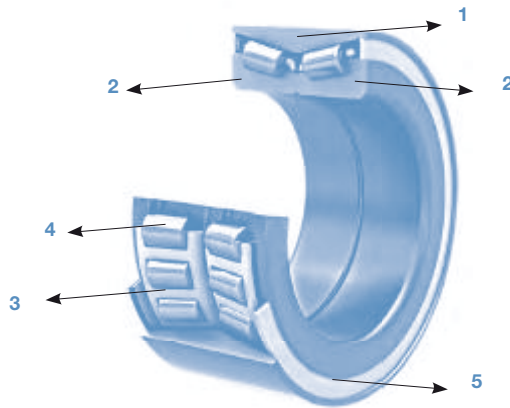

- 1 Outer Ring
- 2 Inner Ring
- 3 Cage
- 4 Roller
- 5 Seal

- 1 Aro exterior
- 2 Aro interior
- 3 Jaula
- 4 Rodillo
- 5 Retén

These bearings have approximately a 25° contact angle and are available in open and sealed designs. Sealed bearings are lubricated for life, are maintenance-free and permit particularly bearings arrangements.

Double row tapered roller bearings units with tapered rollers as rolling elements are adjusted for high axle load and acceleration and they are constructed with lubrication for life and defined preload.

Double row tapered roller bearings from Fersa are special bearings and belong to series F15000.

Estos rodamientos tienen un ángulo de contacto aproximado de 25° y están disponibles con o sin retenes. Los rodamientos con reten están lubricados para toda la vida del rodamiento, no requieren mantenimiento y permiten disposiciones particulares de rodamientos.

Los rodamientos de rodillos cónicos de doble hilera son unidades con rodillos cónicos como elementos de rotación y están ajustados para una carga axial grande y para la aceleración; están fabricados con una lubricación de por vida y para una carga determinada.

Los rodamientos cónicos de doble hilera de Fersa son rodamientos especiales y pertenecen a la serie F15000.

Bearing features / Características del rodamiento

Bearing tolerances

Double row tapered roller bearings are produced according to normal tolerances. The values for tolerances correspond to ISO 492:2002.

Tolerancia del rodamiento

Los rodamientos de rodillos cónicos de doble hilera se fabrican según las tolerancias normales. Los valores corresponden a la Normativa ISO 492:2002.

Normal tolerances for radial bearings / Tolerancias para rodamientos radiales normales

Bore diameter / Diámetro interior

d		Δ_{dmp}		V_{Dp}	V_{dmp}	Δ_{Bs}		K_{ia}	Δ_{Ts}	
over	incl	high	low	max	max	high	low	max	high	low
mm		μm		μm	μm	μm		μm	μm	
10	18	0	-12	12	9	0	-120	15	100	0
18	30	0	-12	12	9	0	-120	18	100	0
30	50	0	-12	12	9	0	-120	20	100	0
50	80	0	-15	15	11	0	-150	25	100	0
80	120	0	-20	20	15	0	-200	30	100	-100
120	180	0	-25	25	19	0	-250	35	150	-150
180	250	0	-30	30	23	0	-300	50	150	-150

Double row tapered roller bearings can also be produced with non-standard tolerances, according to their specific application.

Misalignment

Inaccuracies in the alignment of bearing locations must be taken into account. Misalignment arises when housing bores are not machined in one set. Angular misalignment of inner ring and outer ring axes are caused by larger shaft deflections and housing deformations.

Tapered roller bearings have a small aligning capability. The cross-shape of the rollers and raceways means the material stressing in rolling contact areas is still so uniform that, with the aligning angle indicated, the nominal life is not affected.

Any other misalignment of the bearing rings will result in a higher noise during operation.

Internal clearance

Bearing clearance is the measurement by which one bearing ring can be displaced in relation to the other in radial or axial direction from one end position to the other.

Internal clearance for non standard double row tapered roller bearings is normally defined according to application. Depending on the application the internal clearance could be between 30 and 200 μm .

Los rodamientos de rodillos cónicos también se pueden fabricar con tolerancias especiales, de acuerdo con la aplicación específica.

Desalineación

Las imprecisiones de alineación de la posición del rodamiento deben tenerse en cuenta. La desalineación ocurre cuando los calibres de las jaulas no están mecanizados en un conjunto. La desalineación angular de los ejes del aro interior y exterior se debe a desviaciones de ejes mayores y a las deformaciones de las cajas.

Los rodamientos de rodillos cónicos tienen una capacidad de desalineación pequeña. La forma en cruz de los rodillos y de las pistas de rodadura implica que el material tensor en las áreas de rotación de contacto se mantiene tan uniforme, que con el ángulo de alineación indicado, la vida útil del rodamiento no se verá afectada.

Cualquier otra desalineación del rodamiento resultará en un aumento del ruido durante su funcionamiento.

Juego interno

El juego del rodamiento es la distancia a través de la cual un rodamiento puede desplazarse en relación al otro en el sentido axial o radial desde la posición en un extremo al otro.

El juego interno para los rodamientos de rodillos cónicos de doble hilera fuera del estándar se define de acuerdo a la aplicación. Dependiendo de la aplicación el juego interno puede estar entre 30 and 200 μm .

Variables as fitting tolerances and mounting torque during assembly are essential to assure that the bearing will reach optimum performance under operation.

Double row tapered roller bearings usually have an axial internal clearance which is appropriate to a specific application. However, bearing components must be mounted in the prescribed order.

Speed

The maximum operating speed of double row tapered roller bearings may be limited by several criteria. Most frequently, the decisive criteria is the operating temperature, which rises with increasing speed. Other criteria for permissible operating speed may be an unreliable lubricant supply of rolling and sliding contact areas due to strong centrifugal forces or greatly changed rolling kinematics of the rolling elements.

Cages

Double row tapered roller bearings are fitted with two injection molded snap-type cages of glass fibre reinforced polyamide 66 which are heat-stabilized. They are suitable for operating temperatures of up to 120°C.

They can also be fitted with cages from stamped steel DC03.

Equivalent dynamic bearing load

$$P = F_r + Y_1 F_a \quad \text{cuando } F_a / F_r \leq e$$

$$P = 0,67 F_r + Y_2 F_a \quad \text{cuando } F_a / F_r > e$$

P= equivalent dynamic bearing load [N]

Fr= radial dynamic bearing load [N]

F_a= axial dynamic bearing load [N]

Equivalent static bearing load

$$P_0 = F_r + Y_0 F_a$$

P₀= equivalent static bearing load [N]

Fr= radial static bearing load [N]

F_a= axial static bearing load [N]

Variables como tolerancias de ajuste y torsión de montaje son esenciales para asegurar que el rodamiento funcionará al máximo cuando este operativo.

Los rodamientos de rodillos cónicos suelen tener un juego axial interno adecuado a una aplicación específica. Sin embargo los componentes de los rodamientos deben montarse en el orden prescrito.

Velocidad

La velocidad máxima operativa de los rodamientos de rodillos cónicos de doble hilera se puede ver limitada por varios criterios. Por regla general el criterio decisivo es la temperatura funcional, que aumenta con la velocidad. Otros criterios de velocidad pueden ser una cantidad de lubricante de rotación y de deslizamiento incierta debido a importantes fuerzas centrífugas o cambios importantes de rotación de viscosidad cinemática de los elementos de rotación.

Jaulas

Los rodamientos de rodillos cónicos se ajustan con dos jaulas de poliamida 66 reforzada de fibra de vidrio moldeada por inyección, y están estabilizados con calor. Son indicadas para ser utilizados en temperaturas de hasta 120°C.

También pueden ser ajustadas con jaulas de chapa de acero DC03.

Carga dinámica equivalente de rodamiento

$$P = F_r + Y_1 F_a \quad \text{cuando } F_a / F_r \leq e$$

$$P = 0,67 F_r + Y_2 F_a \quad \text{cuando } F_a / F_r > e$$

P= carga dinámica equivalente de rodamiento [N]

Fr= carga radial dinámica de rodamiento [N]

F_a= carga axial dinámica de rodamiento [N]

Carga estática equivalente de rodamiento

$$P_0 = F_r + Y_0 F_a$$

P₀= carga estática equivalente de rodamiento [N]

Fr= carga radial estática de rodamiento [N]

F_a= carga axial estática de rodamiento [N]



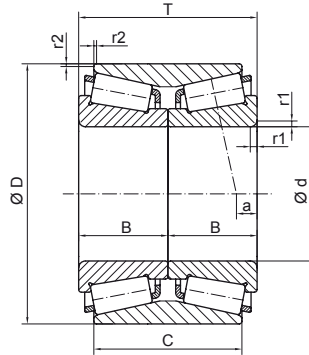
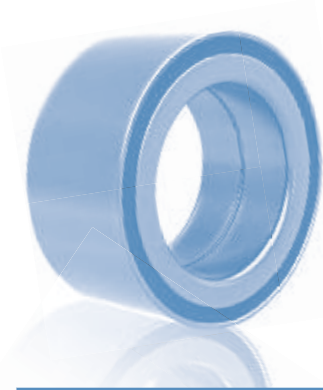

DIMENSIONS / DIMENSIONES												REFERENCES / REFERENCIAS
d		D		T		B		C		r1 min	r2 min	
mm	inch	mm	inch	mm	inch	mm	inch	mm	inch	mm	mm	
25,000	0,984	52,000	2,047	37,000	1,457	18,500	0,728	37,000	1,457	2,0	0,3	F 15041
		52,000	2,047	37,000	1,457	18,500	0,728	37,000	1,457	2,0	0,3	F 15050
		52,000	2,047	43,000	1,693	18,500	0,728	43,000	1,693	0,6	0,3	F 15042
		55,000	2,165	43,000	1,693	21,500	0,846	43,000	1,693	0,6	0,3	F 15043
		55,000	2,165	45,000	1,772	22,500	0,886	45,000	1,772	2,0	0,3	F 15175
27,000	1,063	52,000	2,047	50,000	1,969	25,000	0,984	45,000	1,772	3,2	0,6	F 15151
		53,000	2,087	43,000	1,693	21,500	0,846	43,000	1,693	2,0	0,3	F 15128
29,000	1,142	53,000	2,087	37,000	1,457	18,500	0,728	37,000	1,457	2,5	1,0	F 15067
35,000	1,378	68,000	2,677	48,000	1,890	24,000	0,945	48,000	1,890	1,0	0,5	F 15173
		65,000	2,559	35,000	1,378	17,500	0,689	35,000	1,378	1,8	0,3	F 15044
39,000	1,535	68,000	2,677	37,000	1,457	18,500	0,728	37,000	1,457	3,8	0,3	F 15045
40,000	1,575	73,000	2,874	55,000	2,165	27,500	1,083	55,000	2,165	4,0	1,0	F 15187
		75,000	2,953	50,000	1,969	25,000	0,984	50,000	1,969	5,0	0,5	F 15129
41,000	1,614	68,000	2,677	40,000	1,575	20,000	0,787	35,000	1,378	3,2	0,8	F 15015
42,000	1,654	80,000	3,150	38,000	1,496	19,000	0,748	38,000	1,496	1,5	0,5	F 15130
43,000	1,693	77,000	3,031	45,500	1,791	22,750	0,896	41,500	1,634	3,5	0,5	F 15160
45,300	1,783	80,000	3,150	48,000	1,890	24,000	0,945	48,000	1,890	3,0	0,3	F 15174
49,000	1,929	84,000	3,307	43,000	1,693	21,500	0,846	43,000	1,693	3,5	0,5	F 15167
		84,000	3,307	48,000	1,890	24,000	0,945	48,000	1,890	2,5	0,3	F 15168
		84,000	3,307	48,000	1,890	24,000	0,945	48,000	1,890	2,8	0,5	F 15068
55,000	2,165	90,000	3,543	52,000	2,047	26,000	1,024	41,000	1,614	1,5	0,5	F 15024
		93,000	3,661	51,000	2,008	23,000	0,906	40,000	1,575	2,0	0,8	F 15062
		93,000	3,661	51,200	2,016	23,000	0,906	40,000	1,575	3,5	0,5	F 15166
		100,000	3,937	52,388	2,063	21,946	0,864	42,862	1,687	2,3	0,8	385 / 384 D
70,000	2,756	120,000	4,724	60,000	2,362	29,950	1,179	60,000	2,362	2,0	0,2	F 15030



WEIGHT / PESO		LOAD / CARGA		LOAD FACTORS / FACTORES DE CARGA						REFERENCES / REFERENCIAS
		Dynamic / Dinámica	Static / Estática	Dynamics / Dinámicos					Statics / Estáticos	
kg	lb	C	Co	e	Xk	Y1	X	Y2	Yo	
		kN	kN							
0,363	0,799	64,9	86,0	0,37	1,00	1,80	0,67	2,68	1,76	F 15041
0,363	0,799	64,9	86,0	0,37	1,00	1,80	0,67	2,68	1,76	F 15050
0,410	0,902	64,9	86,0	0,37	1,00	1,80	0,67	2,68	1,76	F 15042
0,495	1,089	79,6	106,8	0,37	1,00	1,80	0,67	2,68	1,76	F 15043
0,600	1,320	80,9	103,4	0,34	1,00	1,96	0,67	2,92	1,92	F 15175
0,500	1,100	58,6	81,8	0,42	1,00	1,61	0,67	2,44	1,58	F 15151
0,405	0,891	54,5	81,6	0,37	1,00	1,80	0,67	2,68	1,76	F 15128
0,345	0,759	49,0	69,2	0,37	1,00	1,83	0,67	2,72	1,79	F 15067
0,800	1,760	111,8	160,4	0,41	1,00	1,65	0,67	2,45	1,62	F 15173
0,508	1,118	72,2	95,0	0,43	1,00	1,57	0,67	2,33	1,53	F 15044
0,522	1,148	69,1	103,7	0,47	1,00	1,43	0,67	2,13	1,40	F 15045
0,975	2,145	105,0	174,4	0,39	1,00	1,74	0,67	2,59	1,70	F 15187
0,950	2,090	98,5	151,4	0,49	1,00	1,38	0,67	2,06	1,36	F 15129
0,500	1,100	81,7	128,5	0,35	1,00	1,93	0,67	2,88	1,89	F 15015
0,830	1,826	104,2	142,6	0,37	1,00	1,47	0,67	2,19	1,44	F 15130
0,855	1,881	104,5	165,0	0,58	1,00	1,17	0,67	1,74	1,14	F 15160
1,100	2,420	107,7	175,8	0,39	1,00	1,72	0,67	2,56	1,68	F 15174
1,000	2,200	112,8	176,8	0,48	1,00	1,41	0,67	2,10	1,38	F 15167
1,000	2,200	109,4	183,8	0,41	1,00	1,62	0,67	2,42	1,59	F 15168
1,040	2,288	114,5	183,8	0,46	1,00	1,47	0,67	2,19	1,44	F 15068
1,215	2,673	155,2	265,0	0,40	1,00	1,65	0,67	2,46	1,62	F 15024
1,310	2,882	155,0	267,5	0,40	1,00	1,66	0,67	2,47	1,62	F 15062
1,400	3,080	155,0	267,5	0,40	1,00	1,66	0,67	2,47	1,62	F 15166
1,470	3,234	149,0	218,0	0,35	1,00	1,91	0,67	2,84	1,86	385 / 384 D
2,804	6,169	198,8	360,8	0,43	1,00	1,55	0,67	2,31	1,51	F 15030

03

Thrust tapered roller bearings

Rodamientos axiales cónicos

03.0	Technical introduction / Introducción técnica	174
03.1	Thrust tapered roller bearings / Rodamientos axiales cónicos	178

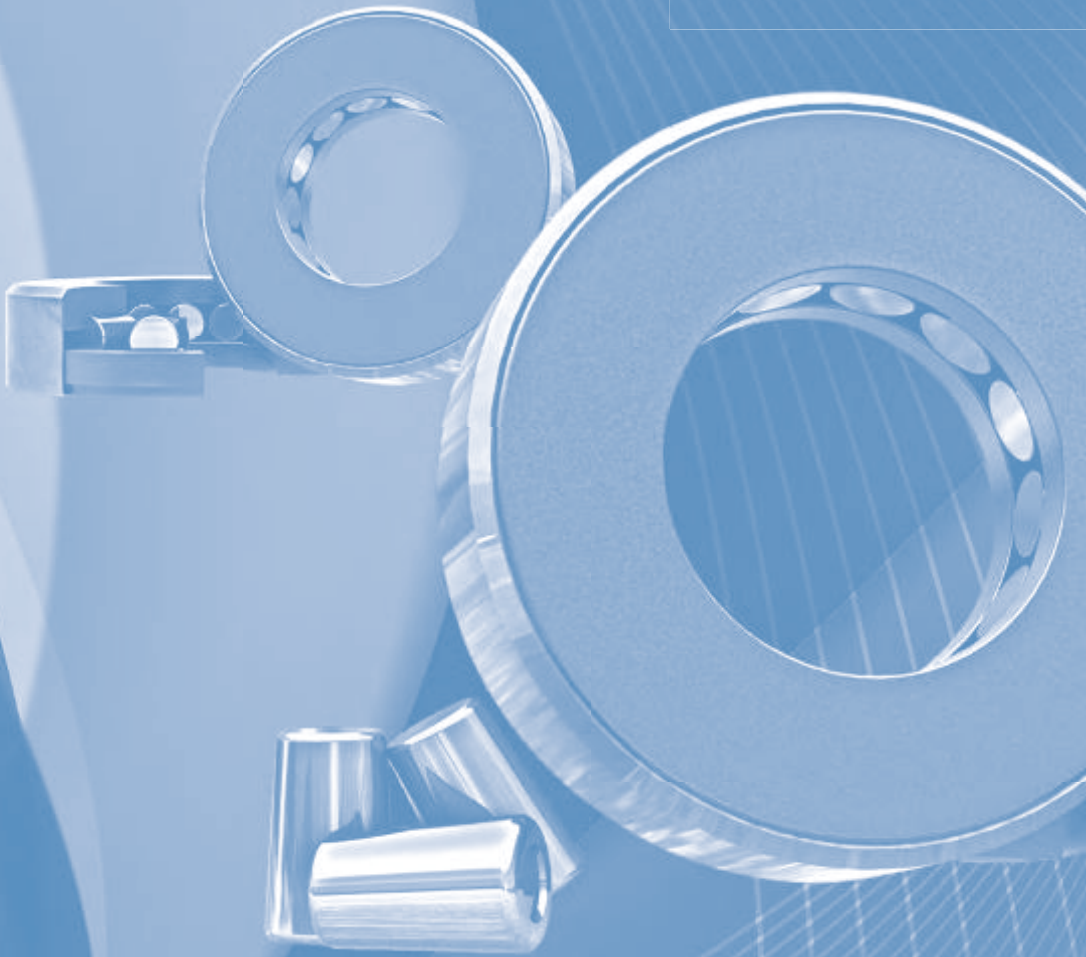

Product overview / Introducción

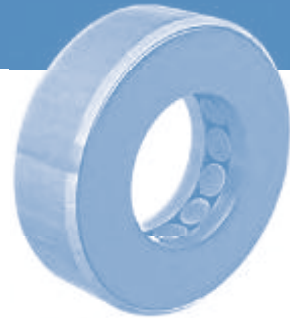

Description

Tapered roller thrust bearings, also known as T type bearings, enable axially very compact bearing arrangements to be produced, which can withstand very heavy axial loads, these bearings are insensitive to shock and stiff.

Fersa Bearings produces three types of tapered roller thrust bearings:

- Type A class, intended for low speed and thrust loads.
- Type B class, intended for applications where full rotation is not required.
- Type C class, designed for high thrust loads and high speeds.

Design

In the design of T-type bearings, the extensions of the raceways and rollers converge at a common point at the bearing center, to ensure a true rolling movement.

The Type A bearings has the following features:

- Two thrust-race rings.
- Full complement of rollers, short length and big angle.
- Sheet-steel retainer.
- Retainer holds the components during the handling and assembly in the application.
- Multipurpose grease for life lubrication.

Descripción

Los rodamientos axiales de rodillos cónicos, también conocidos como Rodamientos tipo T, permiten disposiciones axiales muy compactas, capaces de soportar cargas axiales grandes. Son rodamientos muy rígidos e insensibles al impacto.

Fersa Bearings produce tres tipos de rodamientos axiales de rodillos cónicos:

- Clase tipo A, para una velocidad baja y cargas de empuje.
- Clase tipo B, para aplicaciones donde no se requiere una rotación completa.
- Clase tipo C, diseñados para cargas grandes de empuje y para velocidades altas.

Diseño

En el diseño del rodamiento tipo T, las extensiones de las pistas y rodillos convergen en un punto común en el centro del rodamiento, para asegurar un movimiento real de rodadura.

El rodamiento tipo A tiene las siguientes características:

- Dos aros con pistas axiales.
- Conjunto de rodillos, de medida corta y ángulo grande.
- Tapa de acero o chapa.
- La tapa mantiene unidos los componentes durante el manejo y el montaje en la aplicación.
- Grasa que evita relubricación multifuncional.

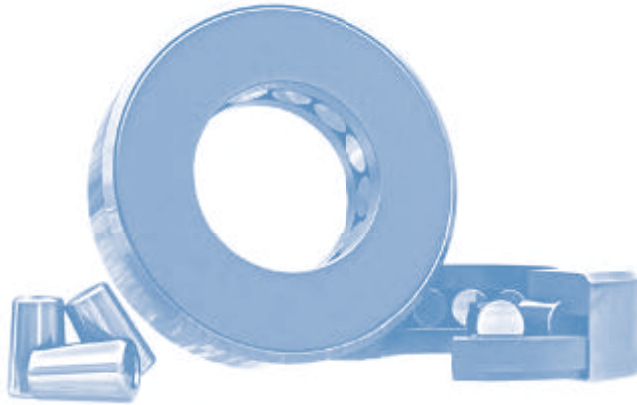

The Type A bearings are well suited for applications with oscillating motion, very low speed and heavily loaded.

The Type B bearings are determined by:

- Two thrust-race rings.
- Set of rollers, short length and small angle.
- Cage.
- Sheet-steel retainer.
- Retainer holds the components during the handling and assembly in the application.
- Multipurpose grease for life lubrication.

The Type B bearings are massively applied on automotive steering pivots and industrial applications where incomplete rotation happens.

The Type C bearings are defined by:

- Two thrust-race rings.
- Set of rollers, longer than both TTC and TTSP types.
- Cage.
- Separable design.
- Multipurpose grease for life lubrication.

The Type C bearings are basically adequate for industrial applications, where high axial loads and heavy shock must be resisted.

Los rodamientos tipo A estan indicados para aplicaciones de movimiento oscilante, velocidad muy baja y con mucha carga.

Los rodamientos tipo B tienen las siguientes características:

- Dos aros con pistas axiales.
- Un conjunto de rodillos, de longitud corta y pequeño ángulo.
- Jaula.
- Tapa de acero-chapa.
- La tapa mantiene unido los componentes durante el manejo y el montaje en la aplicación.
- Grasa multifuncional que evita relubricación.

Los rodamientos tipo B se aplican de manera general en aplicaciones de pivote de dirección de automoción y aplicaciones industriales donde se produce una rotación incompleta.

Las características de los rodamientos tipo C son:

- Dos aros con pistas axiales.
- Un conjunto de rodillos, más largos que los tipos A y B.
- Jaula.
- Diseño separable.
- Grasa multifuncional que evita relubricación.

Los rodamientos tipo C son indicados para aplicaciones sobre todo industriales, donde se deben soportar grandes cargas axiales y fuertes impactos.



Examples of those applications are boring mill tables and plastic extruder drive.

Ejemplos de esas aplicaciones son mesas de perforación y extrusoras de plástico.

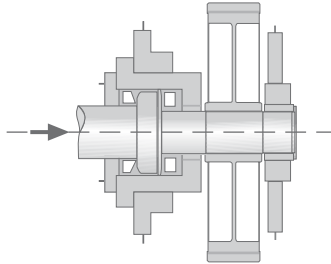

Bearing features / Características del rodamiento

Tolerances

The bore and outside diameter of Fersa tapered roller thrust bearings type A are produced with the following tolerances:

Tolerancias

Los diámetros interior y exterior de los rodamientos axiales de rodillos cónicos tipo A de Fersa. Se fabrican con las siguientes tolerancias:

Bore diameter / Diámetro interior

d		Δ_{dmp}	
over	incl	high	low
mm		μm	
-	25,400	76	-76
25,400	76,200	102	-102
76,200	-	127	-127

Outer diameter/ Diámetro exterior

D		Δ_{Dmp}	
over	incl	high	low
mm		μm	
-	127	254	0
127,000	203,200	381	0
203,200	-	508	0

Bearing width /

Anchura de rodamiento

d		Δ_{Ts}	
over	incl	high	low
mm		μm	
-	76,200	254	0
76,200	127,000	381	0
127,000	-	508	0

For types B and C tolerances are according to class 2, as follows:

Para tipos B y C las tolerancias son según la clase 2, como se detalla a continuación:

Bore diameter / Diámetro interior

d		Δ_{dmp}			
		Class 2		Class 3	
over	incl	high	low	high	low
mm		μm		μm	
-	304,800	25	0	13	0
304,800	609,600	51	0	25	0
609,600	914,400	76	0	38	0

Outer diameter/ Diámetro exterior

D		Δ_{Dmp}			
		Class 2		Class 3	
over	incl	high	low	high	low
mm		μm		μm	
-	304,800	25	0	13	0
304,800	609,600	51	0	25	0
609,600	914,400	76	0	38	0

Bore diameter / Diámetro interior

d		Δ_{Ts}			
		Class 2		Class 3	
over	incl	high	low	high	low
mm		μm		μm	
-	76,200	381	-381	203	-203
76,200	127,000	381	-381	203	-203
127,000	-	381	-381	203	-203

To achieve satisfactory operation, tapered roller thrust bearings, must always be subjected to a given minimum load, particularly if they are to operate at high speeds or are subjected to high accelerations or rapid changes in the direction of load

Misalignment

No misalignment is allowable with these bearings

Cages

Thrust taper roller bearings not featuring full complement of rollers are supplied with

- Steel pressed window-type cage

Equivalent dynamic bearing load

For single direction tapered roller thrust bearings which are subjected to purely axial dynamic loads

$$P = F_a$$

Equivalent static bearing load

Thrust roller bearings with $\alpha=90^\circ$ can support axial loads only. The static equivalent axial load for this type or bearing is given by the equation:

$$P_{0a} = F_a$$

Para lograr un funcionamiento satisfactorio, los rodamientos axiales de rodillos cónicos, deben estar siempre sometidos a una cierta carga mínima, sobre todo si deben de funcionar a velocidades altas o están sometidos a aceleraciones altas o a cambios rápidos en cuanto al sentido de la carga.

Desalineación

No se permite la desalienación en estos rodamientos

Jaulas

De rodillos cónicos que no llevan todos los complementos de rodillos se suministran con

- Jaulas tipo ventana de acero prensado

Carga dinámica equivalente de rodamiento

Para rodamientos axiales de rodillo cónico de una dirección que están sometidos a una carga dinámica axial pura

$$P = F_a$$

Carga estática equivalente de rodamiento

Los rodamientos axiales de rodillos cónicos con $\alpha=90^\circ$ son exclusivamente para carga axial. La carga estática equivalente para este tipo de rodamiento para bien dada por la ecuación

$$P_{0a} = F_a$$



03.1

THRUST TAPERED ROLLER BEARINGS RODAMIENTOS AXIALES CÓNICOS

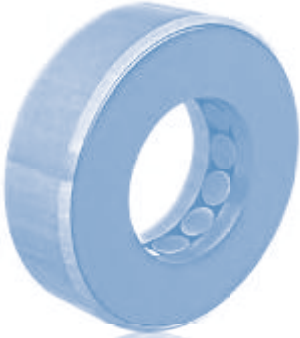

Type / Tipo

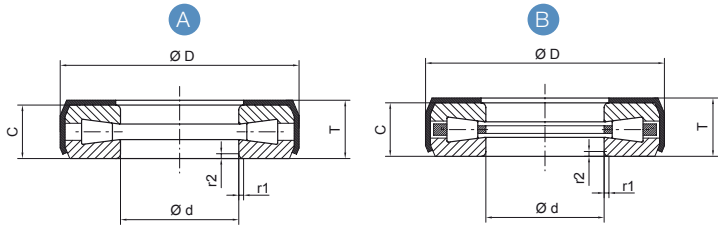

DIMENSIONS / DIMENSIONES							TYPE / TIPO	REFERENCES / REFERENCIAS
d		D		T		r1 min		
mm	inch	mm	inch	mm	inch	mm		
24,054	0,947	48,021	1,891	15,088	0,594	0,8	A	T 94
25,654	1,010	50,800	2,000	15,875	0,625	0,8	A	T 101
28,829	1,135	55,562	2,187	15,875	0,625	0,8	A	T 113
30,416	1,197	55,562	2,187	15,875	0,625	0,8	A	T 119
32,004	1,260	55,562	2,187	15,875	0,625	0,8	A	T 126
35,179	1,385	58,738	2,313	15,875	0,625	0,8	A	T 139
		66,675	2,625	19,446	0,766	0,8	B	T 138
36,754	1,447	66,675	2,625	19,446	0,766	1,5	B	T 144
38,303	1,508	65,883	2,594	19,431	0,765	0,8	A	T 149
38,354	1,510	72,619	2,859	20,638	0,813	0,8	B	T 152
		72,619	2,859	21,433	0,844	0,8	B	T 151
41,529	1,635	72,619	2,859	21,433	0,844	0,8	B	T 163
45,000	1,772	73,000	2,874	20,000	0,787	0,8	B	T 177
46,279	1,822	82,956	3,266	23,812	0,937	0,8	B	T 182
50,800	2,000	109,538	4,313	22,225	0,875	2,0	A	T 200
		109,538	4,313	22,225	0,875	2,0	A	T 200 A
51,054	2,010	74,612	2,937	15,875	0,625	0,8	A	T 199

WEIGHT / PESO		LOAD / CARGA		REFERENCES / REFERENCIAS
		Dynamic / Dinámica	Static / Estática	
kg	lb	C	Co	
		kN	kN	
0,110	0,242	55,0	88,9	T 94
0,130	0,286	59,5	99,0	T 101
0,145	0,319	63,6	109,6	T 113
0,140	0,308	63,2	109,7	T 119
0,140	0,308	63,3	109,8	T 126
0,145	0,319	67,5	120,2	T 139
0,290	0,638	129,7	286,4	T 138
0,270	0,594	128,8	285,5	T 144
0,240	0,528	80,7	139,4	T 149
0,350	0,770	144,3	318,4	T 152
0,365	0,803	144,3	318,4	T 151
0,350	0,770	137,8	308,5	T 163
0,320	0,704	145,8	317,5	T 177
0,495	1,089	195,3	441,8	T 182
0,965	2,123	196,8	322,0	T 200
1,050	2,310	280,0	806,0	T 200 A
0,200	0,440	62,2	126,6	T 199



04

Deep groove ball bearings

Rodamientos radiales de bolas

04.0	Technical introduction / Introducción técnica	182
04.1	Standard ball bearings / Rodamientos de bolas estándar	188
04.2	Special ball bearings / Rodamientos de bolas especiales	208

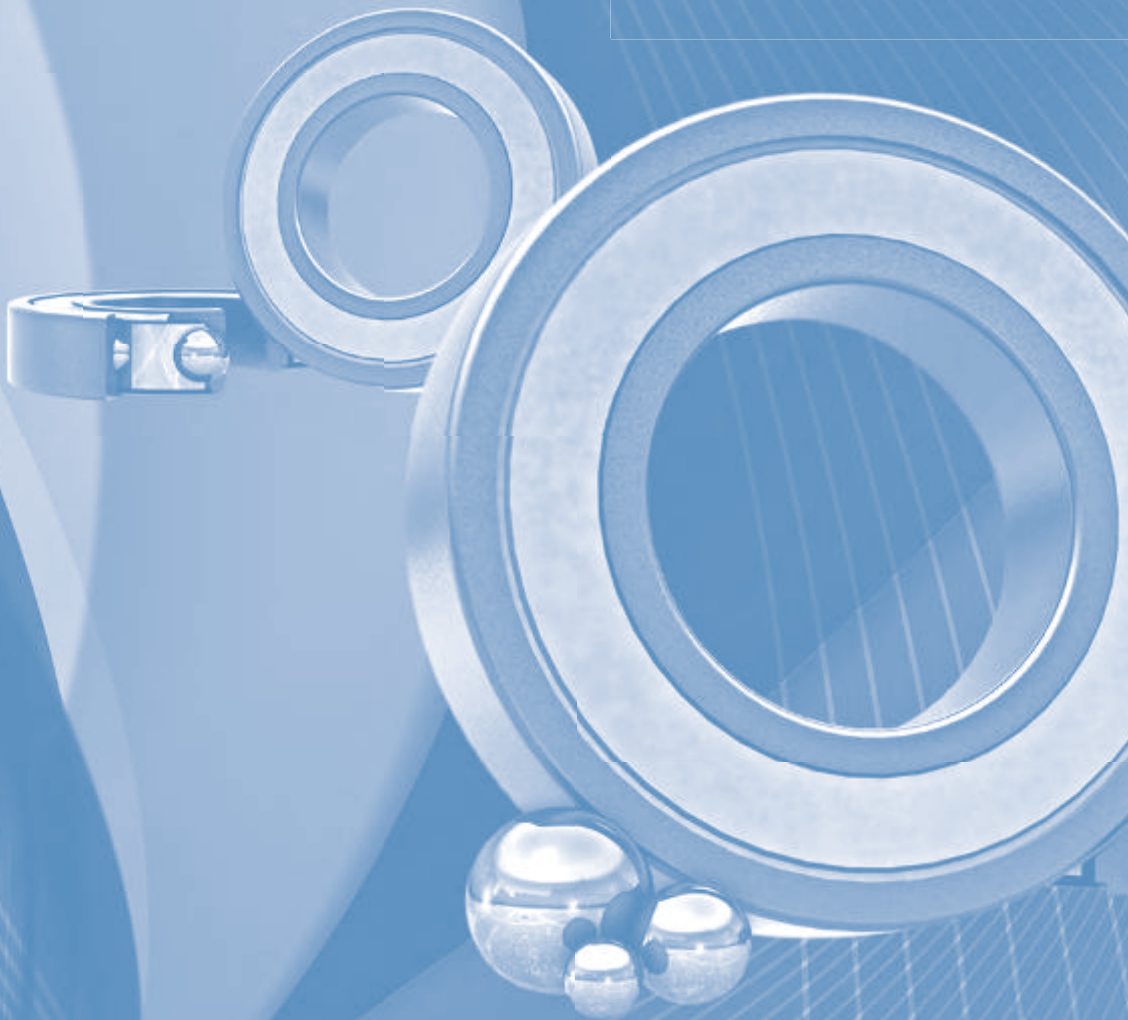

Product overview / Introducción

Description

Deep groove ball bearings are the most popular type of bearings and consequently, they are used for most of the applications. Deep groove ball bearings are non-separable.

Deep groove ball bearings can accommodate radial and thrust loads. Although they never reach the level of other types of bearings such as cylindrical roller bearings, tapered roller bearings or others, deep groove ball bearings are superior in speed rating to any other type of rolling element bearing.

Technical dimensions are in accordance with the ISO 15 norm and with the dimensions of the snap ring grooves detailed in the ISO 464 norm.

Sealed and Shielded Bearings

In addition to open deep groove ball bearings, Fersa supplies deep groove ball bearings with shields or seals on both sides (2RS or ZZ). They are supplied grease filled by the factory with approved high quality bearing grease, suitable for a temperature range of between -20°C to 110°C (-4°F to 230°F). The approximate amount of grease is from 20% to 50 % of the free space in the bearing.

Design

Ball bearings are machine components consisting of an outer ring, inner ring, balls, retainers, shields and snap rings. Due to their low friction torque, deep groove ball bearings are suitable for high speeds.

Fersa also manufactures bearings with snap grooves and snap rings in the outer ring (N, NR) meant to facilitate the axial assembly in some cases. Snap rings fitted to deep groove ball bearings with a snap ring groove provide a simple and space-saving means of axially locating the bearing in the housing

Descripción

El rodamiento de bolas de una hilera es el rodamiento más popular y es el que interviene en la mayor parte de las aplicaciones. Los rodamientos de bolas no son separables.

Los rodamientos radiales de bolas pueden soportar cargas radiales y axiales. Aunque sin llegar nunca a los niveles de rodamientos como por ejemplo cilíndrico o cónico. La velocidad de giro de los rodamientos de bolas es superior a otros tipos de rodamientos.

Las dimensiones técnicas cumplen con la Normativa ISO 15 y con las dimensiones de ranura para anillo elástico detalladas en la Normativa ISO 464.

Rodamientos Protegidos y Sellados

Además de los rodamientos de bolas de una hilera sin protección, FERSA Bearings también suministra rodamientos de bolas de una hilera con placas de protección (ZZ) o con tapas de retén (2RS) en los dos extremos. Estos rodamientos se suministran lubricados de fábrica con la grasa de alta calidad autorizada para rodamientos y pueden utilizarse a temperaturas comprendidas entre -20°C to 110°C (-4°F a 230°F). Por regla general la cantidad de grasa oscila entre un 20% a un 50% del espacio libre en el rodamiento.

Diseño

Los rodamientos de bolas son componentes de maquinaria que tienen elementos como: aro exterior, aro interior, bolas, retenes, placas de protección, etc.

Fersa también fabrica rodamientos con ranura y anillos elásticos en el aro exterior (N, NR), para facilitar en algunos casos el montaje axial. Los anillos elásticos ajustados a los rodamientos de una hilera con ranura son un método sencillo, además de una forma de ahorrar espacio, para ubicar el rodamiento en su alojamiento correspondiente.

Bearing features / Características del rodamiento

Tolerances

Single row groove bearings are manufactured according to normal tolerances (ISO 492 and ISO 5753) and with normal radial internal clearance as standard.

Tolerancias

Los rodamientos de bolas de una hilera se fabrican según las tolerancias normales (ISO 492 y ISO 5753), y con el juego radial interno normal.

Normal tolerances for radial bearings / Tolerancias normales para rodamientos radiales

Bore diameter / Diámetro interno

d		Δ_{dmp}		V_{dp}			V_{dmp}	K_{ia}
over	incl	high	low	series 7,8,9	series 0,1	series 2,3,4	max	max
mm		μm		μm			μm	μm
-	2,5	0	-8	10	8	6	6	10
2,5	10	0	-8	10	8	6	6	10
10	18	0	-8	10	8	6	6	10
18	30	0	-10	13	10	8	8	13
30	50	0	-12	15	12	9	9	15
50	80	0	-15	19	19	11	11	20
80	120	0	-20	25	25	15	15	25
120	180	0	-25	31	31	19	19	30

Outer diameter / Diámetro externo

D		Δ_{Dmp}		V_{Dp}			V_{Dmp}	K_{ea}
over	incl	high	low	series 7,8,9	series 0,1	series 2,3,4	max	max
mm		μm		μm			μm	μm
6	18	0	-8	10	8	6	6	15
18	30	0	-9	12	9	7	7	15
30	50	0	-11	14	11	8	8	20
50	80	0	-13	16	13	10	10	25
80	120	0	-15	19	19	11	11	35
120	150	0	-18	23	23	14	14	40
150	180	0	-25	31	31	19	19	45
180	250	0	-30	38	38	23	23	50

Bearing width / Anchura de rodamiento

d		Δ_{Bs}		V_{Bs}
over	incl	high	low	max
mm		μm		μm
-	2,5	0	-120	10
2,5	10	0	-120	10
10	18	0	-120	10
18	30	0	-120	13
30	50	0	-120	15
50	80	0	-150	19
80	120	0	-200	25
120	180	0	-250	31

Misalignment

Deep groove ball bearings allow only small misalignment between the inner and the outer rings, which requires a tight tolerance in the manufacturing of the housing. Under normal application conditions misalignment is usually between 2 and 10 minutes. It should be noted that when the bearing is running, misalignment of the bearing rings will cause a noticeable increase of the noise level.

Internal Clearance

Regarding the internal clearance, Fersa can supply deep groove ball bearings with normal radial clearance, as well as C3 and C4 radial clearance (as per ISO 5753 norm).

Desalineación

Los rodamientos radiales de bolas de una hilera admiten solo una pequeña desalineación entre los aros interior y exterior, y por lo tanto requieren una buena tolerancia en la mecanización de los alojamientos. En condiciones de aplicación normales la desalineación suele ser entre 2 a 10 minutos de ángulo. Debe tenerse en cuenta que la desalineación de los aros de los rodamientos causa un incremento considerable del nivel del ruido cuando el rodamiento está funcionando.

Juego interno

En lo referente al juego radial interno, Fersa puede suministrar rodamientos de bolas de una hilera con juego radial normal, además de con juego radial C3 y C4 (según la Normativa ISO 5753).

Radial internal clearance / Juego radial interno

Bore diameter / Diámetro interior

d		C2		Normal		C3		C4	
over	incl	mín	max	mín	max	mín	max	mín	max
mm		µm		µm		µm		µm	
-	6	0	7	2	13	28	13	-	-
6	10	0	7	2	13	8	23	14	29
10	18	0	9	3	18	11	25	18	33
18	24	0	10	5	20	13	28	20	36
24	30	1	11	5	20	13	28	23	41
30	40	1	11	6	20	15	33	28	46
40	50	1	11	6	23	18	36	30	51
50	65	1	15	8	28	23	43	38	61
65	80	1	15	10	30	25	51	46	71
80	100	1	18	12	36	30	58	53	84
100	120	2	20	15	41	36	66	61	97
120	140	2	23	18	48	41	81	71	114
140	160	2	23	18	53	46	91	81	130
160	180	2	25	20	61	53	102	91	147
180	200	2	30	25	71	63	117	107	163
200	225	2	35	25	85	75	140	125	195
225	250	2	40	30	95	85	160	145	225

Speed

Depending on the lubrication agent, oil or grease, different speed ratings can be defined. When a bearing operates under a load, heat is generated internally as a result of rolling, sliding and fluid friction. As the bearing speed increases, the temperature of the bearing also increases. If the bearing temperature exceeds certain limits, the efficiency of the lubricant falls drastically and the bearing will no longer operate in a stable manner.

Therefore, the maximum speed at which the bearing can continuously operate without generating heat beyond a specified limit is called the speed limit or allowable speed. Under this value and at the manufacturers specified load condition, the generated heat will be dissipated as fast as it is created.

The actual allowable speed of a bearing depends primarily on: bearing type and size; lubricant type and quantity; bearing load; bearing cage; bearing precision; and ambient temperature.

Velocidad

Según el lubricante que se utilice, aceite o grasa, se pueden definir diferentes ratios de velocidad. Cuando un rodamiento funciona con una carga se genera calor interno como resultado del movimiento, deslizamiento y fricción del fluido. A medida que incrementa la velocidad del rodamiento, también incrementa el calor de éste. Si la temperatura del rodamiento sobrepasa ciertos límites, la eficiencia del lubricante decae radicalmente y el rodamiento no operará de una forma estable.

Por lo tanto la velocidad máxima para que un rodamiento funcione ininterrumpidamente sin generar calor más allá de un límite determinado, se llama el límite de velocidad o velocidad permitida. Por debajo de este valor y con la carga especificada por el fabricante, el calor generado se disipará tan rápido como se genera. La velocidad real permitida a un rodamiento depende principalmente de: tipo de rodamiento y tamaño; tipo de lubricante y cantidad; carga del rodamiento; jaula del rodamiento; precisión del rodamiento; temperatura ambiente.

Cages

Basic deep groove ball bearings are normally fitted with pressed steel cages as standard.

Other materials as copper alloy and polyamide can be supplied on demand.

Equivalent Dynamic Bearing Load

In the case of deep groove ball bearings, the axial load capacity and the X and Y factors are required for the calculation of the actual dynamic equivalent bearing load. The load capacity is calculated according to ISO 76 and ISO 281.

$$P = X Fr + Y Fa \text{ when } Fa/Fr > e$$

$$P = Fr \text{ when } Fa/Fr \leq e$$

The X and Y factors depend on the relationship of the axial load to the basic static load rating C_0 . They are also influenced by the radial internal clearance, where higher clearance enables heavier axial loads to be carried.

Equivalent Static Bearing Load

$$P_0 = 0,6 * Fr + 0,5 * Fa.$$

$$\text{If } P_0 < Fr, P_0 = Fr$$

When P_0 is smaller than Fr , the higher value must be used for the calculation of the equivalent static bearing load.

Jaulas

En general, los rodamientos de bolas de una hilera estándar se montan con jaulas de acero prensado. Pero se puede solicitar y suministrar otros materiales como el latón y la poliamida.

Carga Dinámica Equivalente del Rodamiento

En el caso de los rodamientos radiales de bolas de una hilera, para poder hacer el cálculo real de la carga dinámica equivalente del rodamiento se requiere la capacidad axial de carga y los factores X e Y. La capacidad de carga se calcula según la Normativa ISO 76 y la Normativa ISO 281.

$$P = X Fr + Y Fa \text{ cuando } Fa/Fr > e$$

$$P = Fr \text{ cuando } Fa/Fr \leq e$$

Los factores X e Y dependen de la relación de la carga axial con respecto al ratio C_0 de carga estática básica. Estos también se ven influenciados por el juego radial interno, donde un juego mayor permite soportar una carga axial más pesada.

Carga Estática Equivalente del Rodamiento

$$P_0 = 0,6 * Fr + 0,5 * Fa.$$

$$\text{Si } P_0 < Fr, P_0 = Fr$$

Cuando P_0 es menor que Fr , se debe usar el valor más alto para calcular el equivalente de la carga estática del rodamiento.

Calculation factors X and Y for deep groove ball bearings /

Calculo de los factores X e Y para los Rodamientos de bolas de una hilera juego axial

Normal clearance / Holgura normal						C3 clearance / Holgura C3						C4 clearance / Holgura C4					
Fa/Co	e	F _a /F _r <e		F _a /F _r >e		e	F _a /F _r <e		F _a /F _r >e		e	F _a /F _r <e		F _a /F _r >e			
		X	Y	X	Y		X	Y	X	Y		X	Y				
0,025	0,22	1	0	0,56	2	0,31	1	0	0,46	1,75	0,4	1	0	0,44	1,042		
0,04	0,24	1	0	0,56	1,8	0,33	1	1	0,46	1,62	0,42	1	0	0,44	1,36		
0,07	0,27	1	1	0,56	1,6	0,36	1	1	0,46	1,46	0,44	1	0	0,44	1,27		
0,13	0,31	1	0	0,56	1,4	0,41	1	0	0,46	1,3	0,48	1	0	0,44	1,16		
0,25	0,37	1	0	0,56	1,2	0,46	1	0	0,46	1,14	0,53	1	0	0,44	1,05		
0,5	0,44	1	0	0,56	1	0,54	1	0	0,46	1	0,56	1	0	0,44	1		

04.1

STANDARD BALL BEARINGS RODAMIENTOS DE BOLAS ESTÁNDAR

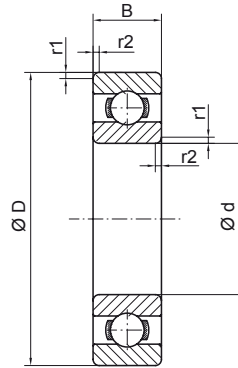

DIMENSIONS / DIMENSIONES							REFERENCES / REFERENCIAS
d		D		B		r1/r2 min	
mm	inch	mm	inch	mm	inch	mm	
6,000	0,236	19,000	0,748	6,000	0,236	0,3	626
		19,000	0,748	6,000	0,236	0,3	626 2RS
		19,000	0,748	6,000	0,236	0,3	626 ZZ
7,000	0,276	19,000	0,748	6,000	0,236	0,3	607
		19,000	0,748	6,000	0,236	0,3	607 2RS
		19,000	0,748	6,000	0,236	0,3	607 ZZ
8,000	0,315	22,000	0,866	7,000	0,276	0,3	608
		22,000	0,866	7,000	0,276	0,3	608 2RS
		22,000	0,866	7,000	0,276	0,3	608 ZZ
		24,000	0,945	8,000	0,315	0,3	628
		24,000	0,945	8,000	0,315	0,3	628 2RS
		24,000	0,945	8,000	0,315	0,3	628 ZZ
9,000	0,354	24,000	0,945	7,000	0,276	0,3	609
		24,000	0,945	7,000	0,276	0,3	609 2RS
		24,000	0,945	7,000	0,276	0,3	609 ZZ
		26,000	1,024	8,000	0,315	0,3	629
		26,000	1,024	8,000	0,315	0,3	629 2RS
		26,000	1,024	8,000	0,315	0,3	629 ZZ
10,000	0,394	26,000	1,024	8,000	0,315	0,5	6000
		26,000	1,024	8,000	0,315	0,5	6000 2RS
		26,000	1,024	8,000	0,315	0,5	6000 ZZ
		30,000	1,181	9,000	0,354	1,0	6200
		30,000	1,181	9,000	0,354	1,0	6200 2RS
		30,000	1,181	9,000	0,354	1,0	6200 ZZ
		35,000	1,378	11,000	0,433	1,0	6300
		35,000	1,378	11,000	0,433	1,0	6300 2RS
		35,000	1,378	11,000	0,433	1,0	6300 ZZ
12,000	0,472	28,000	1,102	8,000	0,315	0,5	6001
		28,000	1,102	8,000	0,315	0,5	6001 2RS

Assembly / Montaje

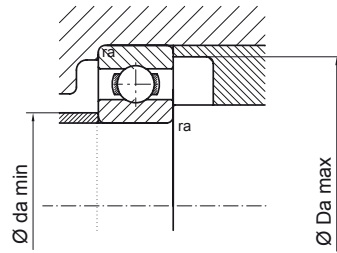

Suffixes / Sufijos

- Z** Shield at one side / Tapa en una cara
- ZZ** Shields at both sides / Tapas en las dos caras
- RS** Rubbing seal at one side / Tapa retén en una cara
- 2RS** Rubbing seals at both sides / Tapa retén en las dos caras

WEIGHT / PESO		ASSEMBLY / MONTAJE			LOAD / CARGA			SPEED / VELOCIDAD		REFERENCES / REFERENCIAS
					Dynamic / Dinámica	Static / Estática		Oil / Aceite	Grease / Grasa	
kg	lb	da min	Da max	ra max	C	Co	fo	na	ng	
		mm	mm	mm	kN	kN	kN	rpm	rpm	
0,009	0,020	16,6	8,4	0,3	2,6	1,1	13,0	38000	---	626
0,009	0,020	16,6	8,4	0,3	2,6	1,1	13,0	---	31700	626 2RS
0,009	0,020	16,6	8,4	0,3	2,6	1,1	13,0	---	31700	626 ZZ
0,008	0,018	16,6	9,4	0,3	2,6	1,1	13,1	40000	---	607
0,008	0,018	16,6	9,4	0,3	2,6	1,1	13,1	---	33300	607 2RS
0,008	0,018	16,6	9,4	0,3	2,6	1,1	13,1	---	33300	607 ZZ
0,010	0,022	10,0	20,0	0,3	3,5	1,4	12,4	42000	---	608
0,010	0,022	10,0	20,0	0,3	3,5	1,4	12,4	---	21000	608 2RS
0,010	0,022	10,0	20,0	0,3	3,5	1,4	12,4	---	35000	608 ZZ
0,017	0,037	21,6	10,4	0,3	4,0	1,6	11,9	29700	---	628
0,017	0,037	21,6	10,4	0,3	4,0	1,6	11,9	---	24700	628 2RS
0,017	0,037	21,6	10,4	0,3	4,0	1,6	11,9	---	24700	628 ZZ
0,014	0,031	21,6	11,4	0,3	3,9	1,7	13,1	31500	---	609
0,014	0,031	21,6	11,4	0,3	3,9	1,7	13,1	---	26300	609 2RS
0,014	0,031	21,6	11,4	0,3	3,9	1,7	13,1	---	26300	609 ZZ
0,020	0,044	23,6	11,4	0,3	4,8	2,0	12,4	27100	---	629 2RS
0,020	0,044	23,6	11,4	0,3	4,8	2,0	12,4	---	22600	629 2RS
0,020	0,044	23,6	11,4	0,3	4,8	2,0	12,4	---	22600	629 ZZ
0,019	0,042	12,0	24,0	0,5	4,7	1,9	12,4	36000	---	6000
0,019	0,042	12,0	24,0	0,5	4,7	1,9	12,4	---	18000	6000 2RS
0,019	0,042	12,0	24,0	0,5	4,7	1,9	12,4	---	30000	6000 ZZ
0,031	0,068	14,0	26,0	1,0	5,4	2,4	12,1	30000	---	6200
0,031	0,068	14,0	26,0	1,0	5,4	2,4	12,1	---	15000	6200 2RS
0,031	0,068	14,0	26,0	1,0	5,4	2,4	12,1	---	25000	6200 ZZ
0,053	0,117	14,0	31,0	1,0	7,9	3,4	11,3	27000	---	6300
0,053	0,117	14,0	31,0	1,0	7,9	3,4	11,3	---	13000	6300 2RS
0,053	0,117	14,0	31,0	1,0	7,9	3,4	11,3	---	22000	6300 ZZ
0,022	0,048	14,0	26,0	0,5	5,2	2,3	13,0	33000	---	6001
0,022	0,048	14,0	26,0	0,5	5,2	2,3	13,0	---	16000	6001 2RS



04.1

STANDARD BALL BEARINGS RODAMIENTOS DE BOLAS ESTÁNDAR

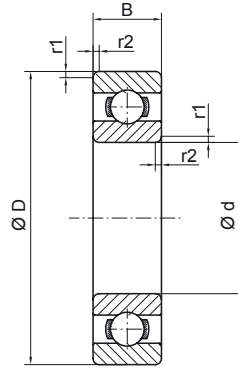

DIMENSIONS / DIMENSIONES							REFERENCES / REFERENCIAS
d		D		B		r1/r2 min	
mm	inch	mm	inch	mm	inch	mm	
12,000	0,472	28,000	1,102	8,000	0,315	0,5	6001 ZZ
		32,000	1,260	10,000	0,394	1,0	6201
		32,000	1,260	10,000	0,394	1,0	6201 2RS
		32,000	1,260	10,000	0,394	1,0	6201 ZZ
		32,000	1,260	14,000	0,551	0,6	62201
		32,000	1,260	14,000	0,551	0,6	62201 2RS
		32,000	1,260	14,000	0,551	0,6	62201 ZZ
		37,000	1,457	12,000	0,472	1,5	6301
		37,000	1,457	12,000	0,472	1,5	6301 2RS
		37,000	1,457	12,000	0,472	1,5	6301 ZZ
		40,000	1,575	12,000	0,472	0,6	6203/12 2RS
15,000	0,591	32,000	1,260	9,000	0,354	0,5	6002
		32,000	1,260	9,000	0,354	0,5	6002 2RS
		32,000	1,260	9,000	0,354	0,5	6002 ZZ
		35,000	1,378	11,000	0,433	1,0	6202
		35,000	1,378	11,000	0,433	1,0	6202 2RS
		35,000	1,378	11,000	0,433	1,0	6202 ZZ
		35,000	1,378	14,000	0,551	0,6	62202
		35,000	1,378	14,000	0,551	0,6	62202 2RS
		35,000	1,378	14,000	0,551	0,6	62202 ZZ
		42,000	1,654	13,000	0,512	1,5	6302
		42,000	1,654	13,000	0,512	1,5	6302 2RS
		42,000	1,654	13,000	0,512	1,5	6302 ZZ
		47,000	1,850	14,000	0,551	1,5	6303/15 2RS
17,000	0,669	35,000	1,378	10,000	0,394	0,5	6003
		35,000	1,378	10,000	0,394	0,5	6003 2RS
		35,000	1,378	10,000	0,394	0,5	6003 ZZ
		40,000	1,575	12,000	0,472	1,0	6203
		40,000	1,575	12,000	0,472	1,0	6203 2RS

Assembly / Montaje

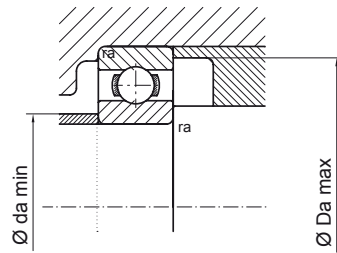

Suffixes / Sufijos

- Z** Shield at one side / Tapa en una cara
- ZZ** Shields at both sides / Tapas en las dos caras
- RS** Rubbing seal at one side / Tapa retén en una cara
- 2RS** Rubbing seals at both sides / Tapa retén en las dos caras

WEIGHT / PESO		ASSEMBLY / MONTAJE			LOAD / CARGA			SPEED / VELOCIDAD		REFERENCES / REFERENCIAS
					Dynamic / Dinámica	Static / Estática	fo	Oil / Aceite	Grease/Grasa	
kg	lb	da min	Da max	ra max	C	Co		na	ng	
		mm	mm	mm	kN	kN	kN	rpm	rpm	
0,022	0,048	14,0	26,0	0,5	5,2	2,3	13,0	---	27000	6001 ZZ
0,036	0,079	16,0	28,0	1,0	7,1	3,1	12,3	27000	---	6201
0,036	0,079	16,0	28,0	1,0	7,1	3,1	12,3	---	14000	6201 2RS
0,036	0,079	16,0	28,0	1,0	7,1	3,1	12,3	---	23000	6201 ZZ
0,052	0,114	16,0	28,0	0,6	7,2	3,0	12,2	27000	---	62201
0,052	0,114	16,0	28,0	0,6	7,2	3,0	12,2	---	14000	62201 2RS
0,052	0,114	16,0	28,0	0,6	7,2	3,0	12,2	---	23000	62201 ZZ
0,060	0,132	17,5	31,5	1,5	9,8	4,2	11,1	25000	---	6301
0,060	0,132	17,5	31,5	1,5	9,8	4,2	11,1	---	12000	6301 2RS
0,060	0,132	17,5	31,5	1,5	9,8	4,2	11,1	---	20000	6301 ZZ
0,075	0,165	16,0	36,0	0,6	10,0	4,8	13,1	---	12000	6203/12 2RS
0,029	0,064	17,0	30,0	0,5	5,9	2,8	13,9	28000	---	6002
0,029	0,064	17,0	30,0	0,5	5,9	2,8	13,9	---	14000	6002 2RS
0,029	0,064	17,0	30,0	0,5	5,9	2,8	13,9	---	23000	6002 ZZ
0,044	0,097	19,0	31,0	1,0	8,0	3,7	13,1	24000	---	6202
0,044	0,097	19,0	31,0	1,0	8,0	3,7	13,1	---	12000	6202 2RS
0,044	0,097	19,0	31,0	1,0	8,0	3,7	13,1	---	20000	6202 ZZ
0,057	0,125	19,0	31,0	0,6	8,1	3,8	12,1	24000	---	62202
0,057	0,125	19,0	31,0	0,6	8,1	3,8	12,1	---	12000	62202 2RS
0,057	0,125	19,0	31,0	0,6	8,1	3,8	12,1	---	20000	62202 ZZ
0,083	0,183	20,5	36,5	1,5	11,9	5,3	12,1	21000	---	6302
0,083	0,183	20,5	36,5	1,5	11,9	5,3	12,1	---	11000	6302 2RS
0,083	0,183	20,5	36,5	1,5	11,9	5,3	12,1	---	18000	6302 ZZ
0,120	0,264	20,5	41,5	1,5	14,2	6,5	12,3	---	10000	6303/15 2RS
0,038	0,084	19,0	33,0	0,5	6,0	3,3	14,3	25000	---	6003
0,038	0,084	19,0	33,0	0,5	6,0	3,3	14,3	---	13000	6003 2RS
0,038	0,084	19,0	33,0	0,5	6,0	3,3	14,3	---	21000	6003 ZZ
0,064	0,141	21,0	36,0	1,0	10,0	4,8	13,1	21000	---	6203
0,064	0,141	21,0	36,0	1,0	10,0	4,8	13,1	---	11000	6203 2RS



04.1

STANDARD BALL BEARINGS RODAMIENTOS DE BOLAS ESTÁNDAR

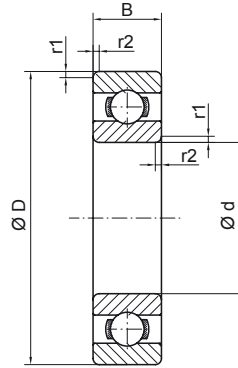

DIMENSIONS / DIMENSIONES							REFERENCES / REFERENCIAS
d		D		B		r1/r2 min	
mm	inch	mm	inch	mm	inch	mm	
17,000	0,669	40,000	1,575	12,000	0,472	1,0	6203 ZZ
		47,000	1,850	14,000	0,551	1,5	6303
		47,000	1,850	14,000	0,551	1,5	6303 2RS
		47,000	1,850	14,000	0,551	1,5	6303 ZZ
		52,000	2,047	15,000	0,591	1,1	6304/17 2RS
		52,000	2,047	16,000	0,630	1,1	6304/17 B16 2RS
		52,000	2,047	17,000	0,669	1,0	6304/17 B17 2RS
		62,000	2,441	17,000	0,669	2,0	6403
		62,000	2,441	17,000	0,669	2,0	6403 2RS
		62,000	2,441	17,000	0,669	2,0	6403 ZZ
20,000	0,787	37,000	1,457	9,000	0,354	0,5	61904
		37,000	1,457	9,000	0,354	0,5	61904 2RS
		37,000	1,457	9,000	0,354	0,5	61904 ZZ
		42,000	1,654	12,000	0,472	1,0	6004
		42,000	1,654	12,000	0,472	1,0	6004 2RS
		42,000	1,654	12,000	0,472	1,0	6004 ZZ
		47,000	1,850	14,000	0,551	1,5	6204
		47,000	1,850	14,000	0,551	1,5	6204 2RS
		47,000	1,850	14,000	0,551	1,5	6204 ZZ
		47,000	1,850	18,000	0,709	1,0	62204
		47,000	1,850	18,000	0,709	1,0	62204 2RS
		47,000	1,850	18,000	0,709	1,0	62204 ZZ
		52,000	2,047	12,000	0,472	1,1	6304 B12
		52,000	2,047	15,000	0,591	2,0	6304
		52,000	2,047	15,000	0,591	2,0	6304 2RS
		52,000	2,047	15,000	0,591	2,0	6304 ZZ
		52,000	2,047	21,000	0,827	1,1	62304
		52,000	2,047	21,000	0,827	1,1	62304 2RS
		52,000	2,047	21,000	0,827	1,1	62304 ZZ

Assembly / Montaje

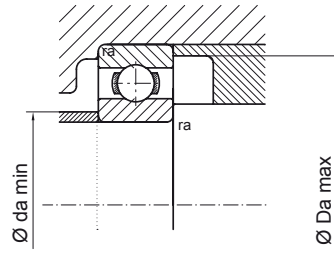

Suffixes / Sufijos

- Z** Shield at one side / Tapa en una cara
- ZZ** Shields at both sides / Tapas en las dos caras
- RS** Rubbing seal at one side / Tapa retén en una cara
- 2RS** Rubbing seals at both sides / Tapa retén en las dos caras

WEIGHT / PESO		ASSEMBLY / MONTAJE			LOAD / CARGA			SPEED / VELOCIDAD		REFERENCES / REFERENCIAS
					Dynamic / Dinámica	Static / Estática	fo	Oil / Aceite	Grease/Grasa	
kg	lb	da min	Da max	ra max	C	Co		na	ng	
		mm	mm	mm	kN	kN	kN	rpm	rpm	
0,064	0,141	21,0	36,0	1,0	10,0	4,8	13,1	---	18000	6203 ZZ
0,115	0,253	22,5	41,5	1,5	14,2	6,5	12,3	19000	---	6303
0,115	0,253	22,5	41,5	1,5	14,2	6,5	12,3	---	9000	6303 2RS
0,115	0,253	22,5	41,5	1,5	14,2	6,5	12,3	---	16000	6303 ZZ
0,150	0,330	24,0	45,0	1,1	16,7	7,9	12,4	---	9000	6304/17 2RS
0,160	0,352	24,0	45,0	1,1	16,7	7,9	13,2	---	9000	6304/17 B16 2RS
0,170	0,374	24,0	45,0	1,0	16,7	7,9	12,2	---	9000	6304/17 B17 2RS
0,270	0,594	23,5	55,5	2,0	23,9	10,8	12,4	15000	---	6403
0,270	0,594	23,5	55,5	2,0	23,9	10,8	12,4	---	8000	6403 2RS
0,270	0,594	23,5	55,5	2,0	23,9	10,8	12,4	---	13000	6403 ZZ
0,038	0,084	22,0	35,0	0,5	6,4	3,7	14,8	23000	---	61904
0,038	0,084	22,0	35,0	0,5	6,4	3,7	14,8	---	11000	61904 2RS
0,038	0,084	22,0	35,0	0,5	6,4	3,7	14,8	---	19000	61904 ZZ
0,067	0,147	23,0	39,0	1,0	9,8	5,0	13,9	21000	---	6004
0,067	0,147	23,0	39,0	1,0	9,8	5,0	13,9	---	11000	6004 2RS
0,067	0,147	23,0	39,0	1,0	9,8	5,0	13,9	---	18000	6004 ZZ
0,110	0,242	25,5	41,5	1,5	13,4	6,6	13,1	18000	---	6204
0,110	0,242	25,5	41,5	1,5	13,4	6,6	13,1	---	9000	6204 2RS
0,110	0,242	25,5	41,5	1,5	13,4	6,6	13,1	---	15000	6204 ZZ
0,140	0,308	25,5	41,5	1,0	13,3	7,7	13,1	18000	---	62204
0,140	0,308	25,5	41,5	1,0	13,3	7,7	13,1	---	9000	62204 2RS
0,140	0,308	25,5	41,5	1,0	13,3	7,7	13,1	---	15000	62204 ZZ
0,120	0,264	27,0	45,0	1,1	14,7	7,7	12,4	17000	---	6304 B12
0,140	0,308	27,0	45,0	2,0	16,7	7,9	12,4	17000	---	6304
0,140	0,308	27,0	45,0	2,0	16,7	7,9	12,4	---	8000	6304 2RS
0,140	0,308	27,0	45,0	2,0	16,7	7,9	12,4	---	14000	6304 ZZ
0,200	0,440	45,0	27,0	1,0	16,7	7,8	12,4	16700	13900	62304 2RS
0,200	0,440	45,0	27,0	1,0	16,7	7,8	12,4	16700	13900	62304 2RS
0,200	0,440	45,0	27,0	1,0	16,7	7,8	12,4	16700	13900	62304 2RS



04.1

STANDARD BALL BEARINGS RODAMIENTOS DE BOLAS ESTÁNDAR

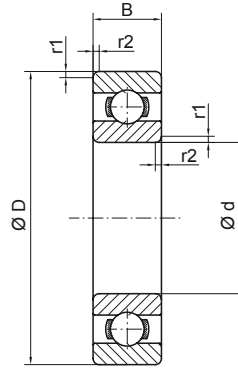

DIMENSIONS / DIMENSIONES							REFERENCES / REFERENCIAS
d		D		B		r1/r2 min	
mm	inch	mm	inch	mm	inch	mm	
20,000	0,787	56,000	2,205	12,000	0,472	1,1	6304 B12 D56
		56,000	2,205	12,000	0,472	1,1	6304 B12 D56
		56,000	2,205	12,000	0,472	1,1	6304 B12 D56
		72,000	2,835	19,000	0,748	2,0	6404
		72,000	2,835	19,000	0,748	2,0	6404 2RS
		72,000	2,835	19,000	0,748	2,0	6404 ZZ
22,000	0,866	50,000	1,969	14,000	0,551	1,0	62/22
		56,000	2,205	16,000	0,630	2,0	63/22
25,000	0,984	47,000	1,850	12,000	0,472	1,0	6005
		47,000	1,850	12,000	0,472	1,0	6005 2RS
		47,000	1,850	12,000	0,472	1,0	6005 ZZ
		52,000	2,047	15,000	0,591	1,5	6205
		52,000	2,047	15,000	0,591	1,5	6205 2RS
		52,000	2,047	15,000	0,591	1,5	6205 ZZ
		56,000	2,205	12,000	0,472	1,1	6205 B12 D56
		62,000	2,441	17,000	0,669	2,0	6305
		62,000	2,441	17,000	0,669	2,0	6305 2RS
		62,000	2,441	17,000	0,669	2,0	6305 ZZ
		62,000	2,441	24,000	0,945	1,1	62305
		62,000	2,441	24,000	0,945	1,1	62305 2RS
		62,000	2,441	24,000	0,945	1,1	62305 ZZ
		72,000	2,835	19,000	0,748	1,1	6306/25
		80,000	3,150	21,000	0,827	2,5	6405
80,000	3,150	21,000	0,827	2,5	6405 2RS		
80,000	3,150	21,000	0,827	2,5	6405 ZZ		
28,000	1,102	68,000	2,677	18,000	0,709	2,0	63/28
28,575	1,125	71,438	2,813	20,638	0,813	2,3	RMS 9
30,000	1,181	55,000	2,165	13,000	0,512	1,5	6006
		55,000	2,165	13,000	0,512	1,5	6006 2RS

Assembly / Montaje

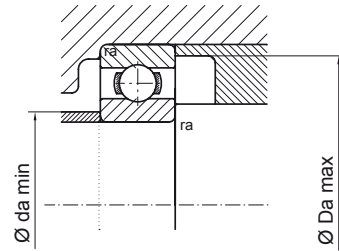

Suffixes / Sufijos

- Z** Shield at one side / Tapa en una cara
- ZZ** Shields at both sides / Tapas en las dos caras
- RS** Rubbing seal at one side / Tapa retén en una cara
- 2RS** Rubbing seals at both sides / Tapa retén en las dos caras

WEIGHT / PESO		ASSEMBLY / MONTAJE			LOAD / CARGA			SPEED / VELOCIDAD		REFERENCES / REFERENCIAS
					Dynamic / Dinámica	Static / Estática	fo	Oil / Aceite	Grease/Grasa	
kg	lb	da min	Da max	ra max	C	Co	fo	na	ng	
		mm	mm	mm	kN	kN	kN	rpm	rpm	
0,165	0,363	27,0	49,0	1,1	10,5	5,9	14,8	16000	---	6304 B12
0,165	0,363	27,0	49,0	1,1	10,5	5,9	14,8	16000	---	6304 B12 D56
0,165	0,363	27,0	49,0	1,1	10,5	5,9	14,8	16000	---	6304 B12 D56
0,410	0,902	29,0	63,0	2,0	32,1	15,0	13,0	13000	---	6404
0,410	0,902	29,0	63,0	2,0	32,1	15,0	13,0	---	6000	6404 2RS
0,410	0,902	29,0	63,0	2,0	32,1	15,0	13,0	---	11000	6404 ZZ
0,110	0,242	27,5	44,5	1,0	14,5	7,5	14,0	---	8000	62/22 2RS
0,175	0,385	45,0	33,0	2,0	19,4	9,3	12,1	15400	12800	63/22 C3
0,078	0,172	28,0	44,0	1,0	10,6	5,8	14,5	18000	---	6005
0,078	0,172	28,0	44,0	1,0	10,6	5,8	14,5	---	9000	6005 2RS
0,078	0,172	28,0	44,0	1,0	10,6	5,8	14,5	---	15000	6005 ZZ
0,130	0,286	30,5	46,5	1,5	14,7	7,8	13,8	16000	---	6205
0,130	0,286	30,5	46,5	1,5	14,7	7,8	13,8	---	8000	6205 2RS
0,130	0,286	30,5	46,5	1,5	14,7	7,8	13,8	---	13000	6205 ZZ
0,115	0,253	30,5	51,5	1,1	14,7	7,8	14,1	16000	---	6205 B12 D56
0,230	0,506	32,0	55,0	2,0	23,5	11,5	12,4	14000	---	6305
0,230	0,506	32,0	55,0	2,0	23,5	11,5	12,4	---	7000	6305 2RS
0,230	0,506	32,0	55,0	2,0	23,5	11,5	12,4	---	12000	6305 ZZ
0,320	0,704	32,0	55,0	1,1	23,5	11,5	12,5	14000	---	62305
0,320	0,704	32,0	55,0	1,1	23,5	11,5	12,5	---	7000	62305 2RS
0,320	0,704	32,0	55,0	1,1	23,5	11,5	12,5	---	12000	62305 ZZ
0,380	0,836	65,0	32,0	1,0	28,3	15,1	13,0	12400	10300	6306/25 2RS
0,540	1,188	34,0	71,0	2,5	39,1	18,7	13,1	11000	---	6405
0,540	1,188	34,0	71,0	2,5	39,1	18,7	13,1	---	6000	6405 2RS
0,540	1,188	34,0	71,0	2,5	39,1	18,7	13,1	---	9000	6405 ZZ
0,280	0,616	57,0	39,0	2,0	23,9	12,0	13,0	12500	10400	63/28 C3
0,370	0,814	38,0	62,0	2,3	28,1	16,0	13,0	---	6000	RMS 9
0,118	0,260	34,5	50,5	1,5	13,9	8,3	14,8	15000	---	6006
0,118	0,260	34,5	50,5	1,5	13,9	8,3	14,8	---	8000	6006 2RS



04.1

STANDARD BALL BEARINGS RODAMIENTOS DE BOLAS ESTÁNDAR

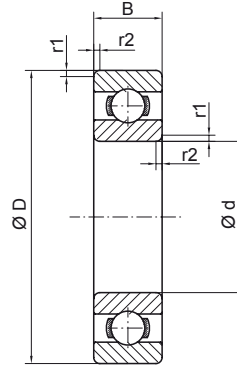

DIMENSIONS / DIMENSIONES							REFERENCES / REFERENCIAS
d		D		B		r1/r2 min	
mm	inch	mm	inch	mm	inch	mm	
30,000	1,181	55,000	2,165	13,000	0,512	1,5	6006 ZZ
		62,000	2,441	16,000	0,630	1,5	6206
		62,000	2,441	16,000	0,630	1,5	6206 2RS
		62,000	2,441	16,000	0,630	1,5	6206 ZZ
		62,000	2,441	20,000	0,787	1,0	62206
		62,000	2,441	20,000	0,787	1,0	62206 2RS
		62,000	2,441	20,000	0,787	1,0	62206 ZZ
		72,000	2,835	19,000	0,748	2,0	6306
		72,000	2,835	19,000	0,748	2,0	6306 2RS
		72,000	2,835	19,000	0,748	2,0	6306 ZZ
		72,000	2,835	27,000	1,063	1,1	62306
		72,000	2,835	27,000	1,063	1,1	62306 2RS
		72,000	2,835	27,000	1,063	1,1	62306 ZZ
		90,000	3,543	23,000	0,906	2,5	6406
		90,000	3,543	23,000	0,906	2,5	6406 2RS
90,000	3,543	23,000	0,906	2,5	6406 ZZ		
32,000	1,260	55,000	2,165	13,000	0,512	0,6	6006/32
		75,000	2,953	20,000	0,787	1,5	63/32
33,000	1,299	72,000	2,835	17,000	0,669	2,0	6207/33
35,000	1,378	62,000	2,441	14,000	0,551	1,5	6007
		62,000	2,441	14,000	0,551	1,5	6007 2RS
		62,000	2,441	14,000	0,551	1,5	6007 ZZ
		72,000	2,835	17,000	0,669	2,0	6207
		72,000	2,835	17,000	0,669	2,0	6207 2RS
		72,000	2,835	17,000	0,669	2,0	6207 ZZ
		72,000	2,835	23,000	0,906	1,1	62207
		72,000	2,835	23,000	0,906	1,1	62207 2RS
		72,000	2,835	23,000	0,906	1,1	62207 ZZ
		80,000	3,150	21,000	0,827	2,0	6307

Assembly / Montaje

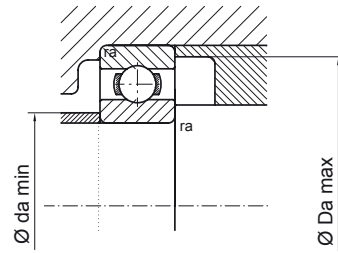

Suffixes / Sufijos

- Z** Shield at one side / Tapa en una cara
- ZZ** Shields at both sides / Tapas en las dos caras
- RS** Rubbing seal at one side / Tapa retén en una cara
- 2RS** Rubbing seals at both sides / Tapa retén en las dos caras

WEIGHT / PESO		ASSEMBLY / MONTAJE			LOAD / CARGA			SPEED / VELOCIDAD		REFERENCES / REFERENCIAS
					Dynamic / Dinámica	Static / Estática	fo	Oil / Aceite	Grease/Grasa	
kg	lb	da min	Da max	ra max	C	Co		na	ng	
		mm	mm	mm	kN	kN	kN	rpm	rpm	
0,118	0,260	34,5	50,5	1,5	13,9	8,3	14,8	---	13000	6006 ZZ
0,200	0,440	35,5	56,5	1,5	20,4	11,3	13,8	13000	---	6206
0,200	0,440	35,5	56,5	1,5	20,4	11,3	13,8	---	7000	6206 2RS
0,200	0,440	35,5	56,5	1,5	20,4	11,3	13,8	---	11000	6206 ZZ
0,240	0,528	35,5	56,5	1,0	20,4	11,0	13,8	13000	---	62206
0,240	0,528	35,5	56,5	1,0	20,4	11,0	13,8	---	7000	62206 2RS
0,240	0,528	35,5	56,5	1,0	20,4	11,0	13,8	---	11000	62206 ZZ
0,350	0,770	37,0	65,0	2,0	28,3	15,1	13,0	12000	---	6306
0,350	0,770	37,0	65,0	2,0	28,3	15,1	13,0	---	6000	6306 2RS
0,350	0,770	37,0	65,0	2,0	28,3	15,1	13,0	---	10000	6306 ZZ
0,500	1,100	37,0	65,0	1,1	29,5	15,9	13,0	12000	---	62306
0,500	1,100	37,0	65,0	1,1	29,5	15,9	13,0	---	6000	62306 2RS
0,500	1,100	37,0	65,0	1,1	29,5	15,9	13,0	---	10000	62306 ZZ
0,740	1,628	41,0	79,0	2,5	49,7	24,4	12,2	10000	---	6406
0,740	1,628	41,0	79,0	2,5	49,7	24,4	12,2	---	5000	6406 2RS
0,740	1,628	41,0	79,0	2,5	49,7	24,4	12,2	---	8000	6406 ZZ
0,111	0,244	50,4	36,6	1,0	13,9	8,3	14,8	14900	12500	6006/32
0,400	0,880	70,2	36,8	1,5	31,3	16,9	13,1	11200	9300	63/32 NR C3
0,350	0,770	40,0	65,0	2,0	26,9	15,3	13,8	11000	---	6207/33
0,155	0,341	39,5	57,5	1,5	16,8	10,3	14,8	13000	---	6007
0,155	0,341	39,5	57,5	1,5	16,8	10,3	14,8	---	7000	6007 2RS
0,155	0,341	39,5	57,5	1,5	16,8	10,3	14,8	---	11000	6007 ZZ
0,290	0,638	42,0	65,0	2,0	26,9	15,3	13,8	11000	---	6207
0,290	0,638	42,0	65,0	2,0	26,9	15,3	13,8	---	6000	6207 2RS
0,290	0,638	42,0	65,0	2,0	26,9	15,3	13,8	---	9000	6207 ZZ
0,385	0,847	42,0	65,0	1,1	26,9	15,0	13,8	11000	---	62207
0,385	0,847	42,0	65,0	1,1	26,9	15,0	13,8	---	6000	62207 2RS
0,385	0,847	42,0	65,0	1,1	26,9	15,0	13,8	---	9000	62207 ZZ
0,460	1,012	44,0	71,0	2,0	35,4	18,7	13,1	10000	---	6307



04.1

STANDARD BALL BEARINGS RODAMIENTOS DE BOLAS ESTÁNDAR

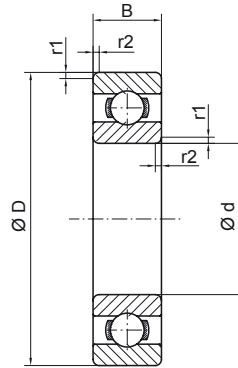

DIMENSIONS / DIMENSIONES							REFERENCES / REFERENCIAS
d		D		B		r1/r2 min	
mm	inch	mm	inch	mm	inch	mm	
35,000	1,378	80,000	3,150	21,000	0,827	2,0	6307 2RS
		80,000	3,150	21,000	0,827	2,0	6307 ZZ
		80,000	3,150	23,000	0,906	1,5	6307 B23
		100,000	3,937	25,000	0,984	2,5	6407
		100,000	3,937	25,000	0,984	2,5	6407 2RS
		100,000	3,937	25,000	0,984	2,5	6407 ZZ
40,000	1,575	68,000	2,677	15,000	0,591	1,5	6008
		68,000	2,677	15,000	0,591	1,5	6008 2RS
		68,000	2,677	15,000	0,591	1,5	6008 ZZ
		80,000	3,150	18,000	0,709	2,0	6208
		80,000	3,150	18,000	0,709	2,0	6208 2RS
		80,000	3,150	18,000	0,709	2,0	6208 ZZ
		80,000	3,150	23,000	0,906	1,1	62208
		80,000	3,150	23,000	0,906	1,1	62208 2RS
		80,000	3,150	23,000	0,906	1,1	62208 ZZ
		90,000	3,543	23,000	0,906	2,5	6308
		90,000	3,543	23,000	0,906	2,5	6308 2RS
		90,000	3,543	23,000	0,906	2,5	6308 ZZ
		110,000	4,331	27,000	1,063	3,0	6408
		110,000	4,331	27,000	1,063	3,0	6408 2RS
110,000	4,331	27,000	1,063	3,0	6408 ZZ		
40,000 / 41,500	1,575 / 1,6338	80,000	3,150	18,000	0,709	0,8	6208 K 2RS
45,000	1,772	68,000	2,677	12,000	0,472	0,8	61909
		68,000	2,677	12,000	0,472	0,8	61909 2RS
		68,000	2,677	12,000	0,472	0,8	61909 ZZ
		75,000	2,953	16,000	0,630	1,5	6009
		75,000	2,953	16,000	0,630	1,5	6009 2RS
		75,000	2,953	16,000	0,630	1,5	6009 ZZ
		85,000	3,346	19,000	0,748	2,0	6209

Assembly / Montaje

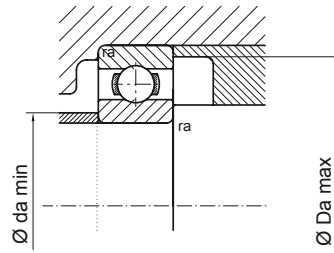

Suffixes / Sufijos

- Z** Shield at one side / Tapa en una cara
- ZZ** Shields at both sides / Tapas en las dos caras
- RS** Rubbing seal at one side / Tapa retén en una cara
- 2RS** Rubbing seals at both sides / Tapa retén en las dos caras

WEIGHT / PESO		ASSEMBLY / MONTAJE			LOAD / CARGA			SPEED / VELOCIDAD		REFERENCES / REFERENCIAS
					Dynamic / Dinámica	Static / Estática	fo	Oil / Aceite	Grease/Grasa	
kg	lb	da min	Da max	ra max	C	Co		na	ng	
		mm	mm	mm	kN	kN	kN	rpm	rpm	
0,460	1,012	44,0	71,0	2,0	35,4	18,7	13,1	---	5000	6307 2RS
0,460	1,012	44,0	71,0	2,0	35,4	18,7	13,1	---	9000	6307 ZZ
0,500	1,100	44,0	71,0	1,5	34,9	19,1	13,1	10000	---	6307 B23
0,960	2,112	46,0	89,0	2,5	58,3	29,4	12,1	9000	---	6407
0,960	2,112	46,0	89,0	2,5	58,3	29,4	12,1	---	4000	6407 2RS
0,960	2,112	46,0	89,0	2,5	58,3	29,4	12,1	---	7000	6407 ZZ
0,190	0,418	44,5	63,5	1,5	17,7	11,6	15,3	12000	---	6008
0,190	0,418	44,5	63,5	1,5	17,7	11,6	15,3	---	6000	6008 2RS
0,190	0,418	44,5	63,5	1,5	17,7	11,6	15,3	---	10000	6008 ZZ
0,370	0,814	47,0	73,0	2,0	31,0	18,1	14,0	10000	---	6208
0,370	0,814	47,0	73,0	2,0	31,0	18,1	14,0	---	5000	6208 2RS
0,370	0,814	47,0	73,0	2,0	31,0	18,1	14,0	---	8000	6208 ZZ
0,470	1,034	47,0	73,0	1,1	30,6	17,5	14,0	10000	---	62208
0,470	1,034	47,0	73,0	1,1	30,6	17,5	14,0	---	5000	62208 2RS
0,470	1,034	47,0	73,0	1,1	30,6	17,5	14,0	---	8000	62208 ZZ
0,630	1,386	49,0	81,0	2,5	42,7	24,0	13,0	9000	---	6308
0,630	1,386	49,0	81,0	2,5	42,7	24,0	13,0	---	5000	6308 2RS
0,630	1,386	49,0	81,0	2,5	42,7	24,0	13,0	---	8000	6308 ZZ
1,255	2,761	53,0	97,0	3,0	66,6	36,5	12,2	8000	---	6408
1,255	2,761	53,0	97,0	3,0	66,6	36,5	12,2	---	4000	6408 2RS
1,255	2,761	53,0	97,0	3,0	66,6	36,5	12,2	---	7000	6408 ZZ
0,365	0,803	73,0	47,0	1,0	29,5	18,1	14,3	10000	8300	6208 K 2RS
0,140	0,308	48,0	65,0	0,8	14,3	9,9	15,7	12000	---	61909
0,140	0,308	48,0	65,0	0,8	14,3	9,9	15,7	---	6000	61909 2RS
0,140	0,308	48,0	65,0	0,8	14,3	9,9	15,7	---	10000	61909 ZZ
0,240	0,528	51,0	69,0	1,5	22,1	14,8	15,4	11000	---	6009
0,240	0,528	51,0	69,0	1,5	22,1	14,8	15,4	---	5000	6009 2RS
0,240	0,528	51,0	69,0	1,5	22,1	14,8	15,4	---	9000	6009 ZZ
0,410	0,902	52,0	78,0	2,0	33,2	20,6	14,3	9000	---	6209



04.1

STANDARD BALL BEARINGS RODAMIENTOS DE BOLAS ESTÁNDAR

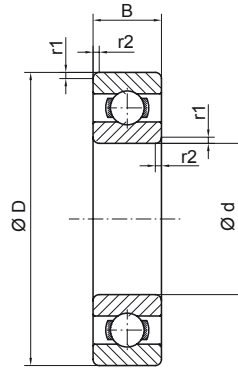

DIMENSIONS / DIMENSIONES							REFERENCES / REFERENCIAS
d		D		B		r1/r2 min	
mm	inch	mm	inch	mm	inch	mm	
45,000	1,772	85,000	3,346	19,000	0,748	2,0	6209 2RS
		85,000	3,346	19,000	0,748	2,0	6209 ZZ
		100,000	3,937	25,000	0,984	2,5	6309
		100,000	3,937	25,000	0,984	2,5	6309 2RS
		100,000	3,937	25,000	0,984	2,5	6309 ZZ
		120,000	4,724	29,000	1,142	3,0	6409
		120,000	4,724	29,000	1,142	3,0	6409 2RS
		120,000	4,724	29,000	1,142	3,0	6409 ZZ
50,000	1,969	80,000	3,150	16,000	0,630	1,5	6010
		80,000	3,150	16,000	0,630	1,5	6010 2RS
		80,000	3,150	16,000	0,630	1,5	6010 ZZ
		80,000	3,150	23,000	0,906	1,0	63010
		80,000	3,150	23,000	0,906	1,0	63010 2RS
		80,000	3,150	23,000	0,906	1,0	63010 ZZ
		90,000	3,543	20,000	0,787	2,0	6210
		90,000	3,543	20,000	0,787	2,0	6210 2RS
		90,000	3,543	20,000	0,787	2,0	6210 ZZ
		110,000	4,331	27,000	1,063	3,0	6310
		110,000	4,331	27,000	1,063	3,0	6310 2RS
		110,000	4,331	27,000	1,063	3,0	6310 ZZ
		130,000	5,118	31,000	1,220	3,5	6410
130,000	5,118	31,000	1,220	3,5	6410 2RS		
130,000	5,118	31,000	1,220	3,5	6410 ZZ		
55,000	2,165	90,000	3,543	18,000	0,709	2,0	6011
		90,000	3,543	18,000	0,709	2,0	6011 2RS
		90,000	3,543	18,000	0,709	2,0	6011 ZZ
		100,000	3,937	21,000	0,827	2,5	6211
		100,000	3,937	21,000	0,827	2,5	6211 2RS
		100,000	3,937	21,000	0,827	2,5	6211 ZZ

Assembly / Montaje

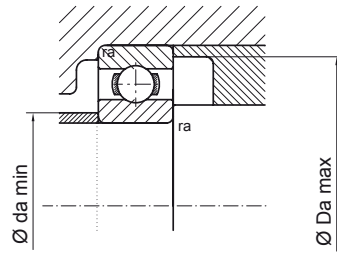

Suffixes / Sufijos

- Z** Shield at one side / Tapa en una cara
- ZZ** Shields at both sides / Tapas en las dos caras
- RS** Rubbing seal at one side / Tapa retén en una cara
- 2RS** Rubbing seals at both sides / Tapa retén en las dos caras

WEIGHT / PESO		ASSEMBLY / MONTAJE			LOAD / CARGA			SPEED / VELOCIDAD		REFERENCES / REFERENCIAS
					Dynamic / Dinámica	Static / Estática	fo	Oil / Aceite	Grease/Grasa	
kg	lb	da min	Da max	ra max	C	Co	fo	na	ng	
		mm	mm	mm	kN	kN	kN	rpm	rpm	
0,410	0,902	52,0	78,0	2,0	33,2	20,6	14,3	---	5000	6209 2RS
0,410	0,902	52,0	78,0	2,0	33,2	20,6	14,3	---	8000	6209 ZZ
0,840	1,848	54,0	91,0	2,5	50,7	27,7	13,0	8000	---	6309
0,840	1,848	54,0	91,0	2,5	50,7	27,7	13,0	---	4000	6309 2RS
0,840	1,848	54,0	91,0	2,5	50,7	27,7	13,0	---	7000	6309 ZZ
1,560	3,432	58,0	107,0	3,0	80,2	45,0	12,1	7000	---	6409
1,560	3,432	58,0	107,0	3,0	80,2	45,0	12,1	---	4000	6409 2RS
1,560	3,432	58,0	107,0	3,0	80,2	45,0	12,1	---	6000	6409 ZZ
0,260	0,572	54,5	75,5	1,5	23,1	16,2	15,6	10000	---	6010
0,260	0,572	54,5	75,5	1,5	23,1	16,2	15,6	---	5000	6010 2RS
0,260	0,572	54,5	75,5	1,5	23,1	16,2	15,6	---	8000	6010 ZZ
0,370	0,814	57,0	73,0	1,0	21,5	16,0	15,4	9000	---	63010
0,370	0,814	57,0	73,0	1,0	21,5	16,0	15,4	---	5000	63010 2RS
0,370	0,814	57,0	73,0	1,0	21,5	16,0	15,4	---	8000	63010 ZZ
0,460	1,012	57,0	83,0	2,0	36,8	23,2	14,3	9000	---	6210
0,460	1,012	57,0	83,0	2,0	36,8	23,2	14,3	---	4000	6210 2RS
0,460	1,012	57,0	83,0	2,0	36,8	23,2	14,3	---	7000	6210 ZZ
1,075	2,365	59,0	101,0	3,0	65,0	37,7	13,0	8000	---	6310
1,075	2,365	59,0	101,0	3,0	65,0	37,7	13,0	---	4000	6310 2RS
1,075	2,365	59,0	101,0	3,0	65,0	37,7	13,0	---	6000	6310 ZZ
1,925	4,235	64,0	116,0	3,5	96,2	54,2	13,1	7000	---	6410
1,925	4,235	64,0	116,0	3,5	96,2	54,2	13,1	---	3000	6410 2RS
1,925	4,235	64,0	116,0	3,5	96,2	54,2	13,1	---	6000	6410 ZZ
0,390	0,858	61,0	84,0	2,0	31,8	21,9	15,4	9000	---	6011
0,390	0,858	61,0	84,0	2,0	31,8	21,9	15,4	---	5000	6011 2RS
0,390	0,858	61,0	84,0	2,0	31,8	21,9	15,4	---	8000	6011 ZZ
0,610	1,342	64,0	91,0	2,5	45,5	29,2	14,3	8000	---	6211
0,610	1,342	64,0	91,0	2,5	45,5	29,2	14,3	---	4000	6211 2RS
0,610	1,342	64,0	91,0	2,5	45,5	29,2	14,3	---	7000	6211 ZZ



04.1

STANDARD BALL BEARINGS RODAMIENTOS DE BOLAS ESTÁNDAR

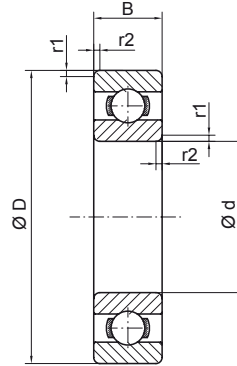

DIMENSIONS / DIMENSIONES							REFERENCES / REFERENCIAS
d		D		B		r1/r2 min	
mm	inch	mm	inch	mm	inch	mm	
55,000	2,165	120,000	4,724	29,000	1,142	3,0	6311
		120,000	4,724	29,000	1,142	3,0	6311 2RS
		120,000	4,724	29,000	1,142	3,0	6311 ZZ
		140,000	5,512	33,000	1,299	3,5	6411
		140,000	5,512	33,000	1,299	3,5	6411 2RS
		140,000	5,512	33,000	1,299	3,5	6411 ZZ
60,000	2,362	95,000	3,740	18,000	0,709	2,0	6012
		95,000	3,740	18,000	0,709	2,0	6012 2RS
		95,000	3,740	18,000	0,709	2,0	6012 ZZ
		110,000	4,331	22,000	0,866	2,5	6212
		110,000	4,331	22,000	0,866	2,5	6212 2RS
		110,000	4,331	22,000	0,866	2,5	6212 ZZ
		130,000	5,118	31,000	1,220	3,5	6312
		130,000	5,118	31,000	1,220	3,5	6312 2RS
		130,000	5,118	31,000	1,220	3,5	6312 ZZ
		150,000	5,906	35,000	1,378	3,5	6412
		150,000	5,906	35,000	1,378	3,5	6412 2RS
		150,000	5,906	35,000	1,378	3,5	6412 ZZ
65,000	2,559	100,000	3,937	18,000	0,709	2,0	6013
		100,000	3,937	18,000	0,709	2,0	6013 2RS
		100,000	3,937	18,000	0,709	2,0	6013 ZZ
		120,000	4,724	23,000	0,906	2,5	6213
		120,000	4,724	23,000	0,906	2,5	6213 2RS
		120,000	4,724	23,000	0,906	2,5	6213 ZZ
		140,000	5,512	33,000	1,299	3,5	6313
		140,000	5,512	33,000	1,299	3,5	6313 2RS
		140,000	5,512	33,000	1,299	3,5	6313 ZZ
		160,000	6,299	37,000	1,457	3,5	6413
		160,000	6,299	37,000	1,457	3,5	6413 2RS

Assembly / Montaje

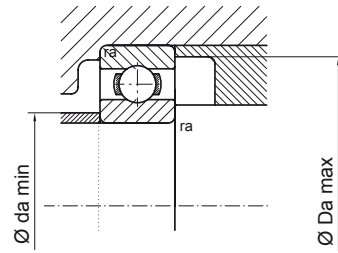

Suffixes / Sufijos

- Z** Shield at one side / Tapa en una cara
- ZZ** Shields at both sides / Tapas en las dos caras
- RS** Rubbing seal at one side / Tapa retén en una cara
- 2RS** Rubbing seals at both sides / Tapa retén en las dos caras

WEIGHT / PESO		ASSEMBLY / MONTAJE			LOAD / CARGA			SPEED / VELOCIDAD		REFERENCES / REFERENCIAS
					Dynamic / Dinámica	Static / Estática	fo	Oil / Aceite	Grease/Grasa	
kg	lb	da min	Da max	ra max	C	Co		na	ng	
		mm	mm	mm	kN	kN	kN	rpm	rpm	
1,370	3,014	66,0	109,0	3,0	75,0	44,6	12,9	7000	---	6311
1,370	3,014	66,0	109,0	3,0	75,0	44,6	12,9	---	3000	6311 2RS
1,370	3,014	66,0	109,0	3,0	75,0	44,6	12,9	---	6000	6311 ZZ
2,330	5,126	69,0	126,0	3,5	104,8	62,0	13,2	6000	---	6411
2,330	5,126	69,0	126,0	3,5	104,8	62,0	13,2	---	3000	6411 2RS
2,330	5,126	69,0	126,0	3,5	104,8	62,0	13,2	---	5000	6411 ZZ
0,420	0,924	66,0	89,0	2,0	33,0	24,4	15,5	8000	---	6012
0,420	0,924	66,0	89,0	2,0	33,0	24,4	15,5	---	4000	6012 2RS
0,420	0,924	66,0	89,0	2,0	33,0	24,4	15,5	---	7000	6012 ZZ
0,780	1,716	69,0	101,0	2,5	50,2	33,0	14,3	7000	---	6212
0,780	1,716	69,0	101,0	2,5	50,2	33,0	14,3	---	4000	6212 2RS
0,780	1,716	69,0	101,0	2,5	50,2	33,0	14,3	---	6000	6212 ZZ
1,710	3,762	72,0	118,0	3,5	85,9	51,8	13,1	6000	---	6312
1,710	3,762	72,0	118,0	3,5	85,9	51,8	13,1	---	3000	6312 2RS
1,710	3,762	72,0	118,0	3,5	85,9	51,8	13,1	---	5000	6312 ZZ
2,770	6,094	74,0	136,0	3,5	115,5	69,5	13,2	6000	---	6412
2,770	6,094	74,0	136,0	3,5	115,5	69,5	13,2	---	3000	6412 2RS
2,770	6,094	74,0	136,0	3,5	115,5	69,5	13,2	---	5000	6412 ZZ
0,440	0,968	71,0	94,0	2,0	33,3	24,2	15,7	8000	---	6013
0,440	0,968	71,0	94,0	2,0	33,3	24,2	15,7	---	4000	6013 2RS
0,440	0,968	71,0	94,0	2,0	33,3	24,2	15,7	---	7000	6013 ZZ
0,990	2,178	74,0	111,0	2,5	60,1	40,0	14,3	7000	---	6213
0,990	2,178	74,0	111,0	2,5	60,1	40,0	14,3	---	3000	6213 2RS
0,990	2,178	74,0	111,0	2,5	60,1	40,0	14,3	---	5000	6213 ZZ
2,115	4,653	77,0	128,0	3,5	97,2	59,9	13,2	6000	---	6313
2,115	4,653	77,0	128,0	3,5	97,2	59,9	13,2	---	3000	6313 2RS
2,115	4,653	77,0	128,0	3,5	97,2	59,9	13,2	---	5000	6313 ZZ
3,300	7,260	79,0	146,0	3,5	124,4	78,0	13,2	5000	---	6413
3,300	7,260	79,0	146,0	3,5	124,4	78,0	13,2	---	3000	6413 2RS



04.1

STANDARD BALL BEARINGS RODAMIENTOS DE BOLAS ESTÁNDAR

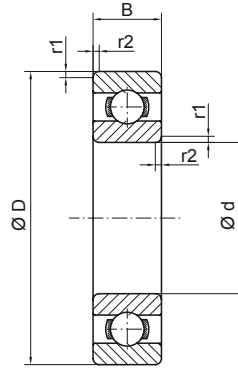

DIMENSIONS / DIMENSIONES							REFERENCES / REFERENCIAS
d		D		B		r1/r2 min	
mm	inch	mm	inch	mm	inch	mm	
65,000	2,559	160,000	6,299	37,000	1,457	3,5	6413 ZZ
70,000	2,756	110,000	4,331	20,000	0,787	2,0	6014
		110,000	4,331	20,000	0,787	2,0	6014 2RS
		110,000	4,331	20,000	0,787	2,0	6014 ZZ
		125,000	4,921	24,000	0,945	2,5	6214
		125,000	4,921	24,000	0,945	2,5	6214 2RS
		125,000	4,921	24,000	0,945	2,5	6214 ZZ
		150,000	5,906	35,000	1,378	3,5	6314
		150,000	5,906	35,000	1,378	3,5	6314 2RS
		150,000	5,906	35,000	1,378	3,5	6314 ZZ
		180,000	7,087	42,000	1,654	4,0	6414
		180,000	7,087	42,000	1,654	4,0	6414 2RS
		180,000	7,087	42,000	1,654	4,0	6414 ZZ
75,000	2,953	115,000	4,528	20,000	0,787	2,0	6015
		115,000	4,528	20,000	0,787	2,0	6015 2RS
		115,000	4,528	20,000	0,787	2,0	6015 ZZ
		130,000	5,118	25,000	0,984	2,5	6215
		130,000	5,118	25,000	0,984	2,5	6215 2RS
		130,000	5,118	25,000	0,984	2,5	6215 ZZ
		160,000	6,299	37,000	1,457	3,5	6315
		160,000	6,299	37,000	1,457	3,5	6315 2RS
		160,000	6,299	37,000	1,457	3,5	6315 ZZ
80,000	3,150	125,000	4,921	22,000	0,866	1,1	6016
		125,000	4,921	22,000	0,866	1,1	6016 2RS
		125,000	4,921	22,000	0,866	1,1	6016 ZZ
		140,000	5,512	26,000	1,024	3,0	6216
		140,000	5,512	26,000	1,024	3,0	6216 2RS
		140,000	5,512	26,000	1,024	3,0	6216 ZZ
85,000	3,346	150,000	5,906	28,000	1,102	2,0	6217

Assembly / Montaje

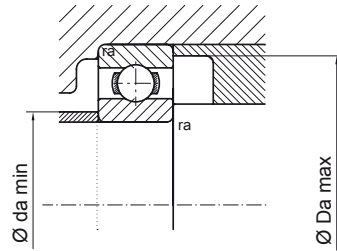

Suffixes / Sufijos

- Z** Shield at one side / Tapa en una cara
- ZZ** Shields at both sides / Tapas en las dos caras
- RS** Rubbing seal at one side / Tapa retén en una cara
- 2RS** Rubbing seals at both sides / Tapa retén en las dos caras

WEIGHT / PESO		ASSEMBLY / MONTAJE			LOAD / CARGA			SPEED / VELOCIDAD		REFERENCES / REFERENCIAS
					Dynamic / Dinámica	Static / Estática	fo	Oil / Aceite	Grease/Grasa	
kg	lb	da min	Da max	ra max	C	Co		na	ng	
		mm	mm	mm	kN	kN	kN	rpm	rpm	
3,300	7,260	79,0	146,0	3,5	124,4	78,0	13,2	---	4000	6413 ZZ
0,600	1,320	76,0	104,0	2,0	40,5	30,5	15,5	7000	---	6014
0,600	1,320	76,0	104,0	2,0	40,5	30,5	15,5	---	4000	6014 2RS
0,600	1,320	76,0	104,0	2,0	40,5	30,5	15,5	---	6000	6014 ZZ
1,060	2,332	79,0	116,0	2,5	63,9	44,9	14,3	6000	---	6214
1,060	2,332	79,0	116,0	2,5	63,9	44,9	14,3	---	3000	6214 2RS
1,060	2,332	79,0	116,0	2,5	63,9	44,9	14,3	---	5000	6214 ZZ
2,520	5,544	82,0	138,0	3,5	109,4	68,1	13,2	5000	---	6314
2,520	5,544	82,0	138,0	3,5	109,4	68,1	13,2	---	3000	6314 2RS
2,520	5,544	82,0	138,0	3,5	109,4	68,1	13,2	---	5000	6314 ZZ
4,830	10,626	86,0	164,0	4,0	150,2	104,0	13,3	5000	---	6414
4,830	10,626	86,0	164,0	4,0	150,2	104,0	13,3	---	2000	6414 2RS
4,830	10,626	86,0	164,0	4,0	150,2	104,0	13,3	---	4000	6414 ZZ
0,640	1,408	81,0	109,0	2,0	42,3	33,1	15,7	7000	---	6015
0,640	1,408	81,0	109,0	2,0	42,3	33,1	15,7	---	3000	6015 2RS
0,640	1,408	81,0	109,0	2,0	42,3	33,1	15,7	---	6000	6015 ZZ
1,200	2,640	84,0	121,0	2,5	69,5	49,3	14,7	6000	---	6215
1,200	2,640	84,0	121,0	2,5	69,5	49,3	14,7	---	3000	6215 2RS
1,200	2,640	84,0	121,0	2,5	69,5	49,3	14,7	---	5000	6215 ZZ
3,060	6,732	87,0	148,0	3,5	119,7	76,5	13,2	5000	---	6315
3,060	6,732	87,0	148,0	3,5	119,7	76,5	13,2	---	3000	6315 2RS
3,060	6,732	87,0	148,0	3,5	119,7	76,5	13,2	---	4000	6315 ZZ
0,880	1,936	86,0	119,0	1,1	50,0	39,8	15,6	6000	---	6016
0,880	1,936	86,0	119,0	1,1	50,0	39,8	15,6	---	3000	6016 2RS
0,880	1,936	86,0	119,0	1,1	50,0	39,8	15,6	---	5000	6016 ZZ
1,400	3,080	91,0	129,0	3,0	75,1	54,3	14,6	5000	---	6216
1,400	3,080	91,0	129,0	3,0	75,1	54,3	14,6	---	3000	6216 2RS
1,400	3,080	91,0	129,0	3,0	75,1	54,3	14,6	---	5000	6216 ZZ
1,800	3,960	94,0	141,0	2,0	87,5	63,7	14,7	5000	---	6217



04.1

STANDARD BALL BEARINGS RODAMIENTOS DE BOLAS ESTÁNDAR

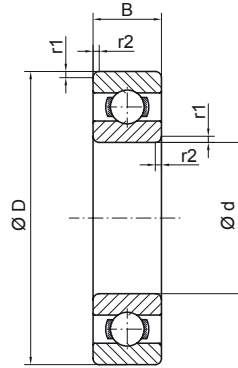

DIMENSIONS / DIMENSIONES							REFERENCES / REFERENCIAS
d		D		B		r1/r2 min	
mm	inch	mm	inch	mm	inch	mm	
85,000	3,346	150,000	5,906	28,000	1,102	2,0	6217 2RS
		150,000	5,906	28,000	1,102	2,0	6217 ZZ
90,000	3,543	160,000	6,299	30,000	1,181	2,0	6218
		160,000	6,299	30,000	1,181	2,0	6218 2RS
		160,000	6,299	30,000	1,181	2,0	6218 ZZ

Assembly / Montaje

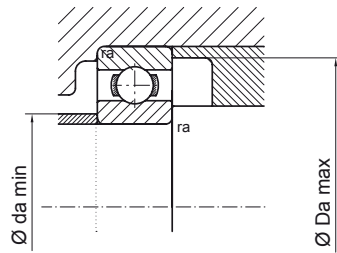

Suffixes / Sufijos

- Z** Shield at one side / Tapa en una cara
- ZZ** Shields at both sides / Tapas en las dos caras
- RS** Rubbing seal at one side / Tapa retén en una cara
- 2RS** Rubbing seals at both sides / Tapa retén en las dos caras

WEIGHT / PESO		ASSEMBLY / MONTAJE			LOAD / CARGA			SPEED / VELOCIDAD		REFERENCES / REFERENCIAS
		da min	Da max	ra max	Dynamic / Dinámica	Static / Estática	fo	Oil / Aceite	Grease/Grasa	
kg	lb	mm	mm	mm	C	Co	kN	na	ng	
					kN	kN	kN	rpm	rpm	
1,800	3,960	94,0	141,0	2,0	87,5	63,7	14,7	---	3000	6217 2RS
1,800	3,960	94,0	141,0	2,0	87,5	63,7	14,7	---	4000	6217 ZZ
2,150	4,730	101,0	149,0	2,0	100,8	71,6	14,5	5000	---	6218
2,150	4,730	101,0	149,0	2,0	100,8	71,6	14,5	---	2000	6218 2RS
2,150	4,730	101,0	149,0	2,0	100,8	71,6	14,5	---	4000	6218 ZZ

04.2

SPECIAL BALL BEARINGS RODAMIENTOS DE BOLAS ESPECIALES

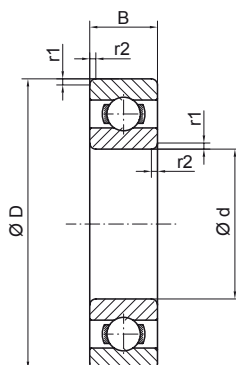
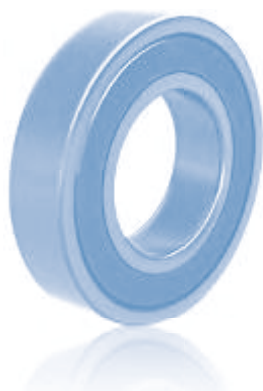

DIMENSIONS / DIMENSIONES									TYPE / TIPO	REFERENCES / REFERENCIAS
d		D		B		C		r1/r2 min		
mm	inch	mm	inch	mm	inch	mm	inch	mm		
12,000	0,472	32,000	1,260	15,350	0,604	10,000	0,394	0,6	E	F 18046 2RS
		32,000	1,260	15,350	0,604	10,000	0,394	0,6	E	F 18046 ZZ
15,000	0,591	35,000	1,378	13,000	0,512	13,000	0,512	0,6	A	F 18015
17,000	0,669	62,000	2,441	17,000	0,669	17,600	0,693	1,5	A	F 18020
25,000	0,984	59,000	2,323	17,500	0,689	17,500	0,689	0,6	B	F 18019
		62,020	2,442	17,500	0,689	17,500	0,689	0,6	B	F 18018
		69,000	2,717	20,000	0,787	20,000	0,787	0,8	A	F 18022
25,995	1,023	68,000	2,677	21,550	0,848	14,500	0,571	1,0	C	F 18024
28,000	1,102	66,000	2,598	18,000	0,709	18,000	0,709	0,6	B	F 18021
		75,000	2,953	21,000	0,827	21,000	0,827	0,5	D	F 18043
30,000	1,181	65,000	2,559	21,000	0,827	21,000	0,827	1,5	A	F 18011
		75,000	2,953	21,000	0,827	21,000	0,827	0,3	D	F 18047
32,000	1,260	80,000	3,150	23,000	0,906	23,000	0,906	0,3	D	F 18048
35,000	1,378	67,000	2,638	22,500	0,886	21,000	0,827	1,1	D	F 18025
		75,000	2,953	20,000	0,787	20,000	0,787	1,5	B	F 18023
36,487	1,436	68,000	2,677	15,000	0,591	15,000	0,591	1,0	A	F 18038
36,513	1,438	68,000	2,677	15,000	0,591	15,000	0,591	1,0	B	F 18039
45,000	1,772	85,000	3,346	23,000	0,906	23,000	0,906	1,5	E	F 18009
50,000	1,969	90,000	3,543	20,000	0,787	20,000	0,787	1,1	A	F 18032
		90,000	3,543	20,000	0,787	20,000	0,787	1,1	A	F 18033
		90,000	3,543	20,000	0,787	20,000	0,787	1,1	A	F 18041
55,000	2,165	120,000	4,724	29,000	1,142	29,000	1,142	1,0	A	F 18042
63,500	2,500	100,000	3,937	23,000	0,906	23,000	0,906	ESP	E	F 18040
85,000	3,346	150,000	5,906	28,000	1,102	28,000	1,102	2,0	A	F 18036
		160,000	6,299	33,000	1,299	33,000	1,299	2,0	A	F 18037

*E For more special drawing details, contact with Fersa / Para más información técnica, contactar con Fersa.

Type / Tipo

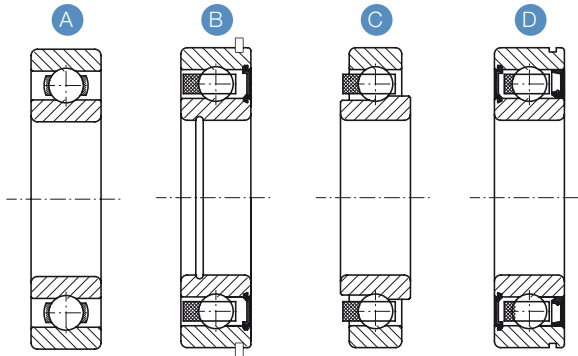

Assembly / Montaje

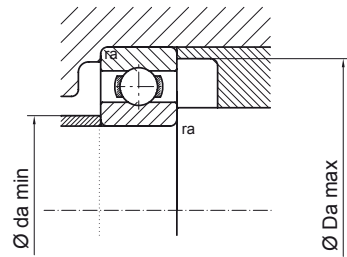

WEIGHT / PESO		ASSEMBLY / MONTAJE			LOAD / CARGA			SPEED / VELOCIDAD		REMARK / NOTA	REFERENCES / REFERENCIAS
					Dynamic / Dinámica	Static / Estática	fo	Oil / Aceite	Grease / Grasa		
kg	lb	da min	Da max	ra max	C	Co	fo	na	ng		
		mm	mm	mm	kN	kN	kN	rpm	rpm		
0,04	0,09	15,0	29,0	0,6	7,1	3,1	12,3	---	22700	Special Construction - Inner Ring Width = 10,000	F 18046 2RS
0,04	0,09	15,0	29,0	0,6	7,1	3,1	12,3	27300	---	Special Construction - Inner Ring Width = 10,000	F 18046 ZZ
0,50	1,10	19,0	31,0	0,6	8,1	3,8	13,0	---	13850	-	F 18015
0,28	0,61	23,5	55,5	1,5	23,0	11,9	12,0	---	7550	-	F 18020
0,19	0,42	29,0	53,5	0,6	25,0	12,3	12,0	---	6900	Snap in Outer Diameter	F 18019
0,22	0,47	32,0	55,0	0,6	27,6	13,5	11,8	---	6900	Snap in Outer Diameter	F 18018
0,35	0,77	35,0	63,5	0,8	31,2	15,7	12,0	---	6000	-	F 18022
0,29	0,63	ESP	62,5	1,0	31,4	15,8	12,0	13800	---	Outer Ring Width = 14,5 mm	F 18024
0,24	0,53	36,0	61,0	0,6	30,8	15,4	12,0	12000	---	Snap in Outer Diameter	F 18021
0,40	0,87	36,0	67,0	0,5	37,3	19,1	12,1	---	9700	Snap in Outer Diameter	F 18043
0,27	0,59	35,5	57,0	1,5	24,7	13,0	12,9	---	6500	-	F 18011
0,40	0,88	32,4	72,6	0,3	34,7	17,7	12,1	---	9500	Snap in Outer Diameter	F 18047
0,50	1,10	34,4	77,6	0,3	41,5	21,5	12,2	---	8900	Snap in Outer Diameter	F 18048
0,29	0,64	41,0	63,0	1,1	24,0	14,1	14,1	---	5600	Snap in Outer Diameter + Special Seal	F 18025
0,35	0,76	42,0	66,0	1,5	31,3	17,0	13,2	10400	---	Snap in Outer Diameter	F 18023
0,21	0,46	41,5	63,0	1,0	17,7	11,6	15,2	11200	---	-	F 18038
0,20	0,44	41,5	63,0	1,0	17,7	11,6	15,2	11200	---	Snap in Outer Diameter	F 18039
0,54	1,18	51,5	78,5	1,5	35,8	29,3	---	---	---	Double row ball bearing	F 18009
0,48	1,06	57,0	83,0	1,1	36,8	23,2	14,4	8600	---	Circlip in Outer Ring	F 18032
0,48	1,06	57,0	83,0	1,1	36,8	23,2	14,4	8600	---	Circlip in Outer Ring	F 18033
0,51	1,12	57,0	83,0	1,1	48,2	34,8	14,4	8600	---	Circlip in Outer Ring	F 18041
1,38	3,03	66,0	109,0	1,0	75,0	44,6	13,1	---	3450	-	F 18042
0,49	1,08	ESP	ESP	ESP	17,9	15,9	16,4	---	3550	Special Construction	F 18040
1,81	3,98	94,0	141,0	2,0	94,1	63,1	14,2	5100	---	Special Raceway + circlip in Outer Ring	F 18036
2,55	5,60	94,0	151,0	2,0	119,3	80,1	13,8	5100	---	Special Raceway + circlip in Outer Ring	F 18037



05

Angular contact ball bearings

Rodamientos de bolas de contacto angular

05.0	Technical introduction / Introducción técnica	212
05.1	Double row angular contact ball bearings / Rodamientos de bolas de doble hilera de contacto angular	218
05.2	Standard double row angular contact ball bearings / Rodamientos de bolas de doble hilera de contacto angular estándar	224
05.3	Four point angular contact ball bearings / Rodamientos de bolas de contacto angular de cuatro puntos	226
05.4	Air conditioning / Aire acondicionado	230

 **Fersa**[®]
Bearings

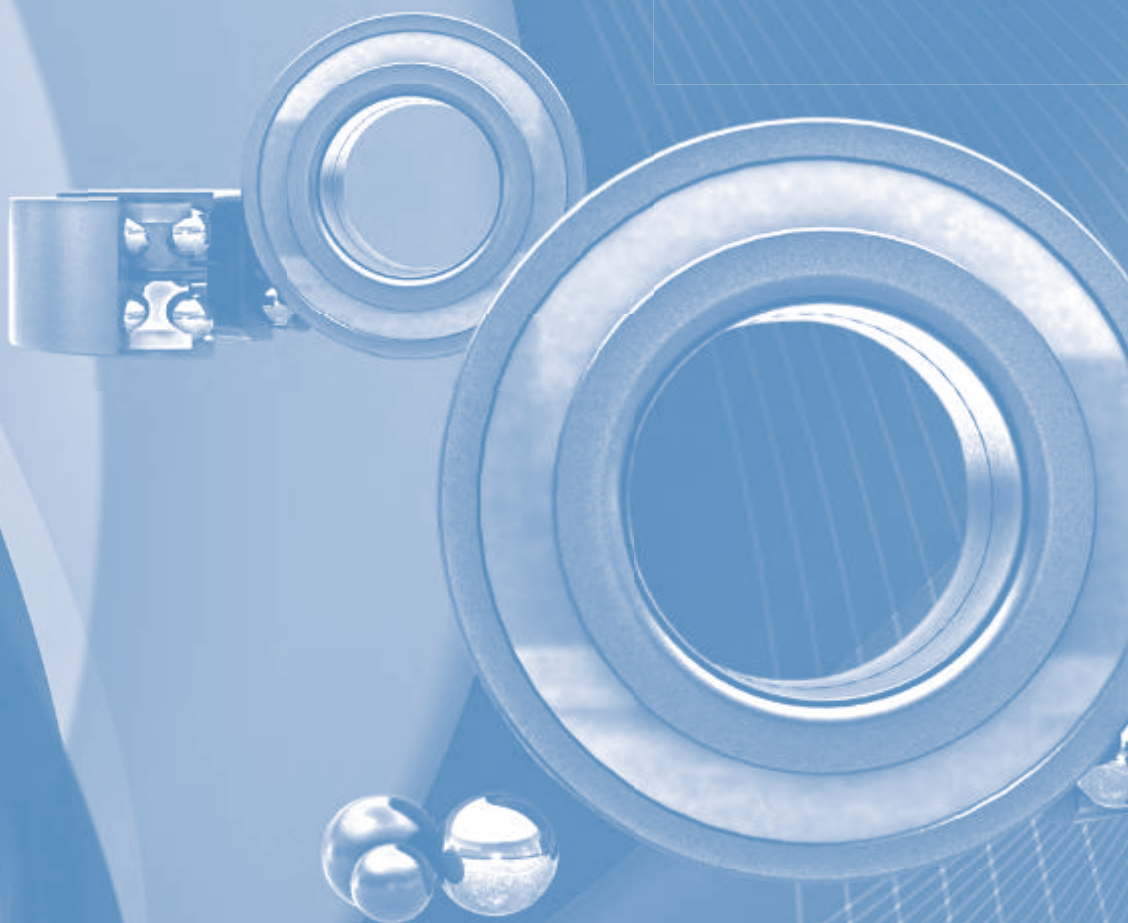

Product overview / Introducción

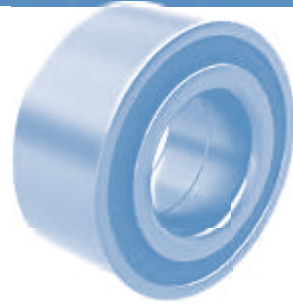

Description

Double row angular contact ball bearings can accommodate high radial loads as well as high axial loads, in both directions. They provide stiff bearing arrangements, are able to accommodate tilting moments and are suitable for bearings arrangements where rigid axial guidance is required.

Advantages:

- Universal applicability
- High radial and axial load carrying capacity in both direction
- Quiet operation

Double row angular contact ball bearings as well as other Fersa are designed to comply with the highest working standards, since bearing counts on totality of production process that enables us to offer highest quality bearings for European and worldwide automotive market.

Design

Double row angular contact ball bearings are units with robust inner and outer rings, balls and plastic cages, steel cages or brass cages.

Descripción

Los rodamientos de bolas de contacto angular doble hilera pueden soportar cargas radiales grandes en ambos sentidos. Permiten disposiciones rígidas, se adaptan a momentos de vuelco, y son indicados para disposiciones de rodamientos donde se requiere una guía radial rígida.

Ventajas:

- Aplicaciones universales
- Alta capacidad de carga radial y axial en ambos sentidos
- Funcionamiento silencioso

Los rodamientos de bolas de contacto angular de doble hilera, así como otros rodamientos de Fersa están diseñados para soportar condiciones extremas de trabajo, siendo los rodamientos ensamblados en los principales fabricantes del mercado del automóvil Europeo y mundial.

Diseño

Los rodamientos de bolas de contacto angular son unidades con aros interiores y exteriores robustos, bolas, y jaulas de plástico, acero o latón.

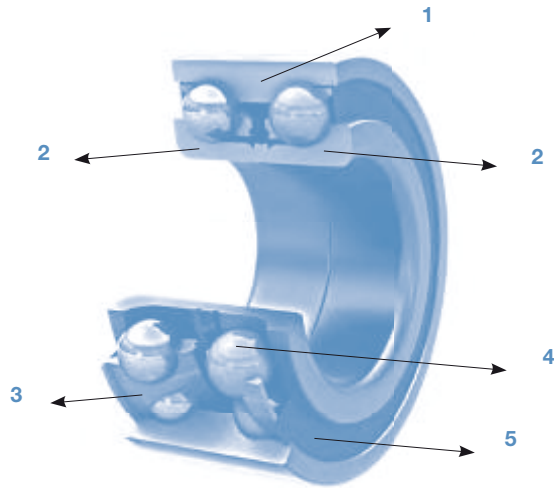

- 1. Outer Ring
- 2. Inner Ring
- 3. Cage
- 4. Ball
- 5. Seal

- 1. Aro exterior
- 2. Aro interior
- 3. Jaula
- 4. Bola
- 5. Retén

Double row angular contact ball bearings correspond to a pair of single row contact ball bearing in "O" arrangement, but take up less space.

These bearings have 32°-36° contact angle and are available in open and sealed designs. Sealed bearings are lubricated for life, are maintenance-free and permit particularly bearing arrangements.

Double row angular contact ball bearings from Fersa are special bearings and belong to series F16000.

Los rodamientos de bolas de contacto angular de doble hilera corresponden a un par de rodamientos de bolas de contacto de una hilera en disposición "O", pero ocupan menos espacio.

Estos rodamientos tienen un ángulo de contacto de 32° -36° y están disponibles con o sin retenes. Los rodamientos con retén están lubricados durante toda la vida del rodamiento, no requieren mantenimiento y permiten disposiciones particulares de rodamientos.

Los rodamientos de bolas de contacto angular de doble hilera de Fersa, son rodamientos especiales y corresponden a la serie F16000.



Bearing features / Características del rodamiento

Bearing Tolerances

Double row angular contact ball bearings are produced according to normal tolerances. The values for tolerances correspond to ISO 492:2002.

Tolerancia del rodamiento

Los rodamientos de bolas de contacto angular de doble hilera se fabrican según las tolerancias normales. Los valores corresponden a la Normativa ISO 492:2002.

Normal tolerances for radial bearings / Tolerancias normales para rodamientos radiales de bolas

Bore diameter / Diámetro interno

d		Δ_{dmp}		V_{dp}			V_{dmp}	K_{ia}
over	incl	high	low	series 7,8,9	series 0,1	series 2,3,4		
mm		μm		max	max	max	max	max
				μm			μm	μm
-	2,5	0	-8	10	8	6	6	10
2,5	10	0	-8	10	8	6	6	10
10	18	0	-8	10	8	6	6	10
18	30	0	-10	13	10	8	8	13
30	50	0	-12	15	12	9	9	15
50	80	0	-15	19	19	11	11	20
80	120	0	-20	25	25	15	15	25
120	180	0	-25	31	31	19	19	30

Outer diameter / Diámetro externo

D		Δ_{Dmp}		V_{Dp}			V_{Dmp}	K_{ea}
over	incl	high	low	series 7,8,9	series 0,1	series 2,3,4		
mm		μm		max	max	max	max	max
				μm			μm	μm
6	18	0	-8	10	8	6	6	15
18	30	0	-9	12	9	7	7	15
30	50	0	-11	14	11	8	8	20
50	80	0	-13	16	13	10	10	25
80	120	0	-15	19	19	11	11	35
120	150	0	-18	23	23	14	14	40
150	180	0	-25	31	31	19	19	45
180	250	0	-30	38	38	23	23	50

Bearings width / Anchura del rodamiento

d		Δ_{Bs}		V_{Bs}
over	incl	high	low	max
mm		μm		μm
-	2,5	0	-120	10
2,5	10	0	-120	10
10	18	0	-120	10
18	30	0	-120	13
30	50	0	-150	15
50	80	0	-200	19
80	120	0	-250	25
120	180	0	-300	31

Double row angular contact ball bearings can be also produced with non-standard tolerances, according to its specific application.

Internal clearance

Bearing clearance is the measurement by which one bearing ring can be displaced in relation to the other in radial or axial direction from one end position to the other.

Internal clearance for non standard double row angular contact ball bearings is normally defined according to application. Depending on the application the internal clearance could be between 30 and 150 μm .

Variables as fitting tolerances and mounting torque during assembly are essential to assure that the bearing will reach the best performance under operation.

Speed

The maximum operating speed of double row angular contact ball bearings may be limited by several criteria. Most frequently, the decisive criteria is the operating temperature, which rises with increasing speed. Other criteria for permissible operating speed may be a unreliable lubricant supply of rolling and sliding contact areas due to strong centrifugal forces or greatly changed rolling kinematics of rolling elements.

Los rodamientos de bola de contacto angular también se fabrican con tolerancias especiales, de acuerdo con la aplicación específica del rodamiento.

Juego interno

El juego del rodamiento es la distancia a través de la cual un rodamiento puede desplazarse en relación al otro en el sentido axial o radial desde la posición en un extremo al otro.

El juego interno para los rodamientos de bolas de contacto angular de doble hilera fuera del estándar se define de acuerdo a la aplicación. En función de la aplicación el juego interno puede estar entre 30 and 150 μm .

VARIABLES como tolerancias de ajuste y torsión durante el montaje son esenciales para asegurar que el rodamiento funcionará al máximo cuando este operativo.

Velocidad

La velocidad máxima operativa de los rodamientos de bolas de contacto angular de doble hilera se puede ver limitada por varios criterios. Por regla general el factor decisivo es la temperatura funcional, que aumenta con la velocidad. Otros criterios de velocidad pueden ser una cantidad de lubricante de rotación y de deslizamiento incierta debido a importantes fuerzas centrífugas o cambios significativos de rotación de la viscosidad cinemática de los elementos de rotación.



Misalignment

Inaccuracies in the alignment of bearing locations must be taken into account. Misalignment arises when housing bores are not machined in one set. Angular misalignment of inner ring and outer ring axles are caused by larger shaft deflections and housing deformations.

Misalignment of the inner ring in relation to the outer ring of a double row angular contact ball bearing can only be adjusted by a force, which leads to an increase of ball loads and also to a reduction of the bearing service life. Any other misalignment of the bearing rings will result in a higher noise during operation.

Cages

Double row angular contact ball bearings are fitted with two injection molded snap-type cages of glass fibre reinforced polyamide 66 and are heat-stabilized. They are suitable for operating temperatures of up to 120°C.

Equivalent dynamic bearing load

$$P = F_r + 0.66 \times F_a \quad [\text{N}] \quad \text{when } F_a/F_r \leq 0,95$$

$$P = 0,6 \times F_r + 1,07 \times F_a \quad [\text{N}] \quad \text{when } F_a/F_r > 0,95$$

P = equivalent dynamic bearing load [N]

F_r = radial dynamic bearing load [N]

F_a = axial dynamic bearing load [N]

Equivalent static bearing load

$$P_o = F_o + 0,58 \times F_{o_a}$$

P = equivalent static bearing load [N]

F_r = radial static bearing load [N]

F_a = axial static bearing load [N]

Desalineación

Las imprecisiones de alineación de la posición del rodamiento deben tenerse en cuenta. La desalineación ocurre cuando los calibres de las cajas no están mecanizados en un conjunto. La desalineación angular de los ejes del aro interior y exterior se debe a desviaciones de ejes mayores y a las deformaciones de las cajas.

La desalineación del aro interior en relación al aro exterior de un rodamiento de bolas de contacto angular de doble hilera sol puede ajustarse por fuerza, lo que conlleva un incremento de la carga de las bolas, además de un desgaste de la vida operativa del rodamiento. Cualquier otra desalineación de los aros del rodamiento producirá un aumento del ruido durante el funcionamiento.

Jaulas

Los rodamientos de bolas de contacto angular se ajustan con dos jaulas de poliamida 66 reforzada de fibra de vidrio moldeada por inyección, y están estabilizados con calor. Son indicadas para ser utilizados en temperaturas de hasta 120°C.

Carga dinámica equivalente del rodamiento

$$P = F_r + 0.66 \times F_a \quad [\text{N}] \quad \text{cuando } F_a/F_r \leq 0,95$$

$$P = 0,6 \times F_r + 1,07 \times F_a \quad [\text{N}] \quad \text{cuando } F_a/F_r > 0,95$$

P = carga dinámica equivalente del rodamiento [N]

F_r = carga radial dinámica del rodamiento [N]

F_a = carga axial dinámica del rodamiento [N]

Carga estática equivalente del rodamiento

$$P_o = F_o + 0,58 \times F_{o_a}$$

P = carga estática equivalente del rodamiento [N]

F_r = carga radial estática del rodamiento [N]

F_a = carga axial estática del rodamiento [N]



05.1

DOUBLE ROW ANGULAR CONTACT BALL BEARINGS RODAMIENTOS DE BOLAS DE DOBLE HILERA DE CONTACTO ANGULAR

Type / Tipo

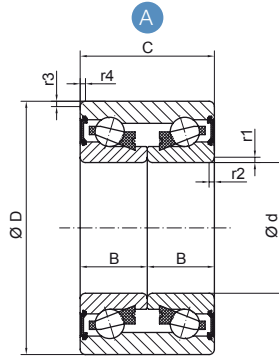
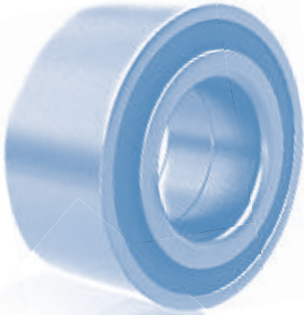

DIMENSIONS / DIMENSIONES										TYPE / TIPO	REFERENCES / REFERENCIAS
d		D		B		C		r1/r2 min	r3/r4 min		
mm	inch	mm	inch	mm	inch	mm	inch	mm	mm		
25,000	0,984	52,000	2,047	21,000	0,827	42,000	1,654	2,5	1,0	A	F 16129
		56,000	2,205	16,000	0,630	32,000	1,654	1,5	0,5	A	F 16004
27,000	1,063	---	---	25,000	0,984	67,600	2,661	3,0	---	D	F 16094
28,000	1,102	61,000	2,402	21,000	0,827	42,000	1,654	3,5	0,8	A	F 16077
		---	---	21,000	0,827	52,000	2,047	3,5	---	D	F 16095
30,000	1,181	60,030	2,363	18,500	0,728	37,000	1,457	2,8	0,3	A	F 16001
		60,030	2,363	18,500	0,728	37,000	1,457	2,8	---	B	F 16010
34,000	1,339	62,000	2,441	18,500	0,728	37,000	1,457	2,5	0,6	A	F 16018
		64,000	2,520	18,500	0,728	37,000	1,457	2,5	0,3	A	F 16019
		66,000	2,598	18,500	0,728	37,000	1,457	2,8	0,3	A	F 16020
		67,000	2,638	18,500	0,728	37,000	1,457	2,5	0,5	A	F 16083
35,000	1,378	64,000	2,520	18,500	0,728	37,000	1,457	3,0	0,3	A	F 16200
		65,000	2,559	17,500	0,689	35,000	1,378	2,8	0,6	A	F 16021
		66,000	2,598	16,000	0,630	32,000	1,260	2,8	0,3	A	F 16022
		66,000	2,598	16,500	0,650	33,000	1,457	2,8	0,3	A	F 16093
		66,000	2,598	18,500	0,728	37,000	1,457	2,8	0,3	A	F 16023
		68,000	2,677	18,500	0,728	37,000	1,457	2,8	0,6	A	F 16002
		68,000	2,677	18,500	0,728	37,000	1,299	2,8	0,6	A	F 16024
		72,000	2,835	17,000	0,669	34,000	1,339	3,0	0,5	A	F 16201
37,000	1,457	72,000	2,835	16,500	0,650	33,000	1,299	3,4	0,3	A	F 16026
		72,040	2,836	16,500	0,650	33,000	1,339	2,5	0,8	A	F 16027
		72,000	2,835	16,500	0,650	33,000	1,299	2,0	0,8	A	F 16029
		72,000	2,835	18,500	0,728	37,000	1,457	2,4	0,3	A	F 16030
		72,040	2,836	18,500	0,728	37,000	1,457	2,4	0,3	A	F 16031
37,990	1,496	74,000	2,913	22,500	0,886	45,000	1,772	3,0	0,3	A	F 16032
		---	---	22,500	0,886	45,000	1,772	2,8	---	D	F 16033
		74,020	2,914	18,000	0,709	33,000	1,299	3,0	0,6	A	F 16034
		72,000	2,835	20,000	0,787	40,000	1,299	2,5	0,8	A	F 16124
38,000	1,496	72,020	2,835	18,000	0,709	33,000	1,299	3,0	1,0	A	F 16068
		73,000	2,874	20,000	0,787	40,000	1,575	2,5	0,5	A	F 16117
		74,000	2,913	25,000	0,984	50,000	1,969	3,5	1,0	A	F 16058
38,100	1,500	70,000	2,756	18,500	0,728	37,000	1,457	3,0	0,8	A	F 16057
39,000	1,535	68,000	2,677	18,500	0,728	37,000	1,457	3,3	0,3	A	F 16035

Type / Tipo

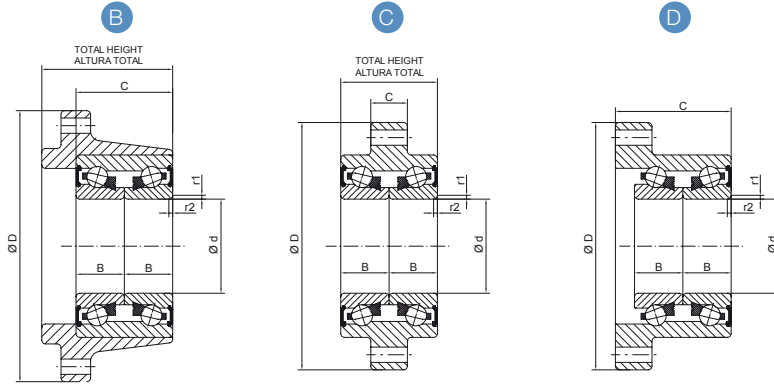

WEIGHT / PESO		SEALED / RETÉN	FLANGE Ø / Ø VALONA	TOTAL HEIGHT / ALTURA TOTAL	LOAD / CARGA		SPEED / VELOCIDAD		REFERENCES / REFERENCIAS
kg	lb				DYNAMIC / DINÁMICA	STATIC / ESTÁTICA	OIL / ACEITE	GREASE / GRASA	
					C	Co	na	ng	
					kN	kN	rpm	rpm	
0,360	0,792	SEALED	---	---	21,7	17,1	---	6200	F 16129
0,335	0,737	SEALED	---	---	36,0	26,5	---	5900	F 16004
1,365	3,003	SEALED	134,0	67,6	41,1	29,7	---	13000	F 16094
0,525	1,155	OPEN	---	---	38,2	29,5	9000	7000	F 16077
1,025	2,255	SEALED	ESP	52,0	38,2	29,3	---	12000	F 16095
0,410	0,902	SEALED	---	---	36,6	31,0	---	7000	F 16001
1,385	3,047	SEALED	117,0	61,3	38,1	29,9	---	7000	F 16010
0,405	0,891	SEALED	---	---	27,0	24,0	---	6000	F 16018
0,432	0,950	SEALED	---	---	40,0	33,0	---	6000	F 16019
0,475	1,045	SEALED	---	---	42,2	35,7	---	6000	F 16020
0,500	1,100	SEALED	---	---	46,0	37,6	---	6000	F 16083
0,415	0,913	SEALED	---	---	39,6	34,4	---	4800	F 16200
0,440	0,968	SEALED	---	---	39,8	33,7	---	6000	F 16021
0,425	0,935	SEALED	---	---	42,0	36,0	---	6000	F 16022
0,425	0,935	SEALED	---	---	43,0	36,2	---	4700	F 16093
0,510	1,122	SEALED	---	---	42,0	36,0	---	6000	F 16023
0,545	1,199	SEALED	---	---	42,0	36,0	---	5000	F 16002
0,530	1,166	SEALED	---	---	42,1	35,9	---	4600	F 16024
0,590	1,298	SEALED	---	---	43,3	36,2	---	4400	F 16201
0,545	1,199	SEALED	---	---	48,0	41,0	---	5000	F 16026
0,525	1,155	SEALED	---	---	49,4	39,9	---	4400	F 16027
0,560	1,232	SEALED	---	---	48,0	41,5	---	5000	F 16029
0,610	1,342	SEALED	---	---	48,5	41,5	---	5000	F 16030
0,575	1,265	SEALED	---	---	48,0	41,0	---	5000	F 16031
0,745	1,639	SEALED	---	---	48,0	41,0	---	5000	F 16032
2,000	4,400	SEALED	139,0	64,0	58,5	49,2	---	10000	F 16033
0,590	1,298	OPEN	---	---	48,2	41,7	7000	5000	F 16034
0,600	1,320	SEALED	---	---	48,2	41,4	---	4300	F 16124
0,565	1,243	OPEN	---	---	48,2	41,7	7000	5000	F 16068
0,650	1,430	SEALED	---	---	48,1	41,6	---	4300	F 16117
0,810	1,782	SEALED	---	---	48,1	41,6	---	4200	F 16058
0,550	1,210	SEALED	---	---	43,9	39,0	---	5000	F 16057
0,475	1,045	SEALED	---	---	39,5	36,0	---	5000	F 16035

05.1

DOUBLE ROW ANGULAR CONTACT BALL BEARINGS RODAMIENTOS DE BOLAS DE DOBLE HILERA DE CONTACTO ANGULAR

Type / Tipo

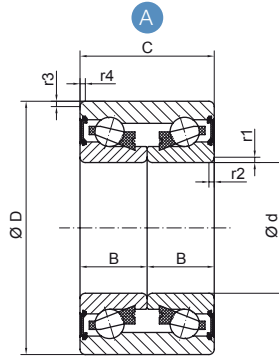
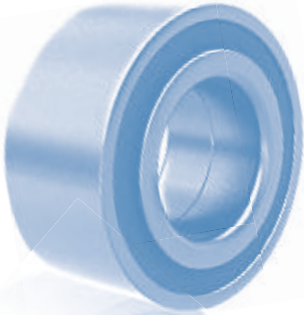

DIMENSIONS / DIMENSIONES										TYPE / TIPO	REFERENCES / REFERENCIAS
d		D		B		C		r1/r2 min	r3/r4 min		
mm	inch	mm	inch	mm	inch	mm	inch	mm	mm		
39,000	1,535	72,000	2,835	18,500	0,728	37,000	1,457	2,4	0,3	A	F 16036
		72,000	2,835	18,500	0,728	37,000	1,969	2,5	0,8	A	F 16110
		74,000	2,913	19,500	0,768	39,000	1,535	3,0	0,3	A	F 16037
		74,000	2,913	19,500	0,768	39,000	1,535	3,5	0,3	A	F 16037 (F 16096)
39,000/ 41,000	1,535/ 1,614	75,000	2,953	13,500/ 23,500	0,531/ 0,925	37,000	1,457	3,6	0,3	A	F 16038
39,980	1,574	108,000	4,252	16,000	0,630	17,000	0,669	3,5	1,0	C	F 16044
40,000	1,575	72,000	2,835	18,500	0,728	37,000	1,457	2,4	0,3	A	F 16039
		74,000	2,913	18,000	0,709	34,000	1,535	3,0	1,5	A	F 16091
		74,000	2,913	18,000	0,709	36,000	1,417	3,5	0,8	A	F 16080
		74,000	2,913	20,000	0,787	40,000	1,575	3,8	0,3	A	F 16040
		74,000	2,913	20,000	0,787	40,000	1,339	3,0	0,5	A	F 16089
		74,000	2,913	21,000	0,827	42,000	1,654	3,0	0,8	A	F 16079
		75,000	2,953	18,500	0,728	37,000	1,457	4,5	0,6	A	F 16055
		76,000	2,992	16,500	0,650	33,000	1,299	3,5	1,1	A	F 16198
		80,000	3,150	15,100	0,595	30,200	1,189	4,0	1,2	A	F 16042
		80,000	3,150	19,050	0,750	38,100	1,500	3,5	0,8	A	F 16043
		80,000	3,150	18,000	0,709	34,000	1,299	3,5	1,5	A	F 16090
		84,020	3,308	19,000	0,748	38,000	1,339	3,5	1,0	A	F 16066
		84,060	3,309	19,000/ 19,800	0,748/ 0,779	39,700	1,563	3,5	0,5	A	F 16108
		42,000	1,654	75,000	2,953	18,500	0,728	37,000	1,563	3,6	0,5
75,000	2,953			18,500	0,728	37,000	1,457	3,6	0,5	A	F 16046
76,000	2,992			16,500	0,650	33,000	1,299	3,0	0,8	A	F 16197
76,000	2,992			19,000	0,748	35,000	1,378	3,5	0,5	A	F 16081
76,000	2,992			19,500	0,768	39,000	1,535	3,5	0,8	A	F 16194
76,000	2,992			20,000	0,787	37,000	1,457	3,5	0,8	A	F 16195
80,000	3,150			18,500	0,728	37,000	1,457	2,4	0,3	A	F 16107
80,000	3,150			22,500	0,886	45,000	1,457	3,8	1,0	A	F 16088
80,030	3,151			21,000	0,827	42,000	1,654	3,5	1,0	A	F 16074
82,000	3,228			18,000	0,709	36,000	1,417	3,5	1,0	A	F 16048
84,000	3,307			19,500	0,768	39,000	1,535	3,5	1,0	A	F 16051
43,000	1,693	76,000	2,992	21,500	0,846	43,000	1,693	2,5	0,6	A	F 16196
		78,000	3,071	22,000	0,866	44,000	1,732	3,0	0,5	A	F 16193

Type / Tipo

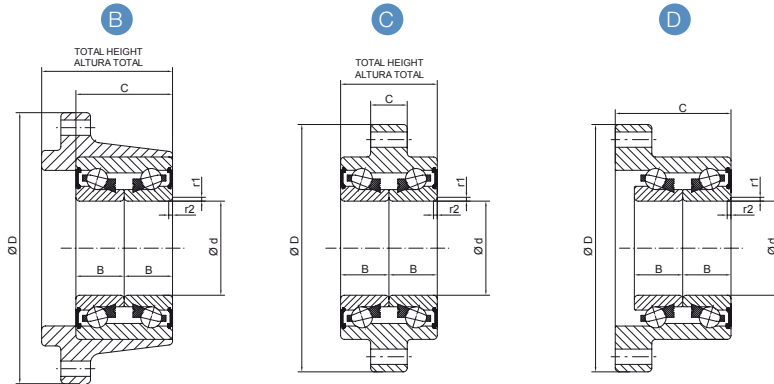

WEIGHT / PESO		SEALED / RETÉN	FLANGE Ø / Ø VALONA	TOTAL HEIGHT / ALTURA TOTAL	LOAD / CARGA		SPEED / VELOCIDAD		REFERENCES / REFERENCIAS
kg	lb				DYNAMIC / DINÁMICA	STATIC / ESTÁTICA	OIL / ACEITE	GREASE / GRASA	
					C	Co	na	ng	
					kN	kN	rpm	rpm	
0,545	1,199	SEALED	---	---	48,0	41,5	---	5000	F 16036
0,570	1,254	SEALED	---	---	48,0	42,2	---	4300	F 16110
0,650	1,430	SEALED	---	---	48,1	41,7	---	5000	F 16037
0,648	1,426	SEALED	---	---	48,1	41,7	---	4200	F 16037 (F 16096)
0,670	1,474	SEALED	---	---	50,2	45,2	---	5000	F 16038
1,095	2,409	SEALED	108,0	32,0	50,6	43,2	---	4000	F 16044
0,545	1,199	SEALED	---	---	48,0	42,0	---	5000	F 16039
0,595	1,309	OPEN	---	---	48,1	41,7	6800	5600	F 16091
0,615	1,353	SEALED	---	---	47,3	43,3	---	5000	F 16080
0,640	1,408	SEALED	---	---	48,0	42,0	---	5000	F 16040
0,670	1,474	SEALED	---	---	47,9	42,5	---	4200	F 16089
0,710	1,562	SEALED	---	---	47,3	43,3	---	5000	F 16079
0,640	1,408	SEALED	---	---	50,0	45,0	---	5000	F 16055
0,595	1,309	SEALED	---	---	50,4	44,6	---	4100	F 16198
0,610	1,342	OPEN	---	---	49,0	45,0	6000	4000	F 16042
0,790	1,738	SEALED	---	---	58,4	49,8	---	4000	F 16043
0,745	1,639	SEALED	---	---	55,0	49,6	---	4000	F 16090
0,970	2,134	SEALED	---	---	49,9	46,1	---	3800	F 16066
0,955	2,101	SEALED	---	---	61,3	54,0	---	3800	F 16108
0,580	1,276	SEALED	---	---	50,1	45,5	---	4100	F 16045
0,595	1,309	SEALED	---	---	50,0	45,0	---	5000	F 16046
0,550	1,210	SEALED	---	---	50,4	44,6	---	4000	F 16197
0,640	1,408	OPEN	---	---	50,1	45,2	7000	5000	F 16081
0,645	1,419	SEALED	---	---	50,4	44,6	---	4000	F 16194
0,645	1,419	SEALED	---	---	50,4	44,6	---	4000	F 16195
0,735	1,617	SEALED	---	---	64,8	51,1	---	3900	F 16107
0,910	2,002	SEALED	---	---	49,7	46,1	---	3900	F 16088
0,804	1,769	SEALED	---	---	50,6	43,1	---	4000	F 16074
0,774	1,703	SEALED	---	---	52,0	49,0	---	4000	F 16048
0,895	1,969	SEALED	---	---	50,0	46,0	---	4000	F 16051
0,700	1,540	SEALED	---	---	50,1	45,5	---	4000	F 16196
0,795	1,749	SEALED	---	---	50,2	45,5	---	3900	F 16193



05.1

DOUBLE ROW ANGULAR CONTACT BALL BEARINGS RODAMIENTOS DE BOLAS DE DOBLE HILERA DE CONTACTO ANGULAR

Type / Tipo

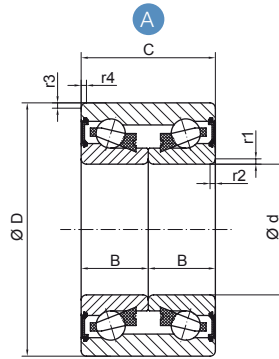
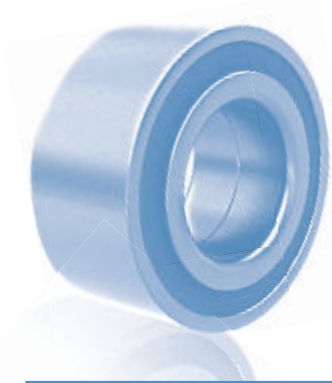

DIMENSIONS / DIMENSIONES										TYPE / TIPO	REFERENCES / REFERENCIAS
d		D		B		C		r1/r2 min	r3/r4 min		
mm	inch	mm	inch	mm	inch	mm	inch	mm	mm		
43,000	1,693	79,000	3,110	20,500	0,807	38,000	1,496	2,5	0,6	A	F 16052
		80,000	3,150	19,000	0,748	38,000	1,496	3,5	0,6	A	F 16086
		82,000	3,228	22,500	0,886	45,000	1,772	3,0	0,8	A	F 16078
43,000/ 45,000	1,692/ 1,771	82,000	3,228	18,500	0,728	37,000	1,457	3,5	1,0	A	F 16054
		85,000	3,346	14,500 / 22,500	0,570 / 0,885	37,000	1,457	4,0	1,0	A	F 16118
44,000	1,732	82,500	3,248	18,500	0,728	37,000	1,457	3,5	0,6	A	F 16056
44,990	1,771	84,070	3,310	19,500	0,768	39,000	1,535	3,5	0,8	A	F 16084
45,000	1,772	80,000	3,150	22,500	0,886	45,000	1,772	3,5	0,5	A	F 16085
		84,000	3,307	19,500	0,768	39,000	1,535	3,5	1,0	A	F 16059
		84,000	3,307	19,500	0,768	39,000	1,535	3,5	0,3	A	F 16082
		85,000	3,347	15,100	0,595	30,200	1,189	1,5	1,0	A	F 16063
		86,000	3,386	19,500	0,768	39,000	1,535	4,0	0,6	A	F 16123
		86,000	3,386	19,500	0,768	39,000	1,535	4,0	0,6	A	F 16128
		88,020	3,465	19,500	0,768	39,000	1,535	3,5	0,3	A	F 16121
47,000	1,850	81,000	3,189	26,500	1,043	53,000	2,087	4,0	0,8	A	F 16199
49,000	1,929	88,000	3,465	23,000	0,906	46,000	1,811	4,0	0,3	A	F 16109
50,000	1,969	90,000	3,543	20,000	0,787	40,000	1,811	1,5	0,5	A	F 16202
51,000	2,008	91,000	3,583	22,000	0,866	44,000	1,732	4,0	1,0	A	F 16076

Type / Tipo

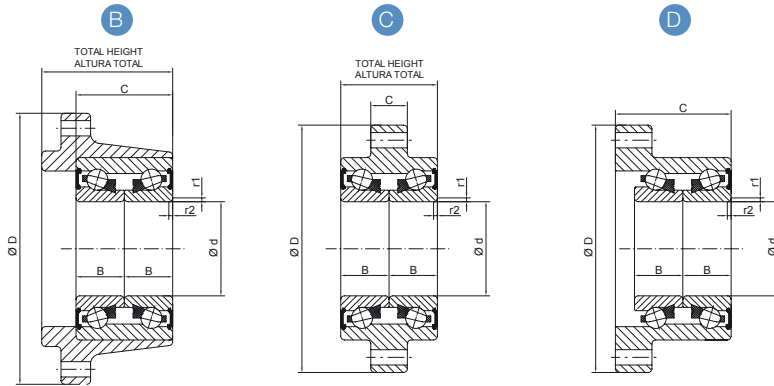

WEIGHT / PESO		SEALED / RETÉN	FLANGE Ø / Ø VALONA	TOTAL HEIGHT / ALTURA TOTAL	LOAD / CARGA		SPEED / VELOCIDAD		REFERENCES / REFERENCIAS
kg	lb				DYNAMIC / DINÁMICA	STATIC / ESTÁTICA	OIL / ACEITE	GREASE / GRASA	
					C	Co	na	ng	
					kN	kN	rpm	rpm	
0,705	1,551	SEALED	---	---	49,8	45,8	---	3900	F 16052
0,725	1,595	SEALED	---	---	61,3	54,0	---	3900	F 16086
0,965	2,123	SEALED	---	---	60,6	55,9	---	4000	F 16078
0,795	1,749	SEALED	---	---	50,0	46,0	---	4000	F 16054
0,875	1,925	SEALED	---	---	52,0	49,2	---	3700	F 16118
0,780	1,716	SEALED	---	---	52,0	49,0	---	4000	F 16056
0,850	1,870	SEALED	---	---	61,2	54,4	---	4000	F 16084
0,780	1,716	SEALED	---	---	58,0	51,7	---	3800	F 16085
0,820	1,804	SEALED	---	---	51,9	49,2	---	4000	F 16059
0,830	1,826	SEALED	---	---	61,2	54,4	---	4000	F 16082
0,625	1,375	SEALED	---	---	52,0	49,0	---	4000	F 16063
0,910	2,002	SEALED	---	---	68,5	60,6	---	3600	F 16123
0,920	2,024	SEALED	---	---	68,5	60,6	---	3600	F 16128
1,005	2,211	SEALED	---	---	68,5	60,6	---	3600	F 16121
0,940	2,068	SEALED	---	---	51,8	49,2	---	3700	F 16199
1,070	2,354	SEALED	---	---	71,3	66,3	---	3500	F 16109
0,930	2,046	SEALED	---	---	71,3	66,2	---	3400	F 16202
1,030	2,266	SEALED	---	---	70,7	67,6	---	4000	F 16076

05.2

STANDARD DOUBLE ROW ANGULAR CONTACT BALL BEARINGS RODAMIENTOS DE BOLAS DE DOBLE HILERA DE CONTACTO ANGULAR ESTÁNDAR

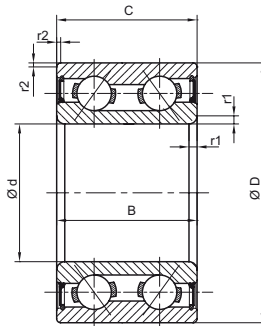
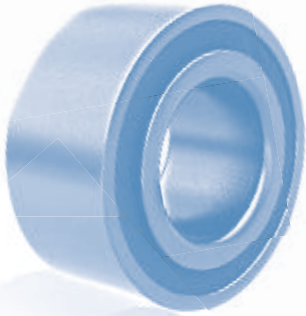

DIMENSIONS / DIMENSIONES										REFERENCES / REFERENCIAS
d		D		B		C		r1/r2 min	r3/r4 min	
mm	inch	mm	inch	mm	inch	mm	inch	mm	mm	
30,000	1,181	62,000	2,441	23,800	0,937	23,800	0,937	1,1	1,1	3206 B 2RS/C3
35,000	1,378	72,000	2,835	27,000	1,063	27,000	1,063	1,1	1,1	3207 B 2RS/C3
		80,000	3,150	34,900	1,374	34,900	1,374	1,5	1,5	3307 B 2RS/C3
40,000	1,575	80,000	3,150	30,200	1,189	30,200	1,189	1,5	1,5	3208 B 2RS/C3
50,000	1,969	90,000	3,543	30,200	1,189	30,200	1,189	2,0	2,0	3210 B 2RS/C3
60,000	2,362	110,000	4,331	36,500	1,437	36,500	1,437	2,3	2,3	3212 B 2RS/C3

WEIGHT / PESO		SEALED / RETÉN	LOAD / CARGA		SPEED / VELOCIDAD		REFERENCES / REFERENCIAS
kg	lb		DYNAMIC / DINÁMICA	STATIC / ESTÁTICA	OIL / ACEITE	GREASE / GRASA	
			C	Co	na	ng	
			kN	kN	rpm	rpm	
0,350	0,770	SEALED	23,7	17,4	8400	7000	3206 B 2RS/C3
0,460	1,012	SEALED	42,1	35,7	7200	6000	3207 B 2RS/C3
0,790	1,738	SEALED	47,2	33,0	6700	5600	3307 B 2RS/C3
0,640	1,408	SEALED	38,5	29,8	6400	5300	3208 B 2RS/C3
0,730	1,606	SEALED	38,0	32,0	5500	4600	3210 B 2RS/C3
1,380	3,036	SEALED	57,0	50,2	4500	3800	3210 B 2RS/C3



Four point angular contact ball bearings / Rodamientos de bolas de contacto angular de cuatro puntos

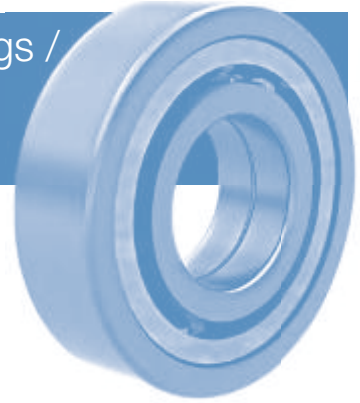

Description

Four-point angular contact ball bearings are designed to support predominantly axial loads in both directions. Radial loads can also be accommodated up to a certain level of axial load.

Since these bearings require less axial space, they become an attractive choice in case of room constraints.

Design

The inner ring is split, thus the bearing features a higher load carrying capacity, incorporating a large amount of balls.

The outer ring with ball and cage assembly can be fitted separately from the two inner ring halves.

Descripción

Los rodamientos de bolas de cuatro puntos de contacto angular están diseñados principalmente para soportar carga axial en ambos sentidos. La carga radial puede adaptarse hasta un determinado nivel de carga axial.

Ya que estos rodamientos requieren menos espacio axial, son una elección muy atractiva en el caso de tener un espacio limitado.

Diseño

El aro interior está partido, lo que permite una mayor incorporación de bolas y por lo tanto tiene una capacidad de carga mayor.

El aro exterior con bola y jaula pueden montarse por separado de las dos mitades del aro interior.



05.3

FOUR POINT ANGULAR CONTACT BALL BEARINGS RODAMIENTOS DE BOLAS DE CONTACTO ANGULAR DE CUATRO PUNTOS

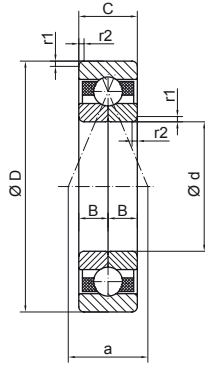
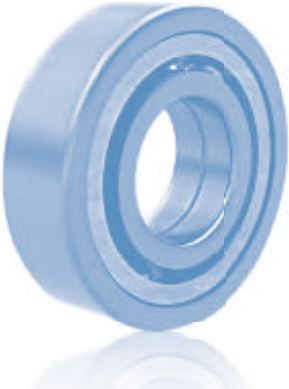

DIMENSIONS / DIMENSIONES											REFERENCES / REFERENCIAS
d		D		B		C		r1/r2 min	r3/r4 min	a	
mm	inch	mm	inch	mm	inch	mm	inch	mm	mm	mm	
40,000	1,575	80,000	3,150	9,000	0,354	18,000	0,709	1,1	1,1	42	QJ 208 FM
45,000	1,772	85,000	3,346	9,500	0,374	19,000	0,748	1,1	1,1	46	QJ 209 FM
		100,000	3,937	12,500	0,492	25,000	0,984	1,5	1,5	51	QJ 309 FM
55,000	2,165	100,000	3,937	10,500	0,413	21,000	0,827	1,5	1,5	54	QJ 211 FM
60,000	2,362	110,000	4,331	11,000	0,433	22,000	0,866	1,5	1,5	60	QJ 212 FM

Assembly / Montaje

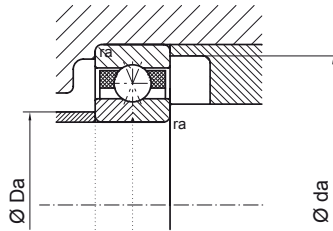

WEIGHT / PESO		ASSEMBLY / MONTAJE			LOAD / CARGA		SPEED / VELOCIDAD		REFERENCES / REFERENCIAS
					DYNAMIC / DINÁMICA	STATIC / ESTÁTICA	OIL / ACEITE	GREASE / GRASA	
kg	lb	da min	Da max	ra max	C	Co	na	ng	
		mm	mm	mm	kN	kN	rpm	rpm	
0,450	0,990	73,0	47,0	1,0	41	27,8	9500	---	QJ 208 FM
0,520	1,144	78,0	52,0	1,0	46,2	32,3	8500	---	QJ 209 FM
0,770	1,694	91,0	54,0	1,5	68,6	43,6	7500	---	QJ 309 FM
0,990	2,178	91,0	64,0	1,5	53,7	39,9	7000	---	QJ 211 FM
1,050	2,310	101,0	69,0	1,5	65,7	49,5	6300	---	QJ 212 FM

05.4

AIR CONDITIONING AIRE ACONDICIONADO

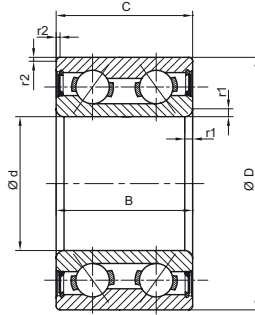
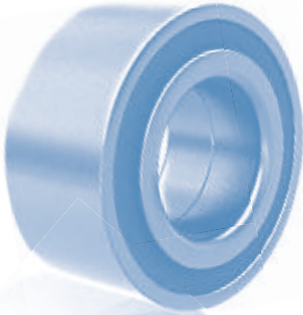

DIMENSIONS / DIMENSIONES										REFERENCES / REFERENCIAS
d		D		B		C		r1/r2 min	r3/r4 min	
mm	inch	mm	inch	mm	inch	mm	inch	mm	mm	
30,000	1,181	55,000	2,165	23,000	0,906	23,000	0,906	0,8	0,8	F 16098
		62,000	2,441	27,000	1,063	27,000	1,063	0,7	0,7	F 16104
		52,000	2,047	22,000	0,866	22,000	0,866	0,7	0,7	F 16097
35,000	1,378	50,000	1,969	20,000	0,787	20,000	0,787	0,5	0,5	F 16099
		52,000	2,047	22,000	0,866	22,000	0,866	1,0	0,6	F 16101
		55,000	2,165	20,000	0,787	20,000	0,787	0,7	0,6	F 16100
40,000	1,575	57,000	2,244	24,000	0,945	24,000	0,945	0,7	0,7	F 16189
		62,000	2,441	20,625	0,812	20,625	0,812	0,6	0,6	F 16103
		62,000	2,441	24,000	0,945	24,000	0,945	0,6	0,6	F 16102
		62,000	2,441	24,000	0,945	20,600	0,811	0,6	0,6	F 16190

WEIGHT / PESO		SEALED / RETEN	LOAD / CARGA		SPEED / VELOCIDAD		REFERENCES / REFERENCIAS
			DYNAMIC / DINÁMICA	STATIC / ESTÁTICA	OIL / ACEITE	GREASE / GRASA	
kg	lb	da min	C	Co	na	ng	
		mm	kN	kN	rpm	rpm	
0,200	0,440	SEALED	18,4	13,8	9100	7500	F 16098
0,340	0,748	SEALED	27,3	18,9	8400	7000	F 16104
0,155	0,341	SEALED	16,6	12,3	9100	7500	F 16097
0,090	0,198	SEALED	10,3	9,0	9100	7500	F 16099
0,125	0,275	SEALED	13,2	11,2	8900	7400	F 16101
0,140	0,308	SEALED	14,3	11,8	8600	7100	F 16100
0,150	0,330	SEALED	12,3	10,6	7900	6600	F 16189
0,190	0,418	SEALED	16,8	14,7	7500	6300	F 16103
0,220	0,484	SEALED	16,8	14,7	7500	6300	F 16102
0,195	0,429	SEALED	16,7	14,6	7500	6300	F 16190



06

Thrust ball bearings

Rodamientos axiales de bolas

06.0	Technical introduction / Introducción técnica	234
06.1	Thrust ball bearings / Rodamientos axiales de bolas	238
06.2	Clutch release bearing / Rodamientos de embrague	240



Product overview / Introducción



Description

Thrust ball bearings can support comparatively high axial loads, in one direction. They cannot be subjected to radial loads.

The bearings are not self-retainer, thus the mounting is simple as the washer, ball and cage assemblies can be mounted separately.

They require minimum axial loads for optimum operation.

Design

Thrust ball bearings have the following features:

- Shaft washer.
- Housing washer.
- Balls.
- Cage thrust assembly.

Descripción

Los rodamientos de bolas axiales pueden soportar grandes cargas axiales en un sentido. No pueden soportar cargas radiales.

Los rodamientos son separables de modo que el montaje es sencillo, ya que la arandela, la bola y la jaula se pueden montar por separado.

Requieren un mínimo de carga axial para un funcionamiento óptimo.

Diseño

Los rodamientos de bola axiales consisten en:

- Aro del eje.
- Aro del alojamiento.
- Bolas.
- Jaulas.

Bearing features / Características del rodamiento

Tolerances

Fersa supplies thrust ball bearings manufactured in NORMAL precision class according to ISO 492 and ISO199 norms.

Tolerancias

Fersa suministra rodamientos de bolas axiales en clase de precisión NORMAL de acuerdo a la Normativa ISO 492 y a la Normativa ISO 199.

Normal tolerances for thrust bearings / Tolerancias normales para rodamientos de bolas axiales

Bore diameter / Diámetro interior

d		Δ_{dmp}		V_{dp}	S_i
over	incl	high	low	max	max
mm		μm		μm	μm
-	18	0	-8	6	10
18	30	0	-10	8	10
30	50	0	-12	9	10
50	80	0	-15	11	10
80	120	0	-20	15	15
120	180	0	-25	19	15

Outer diameter / Diámetro exterior

D		Δ_{Dmp}		V_{Dp}	S_e
over	incl	high	low	max	max
mm		μm		μm	μm
-	30	0	-13	10	10
30	50	0	-16	12	10
50	80	0	-19	14	10
80	120	0	-22	17	15
120	180	0	-25	19	15
180	250	0	-30	23	20

Bearing width / Anchura del rodamiento

d		Δ_{Ts}	
over	incl	high	low
mm		μm	
-	30	20	-250
30	50	20	-250
50	80	20	-300
80	120	25	-300
120	180	25	-400
180	250	30	-400



Misalignment

Thrust ball bearings with flat housing washers do not permit angular misalignment between the support surfaces in the housing and on the shaft. No misalignment between the shaft and housing can be accommodated.

Speed

Thrust ball bearings are suitable for low and medium operating speeds. The ISO15312 Standard does not give speed references for these bearings.

Cages

Thrust ball bearings provided by Fersa are normally fitted with pressed steel cages as standard.

Equivalent dynamic bearing load

Thrust ball bearings can support only pure axial loads, therefore:

$$P = F_a$$

Equivalent static bearing load

Thrust ball bearings can support only pure axial loads, thus the following applies:

$$P_0 = F_a$$

Desalineación

Los rodamientos de bolas axiales con los aros del alojamiento plano no permiten la desalineación angular entre superficies de apoyo en el alojamiento y en el eje. La desalineación entre el eje y el alojamiento tampoco se permite.

Velocidad

Los rodamientos de bolas axiales son indicados para funcionar a velocidades bajas y medias. La Normativa ISO15312 no indica referencias de velocidades para estos rodamientos.

Jaulas

Los rodamientos de bolas axiales suministrados por Fersa se fabrican normalmente con jaulas estampadas de acero.

Carga dinámica equivalente de rodamiento

Los rodamientos de bolas axiales pueden soportar únicamente cargas axiales, por lo tanto:

$$P = F_a$$

Carga estática equivalente de rodamiento

Los rodamientos de bolas axiales pueden soportar únicamente cargas axiales, por lo tanto:

$$P_0 = F_a$$



06.1

THRUST BALL BEARINGS RODAMIENTOS AXIALES DE BOLAS

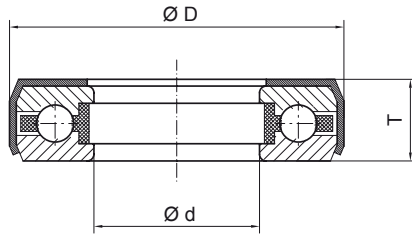

DIMENSIONS / DIMENSIONES						WEIGHT / PESO		REFERENCES / REFERENCIAS
d		D		T		kg	lb	
mm	inch	mm	inch	mm	inch			
12,200	0,480	36,600	1,441	11,000	0,433	0,050	0,110	F 15034
14,200	0,559	36,600	1,441	11,000	0,433	0,047	0,103	F 15033
38,090	1,500	67,300/72,500	2,649/2,854	18,200	0,717	0,260	0,572	F 15091
41,500	1,634	66,000	2,598	16,000	0,630	0,200	0,440	F 15004
		72,200	2,843	21,400	0,843	0,335	0,737	F 15064
52,400	2,063	83,800/89,000	3,299/3,503	20,300	0,799	0,360	0,792	F 15057
		86,000/91,000	3,385/3,582	20,550	0,809	0,376	0,827	F 15031
63,500	2,500	99,900/105,000	3,933/4,133	23,000	0,906	0,600	1,320	F 15058
65,000	2,559	111,700/113,600	4,397/4,472	22,100	0,870	0,660	1,452	F 15060
69,840	2,750	112,200/113,800	4,811/4,480	22,100	0,870	0,602	1,324	F 15059



Clutch release bearing / Rodamientos de embrague



Description

Clutch release bearings are self aligning bearing types. They are designed to control certain clutch conditions associated with the misalignment of components.

They operate against the clutch spring in order to connect/disconnect the engine from the transmission. It's controlled by the driver operating the clutch pedal.

Design

The special design of the clutch release bearings permit maximum speeds at maximum loads. The design has also been proven to have a very long life span. Anti-rotation feature prevents rotation damage to carrier in constant running applications.

The clutch release bearing features:

- Two thrust-race rings.
- Ball assembly.
- Sheet-steel retainer.
- Axial inner ring.
- Multipurpose grease for life lubrication.

Descripción

Los rodamientos de embrague son tipos de rodamientos auto alineantes. Están diseñados para controlar ciertas condiciones de embrague asociadas con la desalineación de los componentes.

Los rodamientos funcionan contra el muelle del embrague para conectar/desconectar el motor de la transmisión y lo controla el conductor al accionar el pedal de embrague.

Diseño

El diseño especial de los rodamientos de embrague permite una velocidad máxima de carga. El rodamiento se diseña para una vida útil larga. La característica anti-rotación previene la aparición de daños en las aplicaciones con giro constante.

El rodamiento de embrague tiene las siguientes características:

- Dos aros axiales.
- Conjunto de Bolas.
- Tapa de acero-chapa.
- Aro axial interno.
- Grasa multifuncional que evite la relubricación.



06.2

CLUTCH RELEASE BEARING RODAMIENTOS DE EMBRAGUE

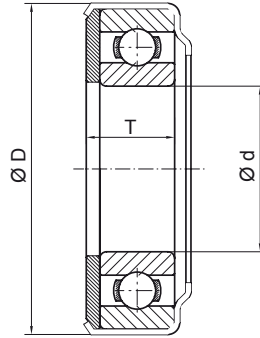

DIMENSIONS / DIMENSIONES						WEIGHT / PESO		REFERENCES / REFERENCIAS
d		D		T		kg	lb	
mm	inch	mm	inch	mm	inch			
16,300	0,642	56,000	2,205	9,000	0,354	0,070	0,154	F 15052
46,030	1,812	73,660	2,900	15,850	0,624	0,250	0,550	F 18012
		73,660	2,900	18,000	0,709	0,275	0,605	F 18013
55,000	2,165	91,500	3,602	25,000	0,984	0,535	1,177	F 15141
60,000	2,362	96,500	3,799	25,600	1,008	0,625	1,375	F 15140
		96,500	3,799	29,600	1,165	0,760	1,672	F 15139
		112,000	4,409	33,000	1,299	1,200	2,640	F 15005
63,500	2,500	102,000	4,016	20,570	0,810	0,550	1,210	F 18031
		103,000	4,055	21,400	0,843	0,600	1,320	F 15118
75,000	2,787	117,000	4,606	32,000	1,260	0,990	2,178	F 15070
65,000	2,559	96,500	3,799	22,500	0,886	0,420	0,924	F 15209
		101,700	4,004	21,750	0,856	0,440	0,968	F 15211
106,000	4,173	140,000	5,512	21,000	0,827	0,695	1,529	F 18028
		140,000	5,512	25,000	0,984	0,730	1,606	F 15210



07

Cylindrical roller bearings

Rodamientos cilíndricos

07.0	Technical introduction / Introducción técnica	246
07.1	Standard cylindrical bearings / Rodamientos cilíndricos estándar	252
07.2	Special cylindrical bearings / Rodamientos cilíndricos especiales	256

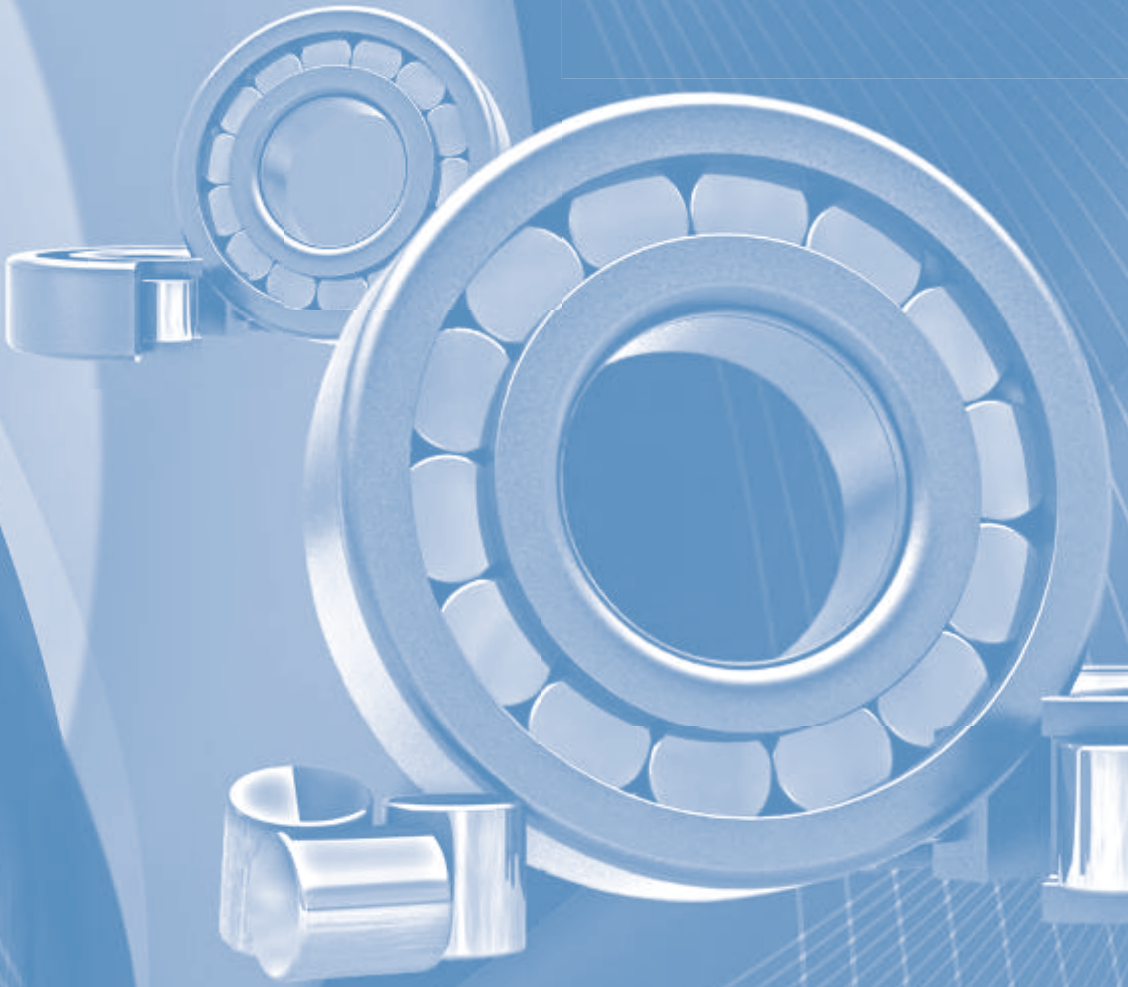

Product overview / Introducción

Description

Cylindrical roller bearings feature high radial load capacity due to the fact that raceways and rollers are in linear contact. These bearings are well-suited for applications requiring heavy radial and impact loading.

They are also appropriate for high-speed applications, in that they can be machined very precisely due to their structure.

Both inner or outer rings could be separated, which makes the assembly or disassembly easier. An interference assembly is also possible.

Design

The cylindrical roller bearing can be manufactured in different arrangements, depending on the allocation of ring flanges.

Descripción

Los rodamientos de rodillos cilíndricos tienen una gran capacidad de carga radial debido al contacto de línea entre rodillos y caminos de rodadura. Estos rodamientos son indicados para las aplicaciones que requieren cargas radiales y de impacto.

También son indicados para aplicaciones de alta velocidad, en las que se pueden mecanizar con mucha precisión gracias a su estructura.

Tanto los anillos exteriores como interiores pueden separarse para facilitar el montaje o desmontaje. Un montaje por interferencia también es posible.

Diseño

Se pueden fabricar rodamientos de rodillos cilíndricos en diferentes modelos, según la disposición de las pestañas de los aros:

Standard cylindrical bearings / Rodamientos cilíndricos estándar



NU-type bearings have the following features:

- Two-flanged outer rings.
- Flat inner ring.
- Separable components.
- Adjustment with interference is possible.

Características de los rodamientos tipo NU:

- Dos pestañas de aro exterior.
- Sin pestaña en el aro interior.
- Componentes separables.
- Ajuste con interferencia es posible.



N-type bearings have the following features:

- Two-flanged inner rings.
- Flat outer ring.
- Separable components.
- Adjustment with interference is possible.

Both NU and N executions exhibit their best performance when used as free side bearings since they adjust to the shaft's axial movement relative to the housing position.

Características de los rodamientos tipo N:

- Dos pestañas de aro interior.
- Sin pestaña en el aro exterior.
- Componentes desmontables.
- Ajuste con interferencia es posible.

Los diseños NU y N dan mejor resultado cuando se utilizan como rodamientos de lado libre, ya que se adaptan al movimiento axial del eje en relación a la posición de la caja.



NUP-type bearings have the following features:

- Two-flanged outer ring.
- One-flanged inner ring.
- Separable flanged washer.

The NUP bearings can carry a certain degree of axial loads in both directions.

Características de rodamientos tipo NUP:

- Dos pestañas en el aro exterior.
- Una pestaña en el aro interior.
- Arandela desmontable.

Los rodamientos NUP pueden soportar un cierto grado de carga axial en ambos sentidos.



NJ-type bearings have the following features:

- Two-flanged outer ring.
- One-flanged inner ring.

The NJ bearings can withstand axial load in just one direction

Características de los rodamientos tipo NJ:

- Dos pestañas en el aro exterior.
- Una pestaña en el aro interior.

Los rodamientos NJ pueden soportar cargas axiales en un sentido. .

Special cylindrical bearings / Rodamientos cilíndricos especiales

Fersa also manufactures specially designed cylindrical roller bearings:

The A type, and NR type characteristics are:

- Similar design than NJ type
- Snap ring groove located on the outer ring.

The B type, characteristics are:

- Similar design than NUP type.
- Outer ring with external flange.

Además, Fersa fabrica especiales rodamientos cilíndricos especiales:

Tipo A, y tipo NR caracterizados por:

- Diseño similar al tipo NJ.
- Anillos elásticos de ranura en el anillo exterior.

Tipo B, caracterizado por:

- Diseño similar tipo NUP.
- Anillo exterior con pestaña externa.

Bearing features / Características del rodamiento

Tolerances

Fersa supplies cylindrical roller bearings manufactured in NORMAL precision class according to ISO 492 and ISO 199 Standards

Tolerancias

Fersa suministra rodamientos cilíndricos fabricados con precisión clase NORMAL de acuerdo con la Normativa ISO 492 e ISO 199.

Normal tolerances for radial bearings / Tolerancias normales para rodamientos radiales

Bore diameter / Diámetro interior

d		Δ_{dmp}		V_{dp}			V_{dmp}	K_{ia}
over	incl	high	low	series 7,8,9	series 0,1	series 2,3,4		
mm		μm		max	max	max	max	max
				μm			μm	μm
-	2,5	0	-8	10	8	6	6	10
2,5	10	0	-8	10	8	6	6	10
10	18	0	-8	10	8	6	6	10
18	30	0	-10	13	10	8	8	13
30	50	0	-12	15	12	9	9	15
50	80	0	-15	19	19	11	11	20
80	120	0	-20	25	25	15	15	25
120	180	0	-25	31	31	19	19	30

Outer diameter / Diámetro exterior

D		Δ_{Dmp}		V_{Dp}			V_{Dmp}	K_{ea}
over	incl	high	low	series 7,8,9	series 0,1	series 2,3,4		
mm		μm		max	max	max	max	max
				μm			μm	μm
6	18	0	-8	10	8	6	6	15
18	30	0	-9	12	9	7	7	15
30	50	0	-11	14	11	8	8	20
50	80	0	-13	16	13	10	10	25
80	120	0	-15	19	19	11	11	35
120	150	0	-18	23	23	14	14	40
150	180	0	-25	31	31	19	19	45
180	250	0	-30	38	38	23	23	50

Bearing width / Anchura de rodamiento

d		Δ_{Bs}		V_{Bs}
over	incl	high	low	max
mm		μm		μm
18	30	0	-120	13
30	50	0	-150	15
50	80	0	-200	19
80	120	0	-250	25
120	180	0	-300	31

Misalignment

Fersa produces cylindrical roller bearings with modified geometry to minimize contact stresses between rollers and ring raceways.

The ability of single row cylindrical roller bearings to accommodate angular misalignment of the inner ring with regards to the outer ring is limited between 2 and 4 angular minutes, depending also on bearing type and specification.

Internal clearance

Fersa single row cylindrical roller bearings are manufactured with normal radial clearance as standard, but most of the references are also available with C3 and C4 radial internal clearance. The values for clearance are in accordance with ISO 5753 norm.

Radial internal clearance / Juego radial interno

Bore diameter / Diámetro interior

d		Normal		C3		C4	
over	incl	min	max	min	max	min	max
mm		µm	µm	µm	µm	µm	µm
-	30	20	45	35	60	50	75
30	40	25	50	45	70	60	85
40	50	30	60	50	80	70	100
50	65	40	70	60	90	80	110
65	90	40	75	65	100	90	125
90	100	50	85	75	110	105	140
100	120	50	90	85	125	125	165

Speed

The limiting speeds are determined by certain criteria including the resistance of the cage or the form stability.

Cages

For single-row cylindrical roller bearings, Fersa can supply different cage design and materials.

- Pressed steel cage.
- Machined brass cage.
- Machined brass cage without rivets.

Desalineación

Fersa fabrica rodamientos de rodillos cilíndricos con geometría modificada para minimizar la tensión de contacto entre los rodamientos y las pistas de rodadura de anillos.

La capacidad del rodamiento de rodillo cilíndrico de una hilera para soportar la desalineación angular del aro interior con respecto al aro exterior está limitado a entre 2 y 4 minutos de arco, según la especificación y tipo de rodamiento.

Juego interno

Fersa fabrica los rodamientos de rodillos cilíndricos de una hilera con juego radial normal, pero la mayoría de las referencias también están disponibles con juego radial interno de C3 y C4. Los valores de juego radial cumplen con la Normativa ISO 5753.

Velocidad

Los límites de velocidad están determinados por ciertos datos de criterio que incluyen la resistencia de la jaula o la estabilidad.

Jaulas

Para los rodamientos de rodillos cilíndricos de una hilera, Fersa ofrece varios diseños y materiales de jaulas.

- Jaula de acero.
- Jaula mecanizada de latón.
- Jaula mecanizada de latón sin remaches.

07.1

STANDARD CYLINDRICAL BEARINGS RODAMIENTOS CILÍNDRICOS ESTÁNDAR



Type / Tipo

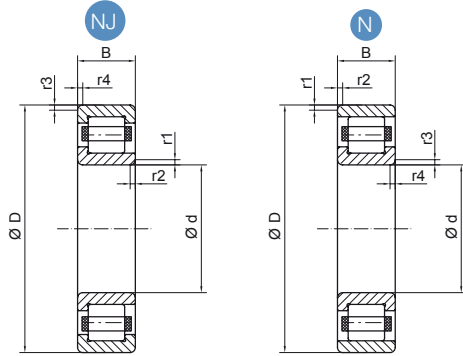

DIMENSIONS / DIMENSIONES								REFERENCES / REFERENCIAS
d		D		C		r1/r2 min	r3/r4 min	
mm	inch	mm	inch	mm	inch	mm	mm	
15,000	0,591	35,000	1,378	11,000	0,433	0,6	0,3	NU 202 F
20,000	0,787	52,000	2,047	15,000	0,591	1,1	0,6	NUP 304 F
25,000	0,984	52,000	2,047	18,000	0,709	1,0	0,6	NJ 2205 F
		52,000	2,047	18,000	0,709	1,0	0,6	NUP 2205 F
		62,000	2,441	17,000	0,669	1,1	1,1	NJ 305 F
		80,000	3,150	21,000	0,827	2,0	2,0	NJ 405 F
30,000	1,181	62,000	2,441	16,000	0,630	1,0	0,6	N 206 F
		62,000	2,441	16,000	0,630	1,0	0,6	NU 206 F
		62,000	2,441	16,000	0,630	1,0	0,6	NUP 206 F
		72,000	2,835	19,000	0,748	1,1	1,1	NJ 306 F
		72,000	2,835	27,000	1,063	1,1	1,1	NU 2306 F
		90,000	3,543	23,000	0,906	1,5	1,5	NJ 406 F
35,000	1,378	72,000	2,835	23,000	0,906	1,1	0,6	NU 2207 F
		80,000	3,150	21,000	0,827	1,5	1,1	N 307 F
		80,000	3,150	21,000	0,827	1,5	1,1	NJ 307 F
		80,000	3,150	21,000	0,827	1,5	1,1	NU 307 F
		80,000	3,150	31,000	1,220	1,5	1,1	NU 2307 F
40,000	1,575	68,000	2,677	15,000	0,591	1,0	0,6	NU 1008 F
		80,000	3,150	18,000	0,709	1,1	1,1	NU 208 F
		90,000	3,543	23,000	0,906	1,5	1,5	NJ 308 F
		90,000	3,543	23,000	0,906	1,5	1,5	NU 308 F
		90,000	3,543	23,000	0,906	1,5	1,5	NUP 308 F
45,000	1,772	85,000	3,346	19,000	0,748	1,1	1,1	NU 209 F
		85,000	3,346	19,000	0,748	1,1	1,1	NUP 209 F
		85,000	3,346	23,000	0,906	1,1	1,1	NU 2209 F
		100,000	3,937	25,000	0,984	1,5	1,5	NJ 309 F
		100,000	3,937	25,000	0,984	1,5	1,5	NU 309 F
		100,000	3,937	25,000	0,984	1,5	1,5	NUP 309 F
50,000	1,969	90,000	3,543	20,000	0,787	1,1	1,1	N 210 F
		90,000	3,543	20,000	0,787	1,1	1,1	NJ 210 F
		90,000	3,543	23,000	0,906	1,1	1,1	NU 2210 F
		110,000	4,331	27,000	1,063	2,0	2,0	NU 310 F
		110,000	4,331	27,000	1,063	2,0	2,0	NJ 310 F

Type / Tipo

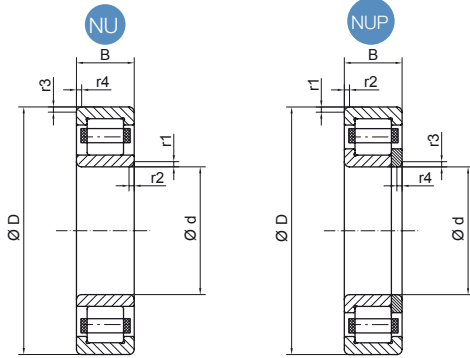

Assembly / Montaje

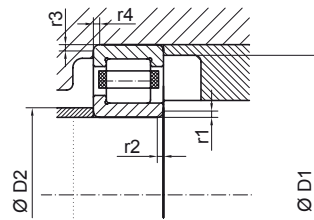

WEIGHT / PESO		ASSEMBLY / MONTAJE					LOAD / CARGA		SPEED / VELOCIDAD		REFERENCES / REFERENCIAS
		D1 min	D2 min	D2 max	r1/r2 max	r1/r2 max	DYNAMIC / DINÁMICA C	STATIC / ESTÁTICA Co	OIL / ACEITE na	GREASE / GRASA ng	
kg	lb	mm	mm	mm	mm	mm	kN	kN	rpm	rpm	
0,046	0,101	31,0	17,5	18,5	0,6	0,3	16,3	11,6	20000	16000	NU 202 F
0,160	0,352	45,0	27,0	---	1,1	0,6	37,8	27,7	14000	11000	NUP 304 F
0,170	0,374	46,0	30,0	30,0	1,0	0,6	39,1	32,7	13000	10000	NJ 2205 F
0,175	0,385	46,0	30,5	---	1,0	0,6	39,1	32,7	13000	10000	NUP 2205 F
0,250	0,550	55,0	32,0	32,0	1,1	1,1	41,5	32,2	11000	9000	NJ 305 F
0,600	1,320	70,0	35,0	---	2,0	2,0	50,8	38,6	9000	7000	NJ 405 F
0,220	0,484	57,0	35,5	54,0	1,0	0,6	47,6	39,2	11000	9000	N 206 F
0,250	0,550	56,5	34,0	36,0	1,0	0,6	47,6	39,2	11000	9000	NU 206 F
0,220	0,484	56,5	35,5	---	1,0	0,6	47,6	39,2	11000	9000	NUP 206 F
0,370	0,814	65,0	37,0	39,0	1,1	1,1	63,0	51,0	10000	8000	NJ 306 F
0,530	1,166	65,0	37,0	39,0	1,1	1,1	86,3	76,5	10000	8000	NU 2306 F
0,770	1,694	79,0	41,0	43,0	1,5	1,5	74,0	58,5	8000	6000	NJ 406 F
0,400	0,880	65,0	39,0	42,0	1,1	0,6	72,2	65,0	9000	7000	NU 2207 F
0,480	1,056	73,0	44,0	48,0	1,5	1,1	67,5	61,1	9000	7000	N 307 F
0,490	1,078	71,0	44,0	44,0	1,5	1,1	67,5	61,1	9000	7000	NJ 307 F
0,480	1,056	71,0	42,0	44,0	1,5	1,1	67,5	61,1	9000	7000	NU 307 F
0,720	1,584	71,0	42,0	44,0	1,5	1,1	109,0	100,6	9000	7000	NU 2307 F
0,230	0,506	63,0	43,0	45,0	1,0	0,6	31,2	28,0	12000	10000	NU 1008 F
0,380	0,836	73,0	47,0	48,0	1,1	1,1	66,4	56,8	8000	7000	NU 208 F
0,670	1,474	81,0	49,0	50,0	1,5	1,5	84,7	67,9	8000	6000	NJ 308 F
0,650	1,430	81,0	49,0	50,0	1,5	1,5	84,7	67,9	8000	6000	NU 308 F
0,680	1,496	81,0	49,0	---	1,5	1,5	84,7	67,9	8000	6000	NUP 308 F
0,430	0,946	78,0	52,0	53,0	1,1	1,1	74,7	67,6	8000	6000	NU 209 F
0,475	1,045	78,0	52,0	---	1,1	1,1	74,7	67,6	8000	6000	NUP 209 F
0,530	1,166	78,0	52,0	53,0	1,1	1,1	80,0	78,2	8000	6000	NU 2209 F
0,920	2,024	91,0	54,0	56,0	1,5	1,5	92,4	77,9	7000	5000	NJ 309 F
0,900	1,980	91,0	54,0	56,0	1,5	1,5	92,4	77,9	7000	5000	NU 309 F
0,950	2,090	91,0	54,0	---	1,5	1,5	92,4	77,9	7000	5000	NUP 309 F
0,480	1,056	83,0	57,0	59,0	1,1	1,1	78,2	73,1	7000	6000	N 210 F
0,500	1,100	83,0	57,0	57,0	1,1	1,1	78,2	73,1	7000	6000	NJ 210 F
0,570	1,254	83,0	57,0	57,0	1,1	1,1	89,7	88,0	7000	6000	NU 2210 F
1,150	2,530	99,0	61,0	63,0	2,0	2,0	124,0	107,2	6000	5000	NU 310 F
1,200	2,640	99,0	61,0	63,0	2,0	2,0	124,0	107,2	6000	5000	NJ 310 F



07.1

STANDARD CYLINDRICAL BEARINGS RODAMIENTOS CILÍNDRICOS ESTÁNDAR



Type / Tipo

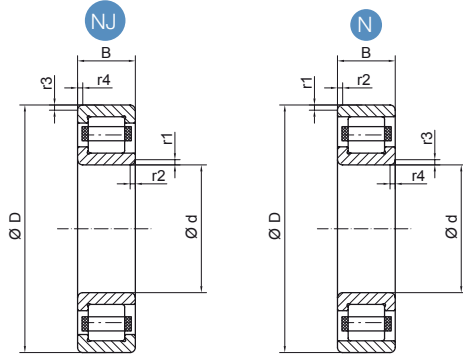

DIMENSIONS / DIMENSIONES								REFERENCES / REFERENCIAS
d		D		C		r1/r2 min	r3/r4 min	
mm	inch	mm	inch	mm	inch	mm	mm	
50,000	1,969	110,000	4,331	27,000	1,063	2,0	2,0	NUP 310 F
55,000	2,165	90,000	3,543	18,000	0,709	1,1	1,0	NU 1011 F
		100,000	3,937	21,000	0,827	1,5	1,1	N 211 F
		100,000	3,937	21,000	0,827	1,5	1,1	NUP 211 F
		100,000	3,937	25,000	0,984	1,5	1,1	NU 2211 F
60,000	2,362	120,000	4,724	29,000	1,142	2,0	2,0	NUP 311 F
		110,000	4,331	22,000	0,866	1,5	1,5	NUP 212 F
		110,000	4,331	28,000	1,102	1,5	1,5	NU 2212 F
65,000	2,559	110,000	4,331	28,000	1,102	1,5	1,5	NUP 2212 F
		130,000	5,118	31,000	1,220	2,1	2,1	NUP 312 F
		120,000	4,724	23,000	0,906	1,5	1,5	NUP 213 F
		120,000	4,724	31,000	1,220	1,5	1,5	NU 2213 F
70,000	2,756	110,000	4,331	20,000	0,787	1,1	1,0	NJ 1014
		125,000	4,921	31,000	1,220	1,5	1,5	NU 2214 F
		150,000	5,906	35,000	1,378	2,1	2,1	NUP 314 F
75,000	2,953	130,000	5,118	25,000	0,984	1,5	1,5	N 215 F
		130,000	5,118	25,000	0,984	1,5	1,5	NJ 215 F
		130,000	5,118	31,000	1,220	1,5	1,5	NU 2215 F
80,000	3,150	140,000	5,512	33,000	1,299	2,0	2,0	NU 2216 F
120,000	4,724	180,000	7,087	28,000	1,102	2,0	1,1	NJ 1024 F

Type / Tipo

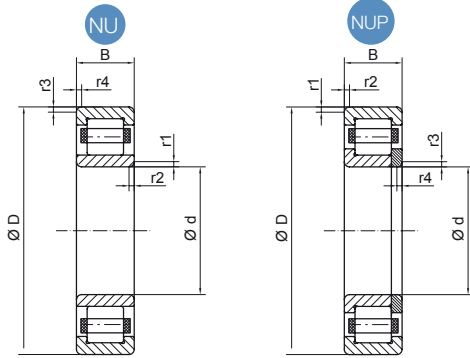

Assembly / Montaje

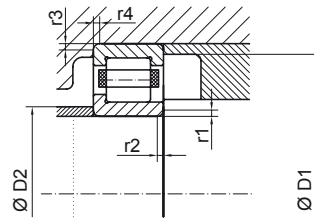

WEIGHT / PESO		ASSEMBLY / MONTAJE					LOAD / CARGA		SPEED / VELOCIDAD		REFERENCES / REFERENCIAS
		D1 min	D2 min	D2 max	r1/r2 max	r1/r2 max	DYNAMIC / DINÁMICA C	STATIC / ESTÁTICA Co	OIL / ACEITE na	GREASE / GRASA ng	
kg	lb	mm	mm	mm	mm	mm	kN	kN	rpm	rpm	
1,210	2,662	99,0	61,0	---	2,0	2,0	124,0	107,2	6000	5000	NUP 310 F
0,450	0,990	84,0	59,9	63,0	1,1	1,0	44,5	44,4	9000	7000	NU 1011 F
0,670	1,474	93,0	64,0	68,0	1,5	1,1	96,7	93,3	6000	5000	N 211 F
0,700	1,540	91,0	64,0	---	1,5	1,1	96,7	93,3	6000	5000	NUP 211 F
0,790	1,738	91,0	62,0	64,0	1,5	1,1	112,7	118,0	6000	5000	NU 2211 F
1,540	3,388	109,0	66,0	---	2,0	2,0	162,7	145,0	6000	4000	NUP 311 F
0,860	1,892	101,0	69,0	---	1,5	1,5	108,9	101,1	6000	5000	NUP 212 F
1,090	2,398	101,0	69,0	70,0	1,5	1,5	143,9	144,1	6000	5000	NU 2212 F
1,210	2,662	101,0	69,0	---	1,5	1,5	143,9	144,1	6000	5000	NUP 2212 F
1,930	4,246	118,0	72,0	---	2,1	2,1	147,2	129,4	5000	4000	NUP 312 F
1,105	2,431	111,0	74,0	---	1,5	1,5	129,9	123,9	5000	4000	NUP 213 F
1,400	3,080	111,0	74,0	76,0	1,5	1,5	154,3	161,0	5000	4000	NU 2213 F
0,700	1,540	105,0	74,0	82,0	1,1	1,0	72,6	76,7	7000	6000	NJ 1014
1,500	3,300	116,0	79,0	81,0	1,5	1,5	177,1	193,0	5000	4000	NU 2214 F
2,950	6,490	138,0	82,0	---	2,1	2,1	226,4	206,7	4000	4000	NUP 314 F
1,260	2,772	121,0	84,0	86,0	1,5	1,5	149,5	156,0	5000	4000	N 215 F
1,700	3,740	121,0	84,0	86,0	1,5	1,5	149,5	156,0	5000	4000	NJ 215 F
1,600	3,520	121,0	84,0	86,0	1,5	1,5	175,5	196,6	5000	4000	NU 2215 F
2,000	4,400	129,0	91,0	93,0	2,0	2,0	213,9	245,0	5000	4000	NU 2216 F
2,450	5,390	173,0	126,0	133,0	2,0	1,1	170,5	204,0	4000	3000	NJ 1024 F



07.2

SPECIAL CYLINDRICAL BEARINGS RODAMIENTOS CILÍNDRICOS ESPECIALES

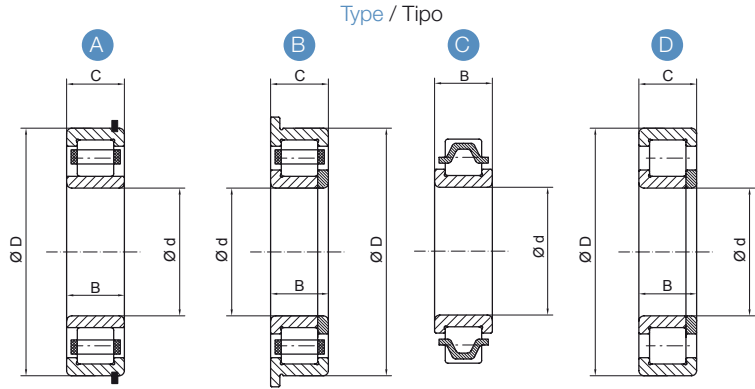

Type / Tipo

DIMENSIONS / DIMENSIONES								TYPE / TIPO	REFERENCES / REFERENCIAS
d		D		B		C			
mm	inch	mm	inch	mm	inch	mm	inch		
15,875	0,625	47,000	1,850	14,000	0,551	14,000	0,551	A	F 19055
24,000	0,945	---	---	17,000	0,669	---	---	F	F 19032
25,000	0,984	52,000	2,047	18,000	0,709	18,000	0,709	D	F 19023
		52,000	2,047	20,600	0,811	18,000	0,709	D	F 19004
25,500	1,004	---	---	21,000	0,827	21,000	0,827	A	F 19029
		---	---	19,000	0,748	---	---	C	F 19017
30,000	1,181	---	---	26,000	1,024	---	---	C	F 19019
		59,000	2,323	15,000	0,591	13,000	0,512	A	F 19024
		61,935	2,438	19,050	0,750	19,050	0,750	E	F 19031
		61,935	2,438	23,813	0,938	23,813	0,938	E	F 19045
		62,000	2,441	20,000	0,787	20,000	0,787	E	F 19025
		80,000	3,150	21,000	0,827	21,000	0,827	E	F 19078
		---	---	23,000	0,906	---	---	C	F 19075
		80,000	3,150	23,000	0,906	23,000	0,906	A	F 19043
34,993	1,378	---	---	---	---	25,000	0,984	C	F 19037
35,000	1,378	62,000	2,441	19,000	0,748	16,700	0,657	A	F 19066
		72,000	2,835	20,600	0,811	20,600	0,811	E	F 19035
		80,000	3,150	22,000	0,866	22,000	0,866	D	F 19020
		80,000	3,150	21,000	0,827	21,000	0,827	E	F 19077
		80,000	3,150	23,000	0,906	23,000	0,906	A	F 19012
		---	---	20,000	0,787	---	---	F	F 19048
36,000	1,417	---	---	---	---	---	---		
38,000	1,496	83,000	3,268	25,400	1,000	25,400	1,000	E	F 19067
		90,000	3,543	22,000	0,866	23,000	0,906	D	F 19014
		94,000	3,701	31,500	1,240	33,000	1,299	D	F 19076
		---	---	29,000	1,142	---	---	C	F 19065
40,000	1,575	90,000	3,543	23,000	0,906	23,000	0,906	D	F 19006
		90,000	3,543	23,000	0,906	23,000	0,906	E	F 19034
		90,000	3,543	24,900	0,980	27,000	1,063	D	F 19013
		90,000	3,543	25,000	0,984	25,000	0,984	E	F 19033
45,000	1,772	95,000	3,740	32,000	1,260	28,000	1,102	A	F 19015
		100,000	3,937	25,000	0,984	25,000	0,984	D	F 19002
		100,000	3,937	25,000	0,984	25,000	0,984	A	F 19003
		100,000	3,937	25,000	0,984	25,000	0,984	A	F 19044
		100,000	3,937	31,000	1,220	31,000	1,220	E	F 19063
		100,000	3,937	36,000	1,417	36,000	1,417	D	F 19001
49,930	1,966	80,000	3,150	15,000	0,591	15,000	0,591	E	F 19030
50,000	1,969	90,000	3,543	23,000	0,906	23,000	0,906	E	F 19026
		100,000	3,937	25,000	0,984	25,000	0,984	B	F 19046
		110,000	4,331	27,000	1,063	32,300	1,272	A	F 19070

Type / Tipo

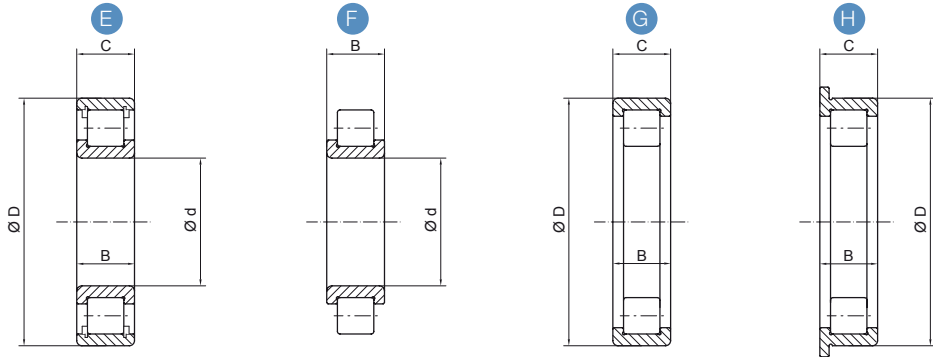

WEIGHT / PESO		FLANGE Ø / Ø VALONA	LOAD / CARGA		SPEED / VELOCIDAD		REMARK / NOTA	REFERENCES / REFERENCIAS
kg	lb		DYNAMIC / DINÁMICA	STATIC / ESTÁTICA	OIL / ACEITE	GREASE / GRASA		
		C	Co	na	ng			
		kN	kN	rpm	rpm			
0,13	0,28	---	33,3	25,9	16000	13000	Special Type NJ	F 19055
0,07	0,16	---	38,3	40,4	10000	8000	Full Complement without Outer Ring	F 19032
0,19	0,41	---	44,0	48,0	13000	10000	Full Complement + Snap Ring in Ø D	F 19023
0,20	0,43	---	50,6	48,0	13000	10000	Special Type NUP	F 19004
0,14	0,31	---	47,4	42,0	13000	10000	Special Type NJ	F 19029
0,13	0,28	---	50,4	47,8	13000	10000	Special without Outer Ring	F 19017
0,33	0,72	---	90,0	85,4	10000	8000	Special without Outer Ring	F 19019
0,17	0,36	---	32,3	29,0	11000	9000	Special Inner Ring	F 19024
0,28	0,61	---	60,9	58,7	7000	6000	Full Complement + Internal Snap Ring	F 19031
0,30	0,66	---	75,5	77,7	7000	6000	Full Complement + Internal Snap ring	F 19045
0,28	0,62	---	67,3	62,0	7000	6000	Full Complement + Internal Snap ring	F 19025
0,58	1,27	NO	85,6	80,8	5500	4600	Full Complement + Internal Snap Ring	F 19078
0,30	0,66	NO	90,0	85,4	11100	9300	Special Without Outer Ring	F 19075
0,53	1,17	---	79,9	72,1	9000	7000	Groove in Ø D	F 19043
0,37	0,81	---	103,8	93,7	9000	7000	Special without Outer Ring	F 19037
0,20	0,43	---	55,2	53,9	10000	8000	Special Type NU	F 19066
0,39	0,86	---	79,0	74,6	6000	5000	Full Complement + Internal Snap Ring	F 19035
0,53	1,17	---	95,0	81,4	6000	5000	Full Complement	F 19020
0,53	1,17	NO	85,6	80,8	5300	4400	Full Complement + Internal Snap Ring	F 19077
0,57	1,25	---	84,5	77,5	9000	7000	Groove in Ø D	F 19012
0,17	0,37	---	68,4	76,0	7000	6000	Full Complement without Outer Ring	F 19048
0,62	1,36	---	111,9	98,5	8000	6000	Internal Snap Ring + Groove in Ø D	F 19067
0,75	1,65	---	108,7	94,0	5000	4000	Full Complement + Snap Ring in Ø D	F 19014
1,17	2,56	NO	169,8	156,0	4600	3800	Full Complement + Snap Ring in Ø D	F 19076
0,49	1,08	---	130,5	129,2	8000	6000	Special without Outer Ring	F 19065
0,70	1,54	---	124,2	104,0	5000	4000	Full Complement + Snap Ring in Ø D	F 19006
0,73	1,61	---	106,0	97,3	8000	6000	Internal Snap Ring	F 19034
0,80	1,76	---	143,8	136,5	5000	4000	Full Complement + Special Inner Ring	F 19013
0,77	1,68	---	124,3	110,2	8000	6000	Internal Snap Ring	F 19033
0,98	2,15	---	136,3	141,0	7000	6000	Groove in Ø D and Ø d	F 19015
0,95	2,09	---	161,0	170,0	5000	4000	Full Complement + Snap Ring in Ø D	F 19002
0,95	2,09	---	131,9	114,7	5000	4000	Full Complement + Snap Ring in Ø D	F 19003
0,87	1,90	---	110,2	94,1	7000	6000	Groove in Ø D	F 19044
1,19	2,62	---	143,5	151,5	5000	4000	Full Complement + Internal Snap Ring	F 19063
1,33	2,93	---	161,0	170,0	5000	4000	Full Complement + Snap Ring in Ø D	F 19001
0,27	0,59	---	51,7	55,2	5000	4000	Full Complement + Internal Snap ring	F 19030
0,62	1,36	---	100,2	108,7	5000	4000	Full Complement + Internal Snap ring	F 19026
0,97	2,13	106,000	112,4	113,4	7000	6000	Outer Ring Flanged	F 19046
1,29	2,84	NO	131,6	116,5	6300	5200	Snap ring in Ø D	F 19070



07.2

SPECIAL CYLINDRICAL BEARINGS RODAMIENTOS CILÍNDRICOS ESPECIALES

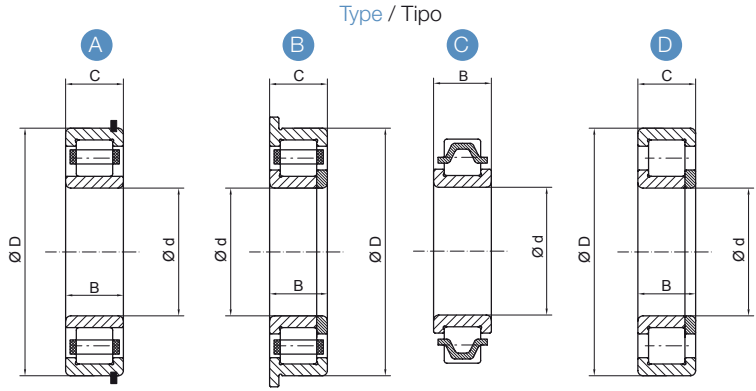

DIMENSIONS / DIMENSIONES								TYPE / TIPO	REFERENCES / REFERENCIAS
d		D		B		C			
mm	inch	mm	inch	mm	inch	mm	inch		
60,000	2,362	110,000	4,331	27,000	1,063	32,300	1,272	A	F 19071
		110,000	4,331	22,000	0,866	22,000	0,866	B	F 19011
		110,000	4,331	28,000	1,102	28,000	1,102	A	F 19042
63,000	2,480	116,000	4,567	28,000	1,102	28,000	1,102	B	F 19047
		130,000	5,118	31,000	1,220	31,000	1,220	B	F 19009
		---	---	34,750	1,368	---	---	C	F 19016
65,000	2,559	---	---	37,500	1,476	---	---	C	F 19038
		140,000	5,512	33,000	1,299	33,000	1,299	B	F 19064
		140,000	5,512	33,350	1,313	33,350	1,313	B	F 19010
67,000	2,638	---	---	32,000	1,260	---	---	C	F 19061
		---	---	38,000	1,496	---	---	C	F 19062
80,000	3,150	140,000	5,512	33,500	1,319	33,500	1,319	B	F 19039
		150,000	5,906	28,000	1,102	27,500	1,083	B	F 19008
84,980	3,346	150,000	5,906	28,000	1,102	27,500	1,083	B	F 19022
---	---	54,600	2,150	---	---	22,000	0,866	G	F 19005
---	---	55,000	2,165	---	---	20,000	0,787	G	F 19079
---	---	62,000	2,441	---	---	16,000	0,630	G	F 19068
---	---	80,000	3,150	---	---	26,500	1,043	G	F 19069

Type / Tipo

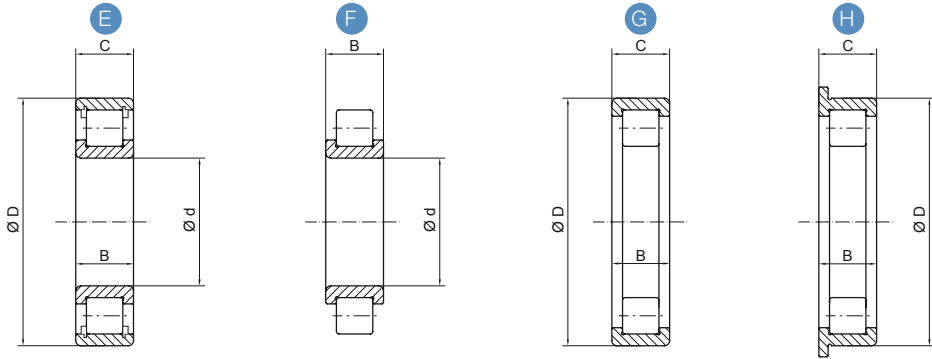

WEIGHT / PESO		FLANGE Ø / Ø VALONA	LOAD / CARGA		SPEED / VELOCIDAD		REMARK / NOTA	REFERENCES / REFERENCIAS
kg	lb		DYNAMIC / DINÁMICA	STATIC / ESTÁTICA	OIL / ACEITE	GREASE / GRASA		
		C	Co	na	ng			
		kN	kN	rpm	rpm			
1,38	3,03	NO	131,6	116,5	6300	5200	Snap ring in Ø D	F 19071
0,87	1,91	116,000	114,4	108,0	6000	5000	Outer Ring Flanged	F 19011
1,12	2,46	---	150,9	154,0	6000	5000	Snap ring in Ø D	F 19042
1,31	2,88	---	143,8	144,4	6000	5000	Special Outer Ring in Type NUP	F 19047
2,16	4,75	136,850	179,4	162,5	5000	4000	Outer Ring Flanged	F 19009
0,73	1,61	---	127,5	137,2	6000	5000	Special without Outer Ring	F 19016
0,77	1,68	---	127,5	137,2	6000	5000	Special without Outer Ring	F 19038
2,43	5,35	146,000	187,0	196,6	5000	4000	Outer Ring Flanged	F 19064
2,48	5,46	147,750	215,1	197,0	5000	4000	Outer Ring Flanged	F 19010
0,71	1,55	---	139,4	149,8	5000	4000	Special Without Outer Ring	F 19061
0,75	1,66	---	139,4	149,8	5000	4000	Special Without Outer Ring	F 19062
2,34	5,15	147,000	217,6	243,0	5000	4000	Outer Ring Flanged	F 19039
2,23	4,90	157,022	197,8	202,0	4000	3000	Outer Ring Flanged	F 19008
2,08	4,58	157,022	198,0	202,0	4000	3000	Outer Ring Flanged	F 19022
0,21	0,45	---	74,2	66,0	8000	6000	Full Complement + No inner ring + Snap ring in Ø D	F 19005
0,20	0,43	NO	63,0	58,8	7000	5900	Full Complement + No inner ring + Snap ring in Ø D	F 19079
0,18	0,39	---	46,1	40,7	11000	9000	Special without Inner Ring	F 19068
0,45	0,98	---	109,6	97,9	8000	6000	Special without Inner Ring	F 19069



08

Commercial vehicle bearings

Rodamientos para vehículo industrial

08.0	Technical introduction / Introducción técnica	262
08.1	Hub wheel truck / Hub de rueda de camión	264
08.2	Kit wheel truck / Kit de rueda de camión	272
08.3	Compact wheel truck / Buje compacto de camión	274

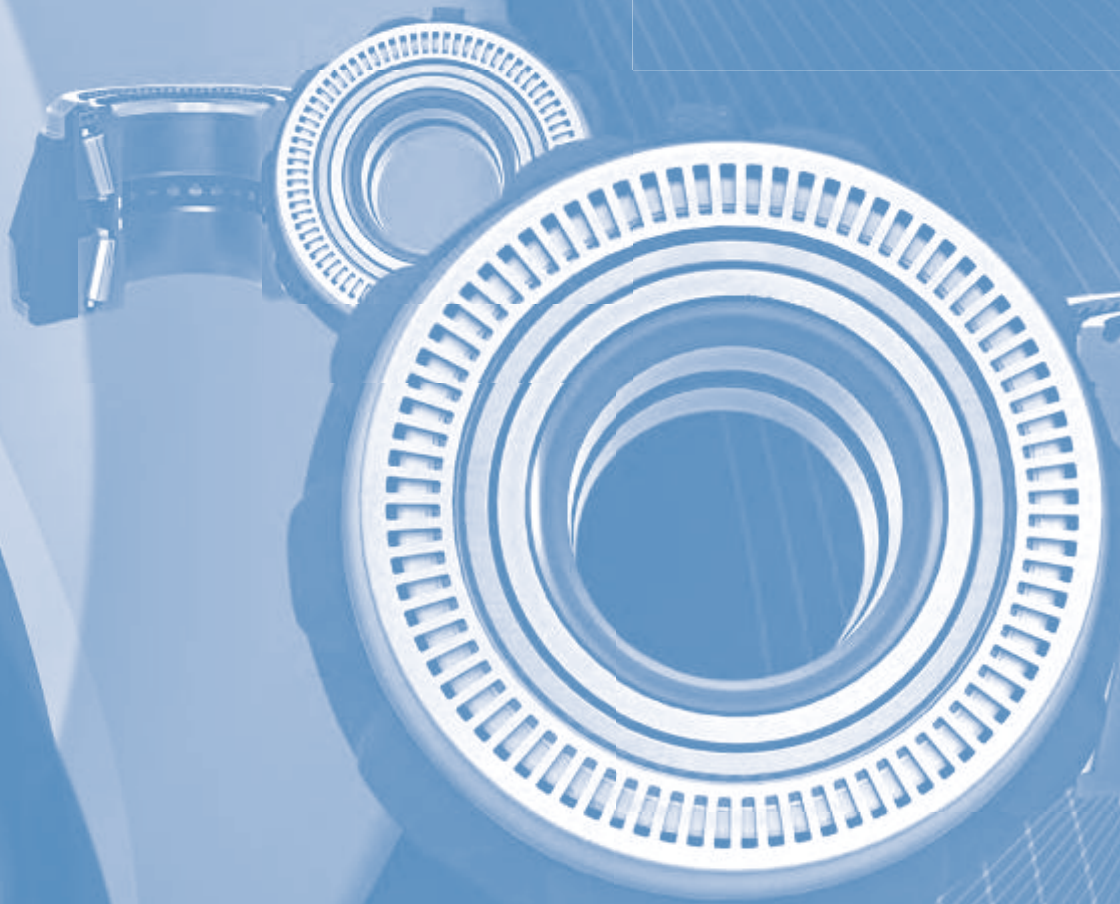

Technical Introduction / Introducción Técnica

Description

Hub Units for industrial vehicles are compact bearings that support high radial and axial loads in both directions. This bearing arrangement provides systems that are rigid or require a robust axial guidance.

Advantages

- Universal Applications.
- High radial and axial load capacity in both directions.
- Space saving construction.
- Life lubrication.

Hub Units, as well as other Fersa Bearings products, are designed to support extreme working conditions and are used by the main global level industrial vehicle manufacturers.

Design

Hub Units for industrial vehicles are composed of inner and outer rings, plastic rollers and cages.

They correspond to a pair of single row tapered bearings in arrangement "O" but occupy less space.

The hub unit bearings for industrial vehicles manufactured in Fersa Bearings are designed with one objective: to obtain maximum efficiency. This, together with an exhaustive quality control in the manufacturing processes, ensures maximum durability for maintenance free bearings.

Fersa's bearings are assembled in our specialized technical center in Zaragoza, Spain, guaranteed with the latest technological advances in R+D and quality, where 100% of our production is verified.

All our bearings are subject to exhaustive trial and testing in the CBE (Center for Bearing Excellence), our specialized testing center, before being released, guaranteeing our high technical and quality standards.

Descripción

Las unidades de buje para vehículos industriales son rodamientos compactos que pueden soportar altas cargas radiales y axiales en ambos sentidos. Esta disposición de rodamientos permite crear sistemas rígidos o que requieran una guía axial robusta.

Ventajas:

- Aplicaciones universales.
- Alta capacidad de carga radial y axial en ambos sentidos.
- Construcción para ahorrar espacio.
- Lubricados de por vida.

Las unidades de buje, así como otros rodamientos de Fersa Bearings, están diseñadas para soportar condiciones extremas de trabajo, siendo los rodamientos utilizados por principales fabricantes del mercado de vehículos industriales a nivel global.

Diseño

Las unidades de buje para vehículos industriales son unidades con aros interiores y exteriores robustos, rodillos y jaulas de plástico.

Corresponden a un par de rodamientos de rodillos cónicos de una hilera en disposición "O", pero ocupan menos espacio.

Los rodamientos de unidades de buje para vehículos industriales fabricados en Fersa Bearings son diseñados con un objetivo: conseguir la máxima eficiencia. Esto, acompañado de un exhaustivo control de calidad en los procesos de fabricación asegura la máxima durabilidad del rodamiento libre de mantenimiento.

Los rodamientos son montados en nuestro centro técnico especializado en Zaragoza, garantizado con los más recientes avances tecnológicos en el área de I+D y calidad, donde se verifica el 100% de la producción.

Nuestro centro especializado de ensayos del CBE (Center for Bearing Excellence) somete a los rodamientos a un exhaustivo programa de ensayos y pruebas antes de liberar el producto, garantizando nuestros altos estándares técnicos y de calidad.

Hub Wheel Truck



Fersa Hub Wheel Truck (HWT) bearings are pre-adjusted sets composed of two inner sets lodged in one outer ring.

Fersa Bearings guarantees optimal bearing performance with high loads thanks to their precise axial clearance, maintenance free compact design and use of high quality grease.

Our HWT bearings are quick and easy to assemble on vehicle wheel hubs.

Reduction in components means reduction assembly time.

Reduction of the required space for bearings and, consequently, less weight.

Prefixed by the manufacturer and, therefore, easy to assemble.

Life lubricated, minimum maintenance required.

Less handling required, therefore lower risk of contamination.

Los rodamientos Fersa Hub Wheel Truck (HWT) son conjuntos preajustados, compuestos de dos conjuntos interiores alojados en un solo aro exterior.

Debido a su precisa holgura axial, su diseño compacto y libre de mantenimiento y el uso de grasas de alta calidad, Fersa Bearings garantiza un óptimo funcionamiento del rodamiento a cargas elevadas.

Con nuestros rodamientos HWT se asegura el montaje rápido y sencillo en los cubos de rueda de los vehículos.

Ventajas

Reducción del número de componentes, lo cual implica un ahorro de tiempo en el montaje.

Disminución del espacio requerido para el rodamiento, y como consecuencia, del peso.

Sencillez del montaje, dado que el reglaje está ya fijado desde fábrica.

Mínimo mantenimiento, al estar engrasado de por vida.

Menor riesgo de contaminación, al reducir las manipulaciones.



Kit Wheel Truck

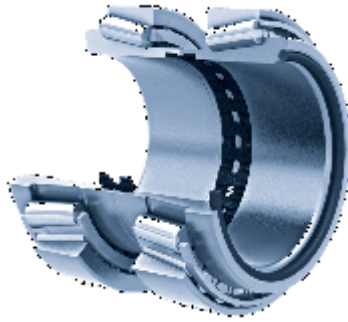

Fersa's Kit Wheel Truck (KWT) are pre-adjusted high precision bearings, optimal for all kinds of applications in industrial vehicles.

KWT bearings are pre-greased with the highest quality grease, guaranteeing their performance in the most extreme conditions.

Pre-adjusted by manufacturer and easy to assemble.

Life lubricated, low maintenance.

Less handling required, reduces risk of impurities entering.

Advantages

1. Lubricated compact unit.
2. Life-greased.
3. Easy to assemble.
4. Two-step assembly procedure per unit.
5. Supplied with bearings and seal assembly tools.

Los rodamientos Fersa Kit Wheel Truck (KWT) son conjuntos de rodamientos de alta precisión, preajustados, cuyo funcionamiento es óptimo para todo tipo de aplicaciones en vehículo industrial.

Los KWT son unidades previamente engrasadas con grasa de alta calidad que garantizan su uso en las condiciones más exigentes.

Sencillez del montaje, dado que el reglaje está ya fijado desde fábrica.

Mínimo mantenimiento, al venir engrasado de por vida.

Menor riesgo de impurezas, al reducir las manipulaciones.

Ventajas

1. Unidad compacta lubricada.
2. Ya engrasada de por vida.
3. Simple proceso de montaje.
4. Dos pasos de montaje por cada unidad.
5. Suministrado con herramienta de montaje para los rodamientos y retenes.

Compact Wheel Truck



Fersa's Compact Wheel Truck (CWT) bearings are compact and integrated in the wheel hub.

Our CWT's units are composed of two life-lubricated bearings, perfectly aligned and pre-adjusted in compliance with the highest market demands. We use the highest quality grease to ensure excellent performance in the most adverse conditions.

Application assembly of CWT bearings is practical and simple.

Advantages

Easy assembly, substituting one set for another.

Reduction of the required space for bearings and, consequently, less weight.

Prefixed by the manufacturer and, therefore, easy to assemble.

Life lubricated, minimum maintenance required.

Less handling required, therefore lower risk of contamination.

Los rodamientos Fersa Compact Wheel Truck (CWT) son rodamientos compactos e integrados en el cubo de la rueda del vehículo.

Nuestros CWT, son unidades formadas por dos rodamientos perfectamente alineados, lubricados de por vida y preajustados para cumplir las más altas exigencias del mercado. Usamos grasa de alta calidad para asegurar su funcionamiento con las condiciones más adversas. Asegurando así mismo un montaje en la aplicación simple y práctico.

Ventajas

Montaje sencillo, sustitución de un conjunto por otro.

Reducción del espacio requerido para el rodamiento, y como consecuencia, del peso.

Sencillez de ajuste, dado que el reglaje está ya fijado desde fábrica.

Mínimo mantenimiento, al venir engrasado de por vida.

Menor riesgo de contaminación, al reducir las manipulaciones.



Bearing Characteristics / Características de los rodamientos

Tolerances

Hub Units for industrial vehicles can also be manufactured with special tolerances, according to the specific application.

Misalignment

Inaccuracies in the alignment of bearing locations must be taken into account. Misalignment occurs when cage calibers are not machined in one set.

Angular misalignment of the shafts of the inner and outer ring is caused by larger shaft deflections and cage deformation.

Bearings for industrial vehicle Hub Units have low misalignment capacity. The roller and contact surface cross shape implies that the tension material in the rolling contact areas is maintained so uniform that, with the correct alignment angle, the useful life of the bearing is not affected.

All other misalignment will result in increased noise when functioning.

Internal Clearance

Internal clearance is the distance that a bearing ring can be displaced in relation to the other ring, either axially or radially, from one end to the other.

The internal clearance of Hub Units is pre-adjusted by the manufacturer. The effects are:

- No internal clearance produced from elastic deformation when applying load on the bearing.
- No shaft offset and rotation precision increases.
- Prevents fretting produced in the tracks because of external vibrations.

Internal clearance reduction is vital to the life of a bearing and it is a matter of analysis in each stage of the assembly, as shown in the graphic below.

Tolerancias

Las unidades de buje para vehículos industriales también se pueden fabricar con tolerancias especiales, de acuerdo con la aplicación específica.

Desalinamiento

Las imprecisiones de alineación de la posición del rodamiento deben tenerse en cuenta. La desalineación ocurre cuando los calibres de las jaulas no están mecanizados en un conjunto.

La desalineación angular de los ejes del aro interior y exterior se debe a desviaciones de ejes mayores y a las deformaciones de las cajas.

Los rodamientos para unidades de buje para vehículos industriales tienen una capacidad de desalineación pequeña. La forma en cruz de los rodillos y de las pistas de rodadura implica que el material tensor en las áreas de rotación de contacto se mantiene tan uniforme, que con el ángulo de alineación indicado, la vida útil del rodamiento no se verá afectada.

Cualquier otra desalineación del rodamiento resultará en un aumento del ruido durante su funcionamiento.

Juego Interno

El juego del rodamiento es la distancia a través de la cual un aro del rodamiento puede desplazarse en relación al otro aro en el sentido axial o radial desde la posición en un extremo al otro.

Las unidades de bujes vienen ajustadas de fábrica con un juego interno. Los efectos son:

- No se produce juego interno por deformaciones elásticas cuando se aplica carga sobre el rodamiento.
- Se evita el descentramiento del eje y la precisión de rotación es mayor.
- Se previene el fretting producido en la pista de rodadura por vibraciones externas.

La reducción del juego interno es crítica para la vida del rodamiento y se estudia en cada una de las etapas de montaje, como se muestra en el siguiente gráfico.

The extended inner rings design bypasses the need for shims.

- Reduced width tolerance.
- Pre-adjusted distance between ring faces to ensure optimal preload application after applying torque setting.
- Control of axial clearance in CWT and HWT family bearings.

Diseño de aros interiores extendidos que evitan el uso de espaciadores.

- Reducidas tolerancias de altura.
- Distancia pre-ajustada entre caras de aros para asegurar óptima precarga de aplicación tras aplicar par de apriete.
- Control de la holgura axial para los rodamientos de las familias CWT y HWT

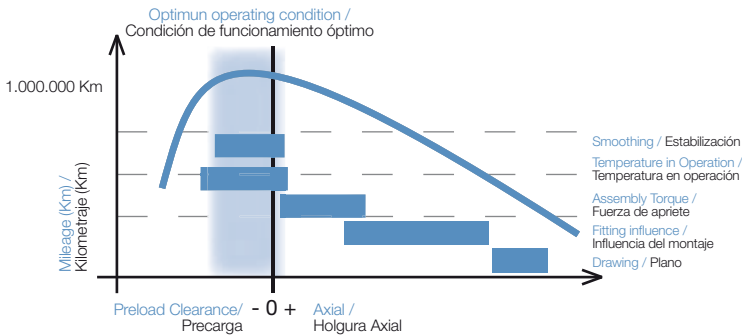

Speed

The maximum operative speed of Hub Units can be limited under several criteria. Most frequently the decisive element of criteria is the functional temperature that rises with speed. Other speed criteria can be the unknown quantity of rotation and slip lubrication due to strong centrifugal forces or important kinematic viscosity rotation changes of rolling elements.

Velocidad

La velocidad máxima operativa de las unidades de buje se puede ver limitada por varios criterios. Por regla general el criterio decisivo es la temperatura funcional, que aumenta con la velocidad. Otros criterios de velocidad pueden ser una cantidad de lubricante de rotación y de deslizamiento incierta debido a importantes fuerzas centrífugas o cambios importantes de rotación de viscosidad cinemática de los elementos de rotación.

Load Capacity

Hub Units are designed for supporting heavy loads at high speeds. Tapered roller bearings have a high capacity for supporting both radial and axial loads, allowing a misalignment of 0.06°.

Capacidades de Carga

Están diseñados para altas cargas a altas velocidades. Los rodamientos de rodillos cónicos, tienen una gran capacidad para resistir tanto cargas radiales como axiales, admitiendo des-alineamientos de 0.06°.

Equivalent dynamic load of (ISO 281): The axial balance of the shaft depends of not only the applied forces but of the forces induced by the radial loads applied to each bearing.

Capacidad de carga dinámica equivalente (ISO 281): El equilibrio axial del eje depende no sólo de las fuerzas aplicadas, sino también de las fuerzas inducidas por las cargas radiales aplicadas en cada rodamiento.

$$P = Fr + 1.1 Y * Fa \text{ si } Fa / Fr \leq e$$

$$P = Fr + 1.1 Y * Fa \text{ si } Fa / Fr \leq e$$

$$P = 0.67 Fr + 1.68 Y * Fa \text{ si } Fa / Fr > e$$

$$P = 0.67 Fr + 1.68 Y * Fa \text{ si } Fa / Fr > e$$

Equivalent static load: the P0 value is the greater value of the two values obtained when applying the following formula:

Capacidad de carga estática equivalente: Su valor P0 es el mayor de los dos valores obtenidos aplicando la siguiente fórmula:

$$P0 = Fr + Y0 * Fa$$

$$P0 = Fr + Y0 * Fa$$

Lubrication

Grease functions as a lubrication film between the rollers and the raceway to prevent direct metal contact.

Fersa manufactures pre-greased Hub Units, using the highest quality grease, to ensure the correct distribution and quantity of in all rollers.

Sealing

Fersa's bearings have three different types of contamination prevention sealing:

- Seals between outer and inner ring to prevent grease loss and contamination (oil, water, impurities ...).
- O-rings are placed in the inner taper (vehicle side) to prevent external impurities entering through the stub shaft.
- Axial clamp seal between inner rings in traction applications against shaft oil bath.

Lubricación

La función de la grasa es crear una película lubricante entre los rodillos y la superficie de rodadura para prevenir el contacto directo entre metales.

En Fersa hacemos las unidades de bujes pre-engrasadas de fábrica con grasa de alta calidad. Así aseguramos que contienen la cantidad correcta y una distribución uniforme entre todos los rodillos.

Estanqueidad

Los rodamientos Fersa tienen tres tipos diferentes de sellado para evitar la contaminación:

- Para evitar pérdida de grasa así como entrada de contaminación (aceite, agua, impurezas...) se colocan retenes entre el aro exterior y el aro interior
- Para impedir la entrada de impurezas a través de la mangueta se coloca una junta tórica en el cono interior (lado vehículo).
- Para hacer el rodamiento estanco frente al baño de aceite del eje se coloca una junta axial entre los aros interiores en las aplicaciones traccionadas.



08.1

HUB WHEEL TRUCK HUB DE RUEDA DE CAMIÓN

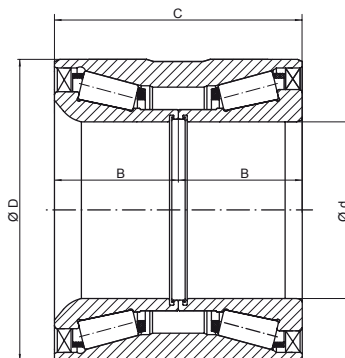
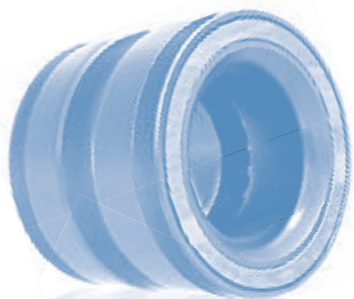

DIMENSIONS / DIMENSIONES								REFERENCES / REFERENCIAS
d		D		B		C		
mm	inch	mm	inch	mm	inch	mm	inch	
55,000	2,165	90,000	3,543	30,000	1,181	60,000	2,362	F 15121
60,000	2,362	108,000	4,252	37,500	1,476	75,000	2,953	F 15120
68,000 / 68,200	2,6772 / 2,6850	127,000 / 132,000	5,0000 / 5,1969	57,500	2,264	115,000	4,528	F 15097
78,000	3,071	130,000	5,118	45,000	1,772	90,000	3,543	F 15125
78,000	3,071	130,000	5,118	45,000	1,772	90,000	3,543	F 15127
82,000	3,228	140,000	5,512	55,000	2,165	110,000	4,331	F 15126
82,000	3,228	140,000	5,512	57,500	2,264	115,000	4,528	F 15100
90,000	3,543	160,000	6,299	62,500	2,461	125,000	4,921	F 15122

WEIGHT / PESO		LOAD / CARGA		LOAD FACTORS / FACTORES DE CARGA						REFERENCES / REFERENCIAS
		DYNAMIC / DINÁMICA	STATIC / ESTÁTICA	DYNAMIC / DINÁMICA					STATIC / ESTÁTICA	
kg	lb	C	Co	e	Xk	Y1	X	Y2	Yo	
1,40	3,080	154,4	263,8	0,41	1,00	1,66	0,67	2,47	1,62	F 15121
2,83	6,226	238,2	384,4	0,40	1,00	1,66	0,67	2,48	1,63	F 15120
6,50	14,300	296,4	532,6	0,50	1,00	1,36	0,67	2,02	1,34	F 15097
4,36	9,592	259,5	472,4	0,42	1,00	1,59	0,67	2,37	1,56	F 15125
4,35	9,559	259,5	472,4	0,42	1,00	1,59	0,67	2,37	1,56	F 15127
6,60	14,509	409,2	769,0	0,36	1,00	1,87	0,67	2,79	1,83	F 15126
6,45	14,190	347,2	620,8	0,40	1,00	1,67	0,67	2,48	1,64	F 15100
10,24	22,528	467,0	855,6	0,40	1,00	1,70	0,67	2,53	1,66	F 15122



08.2

KIT WHEEL TRUCK KIT DE RUEDA DE CAMIÓN

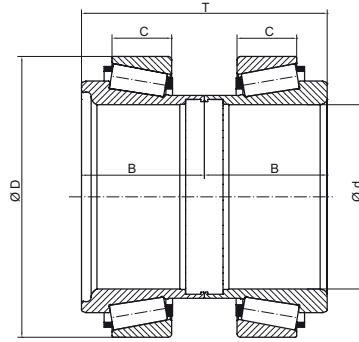
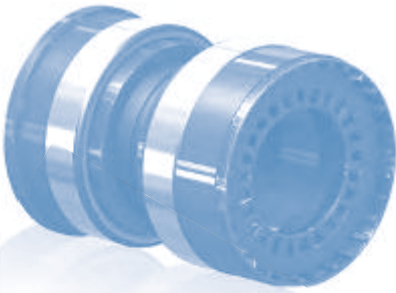

DIMENSIONS / DIMENSIONES										REFERENCES / REFERENCIAS
d		D		T		B		C		
mm	inch	mm	inch	mm	inch	mm	inch	mm	inch	
68,000 / 68,200	2,677 / 2,685	125,000	4,921	115,000	4,528	61,000 / 54,000	2,402 / 2,126	32,000	1,260	F 200001
68,000 / 68,200	2,677 / 2,685	125,000	4,921	115,000	4,528	61,000 / 54,000	2,402 / 2,126	47,550 / 40,550	1,872 / 1,596	F 200013
93,800 / 94,000	3,692 / 3,700	148,000	5,827	135,000	5,315	67,500	2,657	29,600	1,165	F 200002
93,800 / 94,000	3,692 / 3,700	148,000	5,827	135,000	5,315	67,500	2,657	43,000	1,693	F 200014
105,000	4,134	160,000	6,299	140,000	5,512	70,000	2,756	34,000	1,339	F 200004
110,000	4,331	170,000	6,693	146,000	5,748	76,000 / 70,000	2,992 / 2,755	37,000	1,457	F 200005

WEIGHT / PESO		LOAD / CARGA		LOAD FACTORS / FACTORES DE CARGA						REFERENCES / REFERENCIAS
		DYNAMIC / DINÁMICA	STATIC / ESTÁTICA	DYNAMIC / DINÁMICA					STATIC / ESTÁTICA	
		C	Co	e	Xk	Y1	X	Y2	Yo	
kg	lb	kN	kN							
4,90	10,78	372,6	622,4	0,41	1,00	1,65	0,67	2,45	1,62	F 200001
4,80	10,56	372,6	622,4	0,41	1,00	1,65	0,67	2,45	1,62	F 200013
6,00	13,2	424,2	762,2	0,37	1,00	1,81	0,67	2,70	1,78	F 200002
5,91	13,002	424,2	762,2	0,37	1,00	1,81	0,67	2,70	1,78	F 200014
6,86	15,081	474,0	948,0	0,28	1,00	2,38	0,67	3,55	2,33	F 200004
8,53	18,766	548,4	1130,0	0,29	1,00	2,35	0,67	3,50	2,30	F 200005

08.3

COMPACT WHEEL TRUCK BUJE COMPACTO DE CAMIÓN

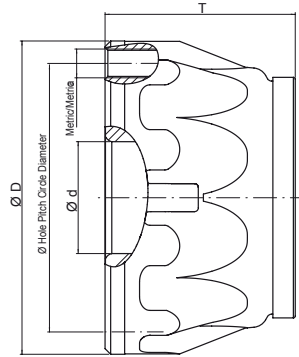

DIMENSIONS / DIMENSIONES										REFERENCES / REFERENCIAS
d		D		T		HOLE PITCH DIAMETER / DIÁMETRO DE POSICIÓN DE LOS AGUJEROS		HOLE NUMBER / NÚMERO DE AGUJEROS	METRIC / METRICA	
mm	inch	mm	inch	mm	inch	mm	inch			
45,000	1,772	120,000	4,724	84,900	3,343	100,000	3,937	6	M12 X 1,25	F 300006
60,000	2,362	168,000	6,614	102,000	4,016	144,000	5,669	10	M14 X 1,5	F 300007
70,000	2,756	196,000	7,717	140,000	5,512	168,000	6,614	12	M18 X 1,5	F 300005
82,000	3,228	196,000	7,717	113,000	4,449	168,000	6,614	12	M18 X 1,5	F 300001

WEIGHT / PESO		LOAD / CARGA		LOAD FACTORS / FACTORES DE CARGA						REFERENCES / REFERENCIAS
		DYNAMIC / DINÁMICA	STATIC / ESTÁTICA	DYNAMIC / DINÁMICA					STATIC / ESTÁTICA	
		C	Co	e	Xk	Y1	X	Y2	Yo	
kg	lb	kN	kN							
4,06	8,932	201,2	311,4	0,38	1	1,75	0,67	2,61	1,72	F 300006
9,3	20,46	312,7	517,8	0,4	1	1,67	0,67	2,48	1,64	F 300007
13,16	28,952									F 300005
15,3	33,66	405,2	770,6	0,42	1	1,61	0,67	2,41	1,58	F 300001





A series of horizontal dotted lines for writing, starting from the top of the page and extending to the bottom.

Experts in Bearing Solutions



Fersa Bearings, S.A.

Calle Bari, 18 - PLAZA
50197 Zaragoza - Spain
T_ +34 976 333 850

fersa@fersa.com
www.fersa.com

