

SKF Maintenance and Lubrication Products

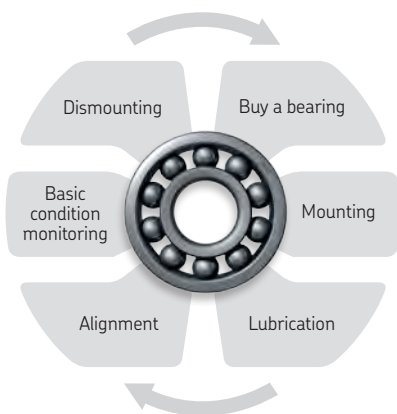

Extending the Bearing Life Cycle

Mounting & dismounting

Mechanical tools	10
Heating tools	38
Hydraulic tools	48

Instruments

Alignment	74
Basic condition monitoring	90

Lubrication

Lubricants	120
Storage tools	156
Transfer tools	158
Manual grease dispensing tools	159
Automatic grease dispensing tools	164
Oil dispensing & inspection	175
Lubrication analysis tools	178
Lubrication software	180

The SKF Bearing Life Cycle

Help your bearing achieve its maximum service life

Every bearing has a certain service life potential. However, research has shown that, for various reasons, not every bearing achieves it. Important stages which have a major impact on a bearing service life can be recognised during the bearing's lifecycle. These stages are mounting, lubrication, alignment, basic condition monitoring and dismantling.

The stages in a bearing life cycle are extremely important for achieving the maximum service life of the bearing. By applying the right maintenance practices and using the correct tools, you can considerably extend your bearing's service life and increase plant productivity and efficiency.

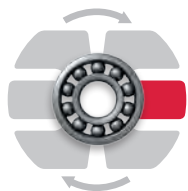

Mounting

Includes mechanical fitting tools, induction heaters and hydraulic equipment

Mounting is one of the critical stages of the bearing's lifecycle. If the bearing is not mounted properly using the correct method and tools, the bearing's service lifetime will be reduced. Individual applications may require mechanical, heat or hydraulic mounting methods for correct and efficient bearing mounting. Selecting the correct mounting technique for your application will help you extend your bearing's service life and reduce costs resulting from premature bearing failure, as well as potential damage to the application.



Lubrication

Includes bearing greases, manual and automatic lubricators and lubrication accessories

Correct bearing lubrication is an essential step in reaching the bearing's service lifetime. It is important to select grease suitable for the bearing's application, and to apply the correct quantity before commissioning the bearing. During operation, the bearing will require periodic relubrication. The right quantity of the right grease applied at the right intervals is essential to achieving optimum bearing performance and maximum service life. Using manual relubrication methods is common practice; however, continuous relubrication offers many advantages. Continuous relubrication can be performed by using automatic lubricators, which provide a more consistent, correct and contamination-free grease supply.



Alignment

Includes shaft and belt alignment tools and machinery shims

After the bearing has been mounted in an application such as a motor connected to a pump, the application should be aligned. If the application is not properly aligned, the misalignment can cause the bearing to suffer additional load, friction and vibration. These can accelerate fatigue and reduce the bearing's, as well as other machine components, service life. Furthermore, increased vibration and friction can significantly increase energy consumption and the risk of premature failures.

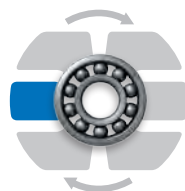

Basic condition monitoring

Includes temperature, sound, visual inspection, speed, electrical discharge and vibration measuring instruments

During operation, it is important to regularly inspect the condition of the bearing by performing basic condition monitoring measurements. These regular inspections will allow the detection of potential problems and help to prevent unexpected machine stops. Consequently, the machine maintenance can be planned to suit the production schedule, increasing the plant's productivity and efficiency.

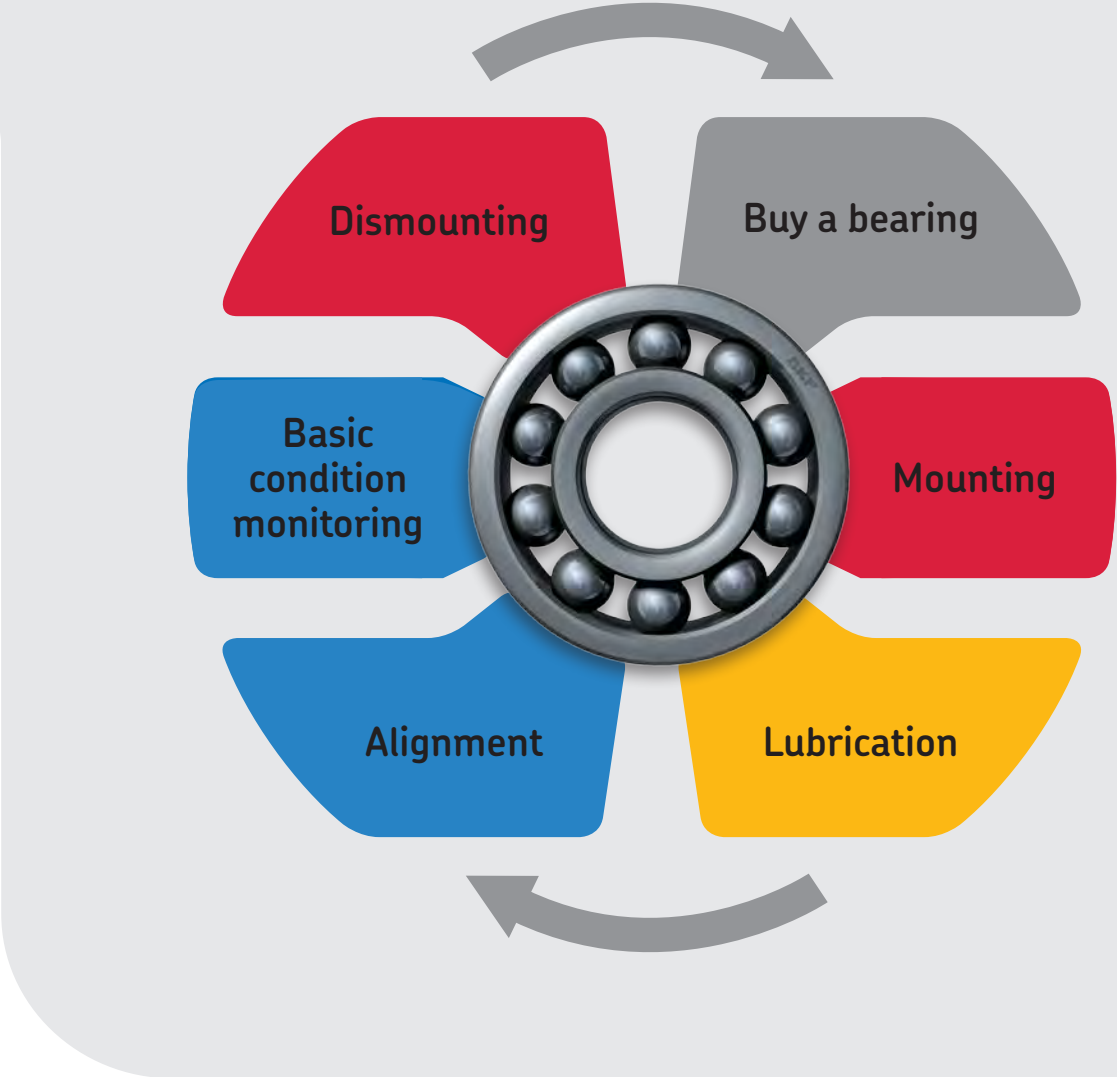

Dismounting

Includes pullers, both mechanical and hydraulic, induction heaters and hydraulic equipment

At some point, the bearing will reach the end of its service life and will have to be replaced. Although the bearing may not be used again, it is extremely important to dismount it correctly so that the service life of the replacement bearing is not compromised. Firstly, the use of proper dismounting methods tools will help prevent damage to other machine components, such as the shaft and housing, which are often re-used. Secondly, incorrect dismounting techniques can be hazardous to maintenance personnel.

Inside this catalogue, you will find SKF's complete range of maintenance products which can help you get the maximum service life from your bearings. For more information about SKF maintenance products or to order any of these products, please contact your local SKF authorised distributor or SKF sales company. On the Internet, SKF can be found at www.skf.com. SKF Maintenance Products can be found at www.mapro.skf.com.

Prevent over 60% of premature bearing failures



16%

Poor fitting

Around 16% of all premature bearing failures are caused by poor fitting (usually brute force...) and maintenance personnel being unaware of the availability of the correct fitting tools. Individual installations may require mechanical, hydraulic or heat application methods for correct and efficient mounting or dismounting. SKF offers a complete range of tools and equipment to make these tasks easier, quicker and more cost effective, backed up by a wealth of service engineering know-how. Professional fitting, using specialised tools and techniques, is another positive step towards achieving maximum machine uptime.



36%

Poor lubrication

Although 'sealed-for-life' bearings can be fitted and forgotten, some 36% of premature bearing failures are caused by incorrect specification and inadequate application of the lubricant. Inevitably, any bearing deprived of proper lubrication will fail long before its normal service life. Because bearings are usually the least accessible components of machinery, neglected lubrication frequently compounds the problem. Wherever manual maintenance is not feasible, fully automatic lubrication systems can be specified by SKF for optimum lubrication. Effective lubrication and using only recommended SKF greases, tools and techniques helps to significantly reduce downtime.



14%

Contamination

A bearing is a precision component that will not operate efficiently unless both the bearing and its lubricants are isolated from contamination. And, since sealed-for-life bearings in ready-greased variants account for only a small proportion of all bearings in use, at least 14% of all premature bearing failures are attributed to contamination problems. SKF has an unrivalled bearing manufacturing and design capability and can tailor sealing solutions for the most arduous operating environments.



34%

Fatigue

Whenever machines are overloaded, incorrectly serviced or neglected, bearings suffer from the consequences, resulting in 34% of all premature bearing failures. Sudden or unexpected failure can be avoided, since neglected or overstressed bearings emit 'early warning' signals which can be detected and interpreted using SKF condition monitoring equipment. The SKF range includes hand-held instruments, hard-wired systems and data management software for periodic or continuous monitoring of key operating parameters.

SKF methods and tools

Bearing arrangements

Mounting tools

Dismounting tools

Mechanical Hydraulic Oil injection Heaters



Mechanical Hydraulic Oil injection Heaters

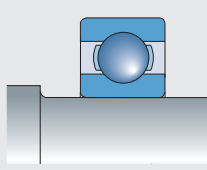



Cylindrical seating



Small bearings
Medium bearings
Large bearings

Cylindrical roller bearing types NU, NJ, NUP, all sizes





			
			
			

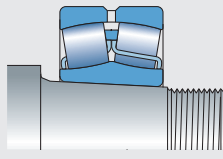

			
			
			

Tapered seating



Small bearings
Medium bearings
Large bearings





			
			
			

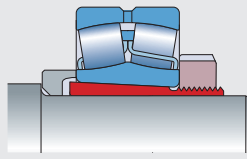

			
			

Adapter sleeve



Small bearings
Medium bearings
Large bearings



			
			
			



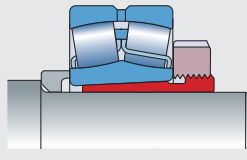

			
			
			

Withdrawal sleeve



Small bearings
Medium bearings
Large bearings

Small bearings: bore diameter <80 mm / Medium bearings: bore diameter 80–200 mm / Large bearings: bore diameter >200 mm / * Only for self-aligning ball bearings.

 Jaw puller page 22

 Bearing separator page 26

 Hydraulic puller page 23

 Fitting tool page 10

 Hook spanner page 13

 Impact spanner page 16

 Hydraulic nut and pump page 52

 Drive-up Method page 50

 Oil Injection Method page 48

 Hot plate induction heater page 40

 Aluminium ring, EAZ heater page 44

Mechanical tools

SKF Bearing Fitting Tool Kit TMFT series	10
SKF Hook Spanners HN series	12
SKF Adjustable Hook Spanners HNA series	13
SKF Hook Spanners HN ../SNL series	14
SKF Axial Lock Nut Sockets TMFS series	15
SKF Impact Spanners TMFN series	16
SKF Bearing Lock Nut Spanner TMHN 7 series	17
SKF Combi Kit TMMK series	18
SKF Mechanical pullers TMA series	20
SKF Hydraulic pullers TMA ..H series	20
SKF Hydraulic puller sets TMA ..H /SET series	21
SKF Standard Jaw Pullers TMMP series	22
SKF Heavy Duty Jaw Pullers TMMP series	22
SKF Heavy Duty Jaw Pullers TMHP series	23
SKF Hydraulic Jaw Puller Kit TMHP 10E	24
SKF Reversible Jaw Puller TMMR F series	25
SKF Strong Back Pullers TMBS E series	26
SKF Hydraulic Puller Kit TMHC 110E	26
SKF Blind Housing Puller Kit TMBP 20E	28
SKF Deep Groove Ball Bearing Puller Kit TMMD 100	29
SKF Internal Bearing Puller Kits TMIP series	31
Accessories	34

Heating tools

SKF Portable induction heater TMBH 1	40
SKF Induction Heater TIH 030m	40
SKF Induction Heater TIH 100m	40
SKF Induction Heater TIH 220m	41
SKF Induction Heater TIH L series	41
SKF Multi-core induction heaters TIH MC series	43
SKF Electric Hot Plate 729659 C	44
SKF Aluminium Heating Rings TMBR series	44
SKF Fixed Induction Heaters EAZ series	45
SKF Adjustable Induction Heaters EAZ series	46
Accessories	47

Hydraulic tools

Accurate axial drive-up of spherical roller and CARB toroidal roller bearings	50
SKF Hydraulic Nut Drive-up Adapter HMVA 42/200	51
SKF Hydraulic Nuts HMV ..E series	52
SKF Hydraulic Pump TMJL 50	58
SKF Hydraulic Pump 729124	58
SKF Hydraulic Pump TMJL 100	59
SKF Hydraulic Pump 728619 E	59
SKF Oil Injector 226400 E series	60
SKF Oil Injection Kits 729101 series	61
SKF Oil Injection Set THKI series	61
SKF Air-driven Hydraulic Pumps and Injectors THAP E series	62
SKF Pressure Gauges	63
Accessories	64

Mounting & dismounting

Mechanical tools	10
Heating tools	38
Hydraulic tools	48

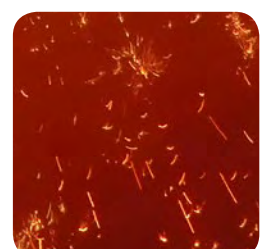
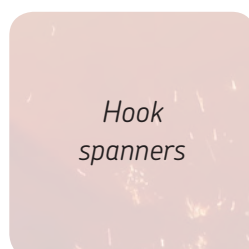
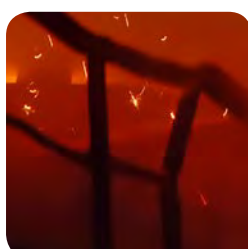
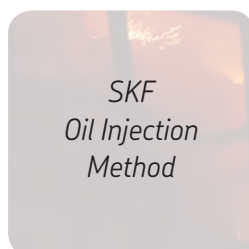

Mounting and dismounting

Mounting

Around 16% of all premature bearing failures are a result of poor fitting or using incorrect mounting techniques. Individual applications may require mechanical, heat or hydraulic mounting methods for correct and efficient bearing mounting. Selecting the correct mounting technique for your application will help you extend your bearing's service life and reduce costs resulting from premature bearing failure, as well as potential damage to the application.



Mounting bearings in a cold condition

Small and medium size bearings are generally cold mounted. Traditionally, the bearing is mounted using a hammer and a length of old pipe. This practice can cause forces to be transmitted through the rolling elements, resulting in damage to the raceways. SKF's fitting tool helps prevent bearing damage by applying the forces to the bearing ring with the interference fit.

Mounting bearings using heat

Oil baths are often used for heating bearings prior to mounting. However, this method can contaminate the bearing, resulting in premature bearing failure. Today, induction heating is the most common technique for heating bearings since it allows a high degree of controllability, efficiency and safety. SKF has set the standards for the development of induction heaters for bearing applications. SKF bearing induction heaters are equipped with many features, which help prevent bearing damage during heating.

Mounting bearings using hydraulic techniques

SKF has pioneered the use of hydraulic techniques, such as the SKF Oil Injection Method and the SKF Drive-up Method, for mounting bearings. These techniques have helped to simplify bearing arrangements and facilitate correct and easy mounting. SKF has also developed a comprehensive range of tools and equipment to put these hydraulic techniques into effect.





Dismounting

When dismounting bearings, care must be taken not to damage other machine components, such as the shaft or housing, as damage can compromise the machine's efficiency and lifetime. Bearings are sometimes dismounted to maintain or replace other components of the machine. These bearings are often re-used. Selecting the correct dismounting methods and tools is then essential in reducing the risk of personal injuries and reducing the risk of damaging the bearing, thus allowing it to be used again. Individual applications may require mechanical, heat or hydraulic dismounting methods and tools to allow safe, correct and efficient bearing dismounting.

Mechanical dismounting

Choosing the right puller for the job is critical. The puller type, and its maximum withdrawal capacity are crucial for completing any dismounting job safely and easily. Puller overload can result in breakage of the puller's arms and/or beam and therefore should be avoided. This breakage can damage the bearing or shaft and can cause personal injury. In general, it is recommended to use a three-arm puller rather than a two-arm puller as the three-arm puller is more stable. Whenever possible, apply the withdrawal force to the ring with the interference fit. SKF offers a complete range of easy-to-use mechanical, hydraulic and hydraulically-assisted bearing pullers for use in many bearing applications.

Dismounting using heat

The inner rings of cylindrical roller bearings generally have a tight interference fit, which requires high forces to dismount. In such cases, using a puller can cause damage to the shaft and ring, which can be hazardous to the operator. Using heating equipment facilitates easy and quick dismounting while reducing the risk of damage to the ring and shaft. SKF offers a range of heating equipment, which includes aluminium heating rings as well as adjustable and fixed induction heaters, for dismounting cylindrical roller bearing inner rings.

Dismounting bearings using hydraulic techniques

The SKF hydraulic techniques are often the preferred method for dismounting larger bearings as well as other components. These techniques, which employ hydraulic pumps, nuts and oil injectors, allow the application of substantial forces to dismount bearings or other components.

Online mounting and dismounting instructions

At skf.com/mount, SKF offers a unique web-based, free of charge information service for the mounting and dismounting of SKF bearings and bearing housings in 13 languages.

This service provides step-by-step instructions for mounting and dismounting. The system also provides information on proper tools and lubricants. With this free internet service, SKF's expertise is at your fingertips around the clock worldwide.



Mechanical mounting

Helps prevent premature bearing failures

SKF Bearing Fitting Tool Kit TMFT series

Poor fitting, usually using brute force, accounts for 16% of premature bearing failures. SKF Bearing Fitting Tool Kits are designed for quick and precise mounting of bearings, while minimising the risk of bearing damage.

The right combination of impact ring and sleeve allows effective transmission of mounting force to the bearing ring with the interference fit, minimising the risk of damaging the bearing's raceways or rolling elements. In addition to mounting bearings, the TMFT series are also suitable for mounting other components such as bushings, seals and pulleys. The TMFT 36 kit contains 36 impact rings and the TMFT 24 contains 24 rings. Both kits have 3 impact sleeves and a dead-blow hammer packed in a lightweight carrying case.

- The TMFT 36 facilitates the mounting of different bearings with bore diameters from 10–55 mm
- The TMFT 24 facilitates the mounting of different bearings with bore diameters from 15–45 mm
- Facilitates correct mounting on shaft, housing and blind applications
- The diameter of the impact ring precisely fits the inner and outer diameter of the bearing
- Small diameter of the impact area on top of the sleeve allows effective transmission and distribution of mounting force
- Impact rings and sleeves are made of high impact resistant material for longevity
- Click connection between impact ring and sleeve provides stability and durability
- The impact rings are suitable for use under a press
- Impact rings are marked for clear visual identification of the ring's size and easy selection
- Even surface of the impact sleeve's body provides excellent grip
- The nylon double-side head of the dead-blow hammer helps to prevent damaging the components
- The rubber handgrip of the dead-blow hammer provides excellent grip











Technical data











Designation	TMFT 24	TMFT 36
Impact rings		
Bore diameter	15–45 mm (0.59–1.77 in.)	10–55 mm (0.39–2.17 in.)
Outer diameter	32–100 mm (1.26–3.94 in.)	26–120 mm (1.02–4.72 in.)
Sleeves		
Maximum shaft length	Sleeve A: 220 mm (8.7 in.) Sleeve B: 220 mm (8.7 in.) Sleeve C: 225 mm (8.9 in.)	Sleeve A: 220 mm (8.7 in.) Sleeve B: 220 mm (8.7 in.) Sleeve C: 225 mm (8.9 in.)
Hammer	TMFT 36-H, weight 0,9 kg (2.0 lb)	TMFT 36-H, weight 0,9 kg (2.0 lb)
Carrying case dimensions	530 × 110 × 360 mm (20.9 × 4.3 × 14.2 in.)	530 × 110 × 360 mm (20.9 × 4.3 × 14.2 in.)
Number of rings	24	36
Number of sleeves	3	3
Weight (including carrying case)	4,0 kg (8.9 lb)	4,4 kg (9.7 lb)

TMFT 24 is suitable for SKF bearing series

 DGBB	 DGBB (sealed)	 SABB	 SRACBB	 DRACBB	 SRB	 CRB	 TRB	 CARB®
6002-6009 6202-6209 6302-6309 6403-6407 62/22 62/28 63/22 63/28 16002-16009 98203-98206	62202-62209 62302-62309 63002-63009	1202-1209 1302-1309 2202-2209 2302-2309 11207-11209	7002-7009 7202-7209 7302-7309	3202-3209 3302-3309	21305-21309 22205/20 22205-22209 22308-22309	N 1005-N 1009 N 202-N 209 N 2203-N 2209 N 2304-N 2309 N 3004-N 3009 N 303-N 309	30203-30209 30302-30309 31305-31309 32004-32009 32205-32209 32303-32309 33205-33209	C 2205-C 2209 C 6006

TMFT 36 is suitable for SKF bearing series

 DGBB	 DGBB (sealed)	 SABB	 SRACBB	 DRACBB	 SRB	 CRB	 TRB	 CARB®
6000-6011 6200-6211 6300-6311 6403-6409 629 62/22 62/28 63/22 63/28 16002-16011 16100-16101 98203-98206	62200-62211 62300-62311 63000-63010	1200-1211 129 1301-1311 2200-2201 2301-2311 11207-11210	7000-7011 7200-7211 7301-7311	3200-3211 3302-3311	21305-21311 22205/20 22205-22211 22308-22311	N 1005-N 1011 N 202-N 211 N 2203-N 2211 N 2304-N 2311 N 3004-N 3011 N 303-N 311	30203-30211 30302-30311 31305-31311 32004-32011 32205-32211 32303-32311 33010-33011 33205-33211	C 2205-C 2211 C 4010 C 6006

Interference fits on cylindrical shafts

Most bearings are fitted to their shaft or housing with one component having an interference fit. For determining the correct fit, refer to the SKF General Catalogue, the SKF Maintenance Handbook or consult an SKF application engineer.



Incorrect mounting

When bearings are mounted cold, care must be taken to ensure the drive-up forces are applied to the ring with the interference fit. Damage to the bearing resulting in a failure can occur if the mounting force is transmitted through the rolling elements causing damage to the raceways.

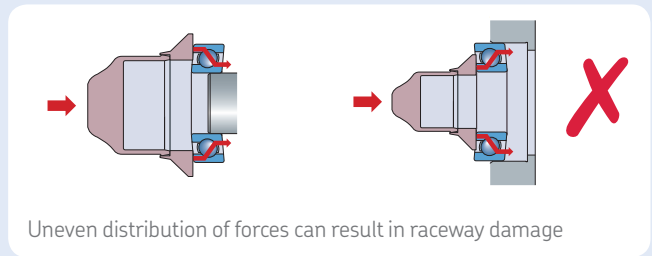

Correct mounting

The correct way to minimise raceway damage is to use specifically designed tools from SKF, such as the Bearing Fitting Tool Kit TMFT 36 and Combi Kit TMMK 10-35. These tools allow drive-up forces to be applied effectively and evenly to the component with the interference fit, avoiding raceway damage.

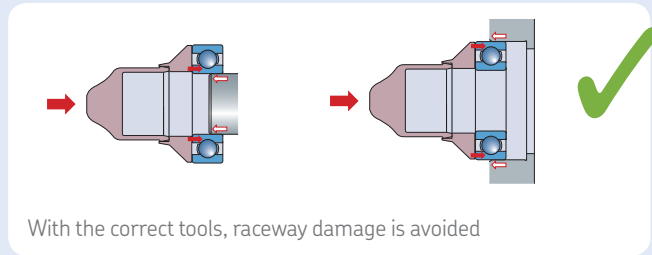

Spanners and sockets

Interference fits on tapered shafts

Bearings mounted on tapered seatings achieve their interference fit by being driven up the tapered shaft. Care should be taken to ensure the bearing is not driven up too far, as all the internal clearance may be removed and damage to the bearing is possible.

Incorrect mounting

Bearing driven up too far and all clearance removed; damage possible.

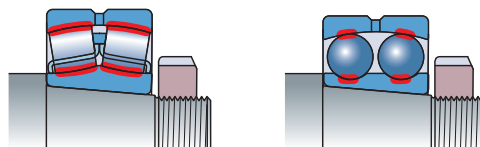

Correct mounting

Bearing driven up the correct distance and the right clearance is achieved.

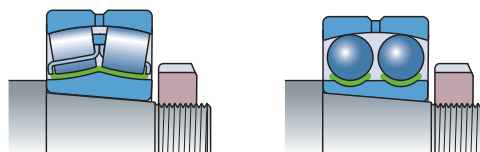

The comprehensive range of SKF spanner and sockets are used to tighten and loosen many types and sizes of bearing lock nuts, for bearings mounted directly on a shaft or on sleeves.



Exact spanner radius reduces the risk of nut damage

SKF Hook Spanners HN series

- Minimises the risk of shaft and nut damage
- Plastic handle is oil, grease and dirt resistant to provide a better grip
- The plastic handle minimises direct metal to skin contact, reducing the risk of corrosion in the handle area
- Spanner designation is laser-engraved allowing for easy identification and selection
- Available as a set: SKF HN 4-16/SET containing 9 spanners for lock nut sizes 4 up to 16

Contents SKF HN 4-16/SET

HN 4	HN 8-9	HN 14
HN 5-6	HN 10-11	HN 15
HN 7	HN 12-13	HN 16

Selection chart – HN series

Designation	Suitable for the following series of SKF lock nuts						
	KM	N	AN	KMK	KMFE	KMT	DIN 1804 (M)
HN 0	0	0		0			M6×0,75, M8×1
HN 1	1	1		1			
HN 2-3	2, 3	2, 3		2, 3		0	M10×1, M12×1,5
HN 4	4	4		4	4	1, 2	M14×1,5, M16×1,5
HN 5-6	5, 6	5, 6		5, 6	5, 6	3, 4, 5	M22×1,5, M24×1,5, M26×1,5
HN 7	7	7		7	7	6, 7	M28×1,5, M30×1,5, M32×1,5, M35×1,5
HN 8-9	8, 9	8, 9		8, 9	8, 9	8	M38×1,5, M40×1,5, M42×1,5
HN 10-11	10, 11	10, 11		10, 11	10, 11	9, 10	M45×1,5, M48×1,5, M50×1,5
HN 12-13	12, 13	12, 13		12, 13	12, 13	11, 12	M52×1,5, M55×1,5, M58×1,5, M60×1,5
HN 14	14		14	14	14		
HN 15	15		15	15	15	13, 14	M62×1,5, M65×1,5, M68×1,5, M70×1,5
HN 16	16		16	16	16	15	
HN 17	17		17	17	17	16	M72×1,5, M75×1,5,
HN 18-20	18, 19, 20		18, 19, 20	18, 19, 20	18, 19, 20	17, 18, 19	M80×2, M85×2, M90×2
HN 21-22	21, 22		21, 22	21, 22	21, 22	20, 22	M95×2, M100×2

Technical data – HN series

Designation	Spanner design DIN 1810		Outer diameter lock nut		Designation	Spanner design DIN 1810		Outer diameter lock nut	
	mm		mm	in.		mm		mm	in.
HN 0			16–20	0.6–0.8	HN 12-13	Ø80–Ø90		80–90	3.1–3.5
HN 1	Ø20–Ø22		20–22	0.8–0.9	HN 14			92	3.6
HN 2-3	Ø25–Ø28		25–28	1.0–1.1	HN 15	Ø95–Ø100		95–100	3.7–3.9
HN 4	Ø30–Ø32		30–32	1.2–1.3	HN 16			105	4.1
HN 5-6			38–45	1.5–1.8	HN 17	Ø110–Ø115		110–115	4.3–4.5
HN 7	Ø52–Ø55		52–55	2.0–2.2	HN 18-20	Ø120–Ø130		120–130	4.7–5.1
HN 8-9			58–65	2.3–2.6	HN 21-22	Ø135–Ø145		135–145	5.3–5.7
HN 10-11	Ø68–Ø75		68–75	2.7–3.0					



Four sizes for tightening or loosening up to 24 nut sizes

SKF Adjustable Hook Spanners HNA series

- One hook spanner covers several nut sizes, making it suitable for use with many applications
- Economic solution: 4 hook spanners cover a wide range of nut sizes
- Laser engraved designation, which represents the range of nut sizes covered by each spanner, allows easy selection of the correct spanner
- Versatile: suitable for a wide selection of lock nuts
- Minimises the risk of shaft and nut damage

Selection chart and technical data – HNA series

Designation	Outer diameter lock nut		Suitable for the following series of SKF lock nuts						
	mm	in.	KM	KML	N	AN	KMK	KMFE	KMT
HNA 1-4	20–35	0.8–1.4	1–4		2–4		0–4	4	0–2
HNA 5-8	35–60	1.4–2.4	5–8		5–8		5–8	5–8	3–7
HNA 9-13	60–90	2.4–3.5	9–13		9–13		9–13	9–13	8–12
HNA 14-24	90–150	3.5–6.1	14–24	24–26		14–24	14–20	14–24	13–24



Easy and quick bearing mounting and dismounting in SNL housings

SKF Hook Spanners HN ./SNL series

- Unique design allows the SKF HN ./SNL series to be used inside SKF SNL, FSNL, SNH and SE bearing housings
- Suitable for tightening and loosening a wide selection of lock nuts, facilitating their use in a wide range of housing and shaft applications
- The large contact area of the spanner around the nut provides excellent grip and force transmission
- Exact fit reduces the risk of shaft, nut and housing damage



Selection chart and technical data

Designation	Outer diameter lock nut		Suitable for SKF housings SNL / FSNL / SNH / SE	Suitable for the following series of SKF lock nuts						
	mm	in.		KM	KML	N*	AN*	KMK*	KMFE	KMT*
HN 5/SNL	38	1.50	505, 506–605	5		5		5	5	5
HN 6/SNL	45	1.77	506–605, 507–606	6		6		6	6	6
HN 7/SNL	52	2.05	507–606, 508–607	7		7		7	7	7
HN 8/SNL	58	2.28	508–607, 510–608	8		8		8	8	8
HN 9/SNL	65	2.56	509, 511–609	9		9		9	9	9
HN 10/SNL	70	2.76	510–608, 512–610	10		10		10	10	10
HN 11/SNL	75	2.95	511–609, 513–611	11		11		11	11	11
HN 12/SNL	80	3.15	512–610, 515–612	12		12		12	12	12
HN 13/SNL	85	3.35	513–611, 516–613	13		13		13	13	13
HN 15/SNL	98	3.86	515–612, 518–615	15			15	15	15	15
HN 16/SNL	105	4.13	516–613, 519–616	16			16	16	16	16
HN 17/SNL	110	4.33	517, 520–617	17			17	17	17	17
HN 18/SNL	120	4.72	518–615	18			18	18	18	18
HN 19/SNL	125	4.92	519–616, 522–619	19			19	19	19	19
HN 20/SNL	130	5.12	520–617, 524–620	20		22	20, 21	20	20	20
HN 22/SNL	145	5.71	522–619	22	24	24	22		22	22
HN 24/SNL	155	6.10	524–620	24	26	26	24		24	24
HN 26/SNL	165	6.50	526	26	28	28	26		26	26
HN 28/SNL	180	7.09	528	28	30	30				
HN 30/SNL	195	7.68	530	30	32	34	30			32
HN 32/SNL	210	8.27	532	32		36				

* Not recommended for use in combination with SNL/SNH housing



Easy mounting and dismounting without nut damage

SKF Axial Lock Nut Sockets TMFS series

- Requires less space around the bearing arrangement than hook spanners
- Inch connections for power tools or torque wrenches
- SKF TMFS fits nuts of series KM, KMK (metric) and KMF
- Special versions are available on request



Selection chart and technical data

Designation	Suitable for nuts of series			Dimensions						Connection
	KM, KMK	KMFE	DIN 1804 (M)	Outer diameter lock nut		Outer diameter socket		Effective height		
				mm	in.	mm	in.	mm	in.	
TMFS 0	0			18	0.7	22,0	0.9	45	1.8	3/8
TMFS 1	1			22	0.9	28,0	1.1	45	1.8	3/8
TMFS 2	2		M10×1	25	1.0	33,0	1.3	61	2.4	1/2
TMFS 3	3		M12×1,5	28	1.1	36,0	1.4	61	2.4	1/2
TMFS 4	4	4	M16×1,5	32	1.3	38,0	1.5	58	2.3	1/2
TMFS 5	5	5		38	1.5	46,0	1.8	58	2.3	1/2
TMFS 6	6	6	M26×1,5	45	1.8	53,0	2.1	58	2.3	1/2
TMFS 7	7	7	M32×1,5	52	2.0	60,0	2.4	58	2.3	1/2
TMFS 8	8	8	M38×1,5	58	2.3	68,0	2.7	58	2.3	1/2
TMFS 9	9	9		65	2.6	73,5	2.9	63	2.5	3/4
TMFS 10	10	10		70	2.8	78,5	3.1	63	2.5	3/4
TMFS 11	11	11	M48×1,5, M50×1,5	75	3.0	83,5	3.3	63	2.5	3/4
TMFS 12	12	12	M52×1,5, M55×1,5	80	3.1	88,5	3.5	63	2.5	3/4
TMFS 13	13	13		85	3.3	94,0	3.7	63	2.5	3/4
TMFS 14	14	14		92	3.6	103,0	4.1	80	3.2	1
TMFS 15	15	15		98	3.9	109,0	4.3	80	3.2	1
TMFS 16	16	16		105	4.1	116,0	4.6	80	3.2	1
TMFS 17	17	17	M72×1,5, M75×1,5	110	4.3	121,0	4.8	80	3.2	1
TMFS 18	18	18		120	4.7	131,0	5.2	80	3.2	1
TMFS 19	19	19	M85×2	125	4.9	137,0	5.5	80	3.2	1
TMFS 20	20	20	M90×2	130	5.1	143,0	5.7	80	3.2	1



High impact forces without nut damage

SKF Impact Spanners TMFN series

- Helps avoid shaft and nut damage
- Safe and user friendly
- Impact applied effectively to the nut
- Suitable for a wide selection of lock nuts
- Special wide impact face
- To be used in combination with a hammer

Suitable for nuts of series

Designation	KMT ..	KM ..	KML ..	KMFE ..	HM .. (HM .. E)	HM .. T	AN ..	N ..	DIN 1804 (M)
TMFN 23-30	26-30	23-31	26-32	24-28			AN22-AN28	N022-N032	M105x2-M130x3
TMFN 30-40	32-40	32-40	34-40	30-38			AN30-AN38	N034-N040	M140x3-M180x3
TMFN 40-52				40	3044-3052	42-48	AN40	N044-N052 N44	M190x3, M200x3
TMFN 52-64					3056-3064 3160	50, 52, 56		N056-N064	
TMFN 64-80					3068-3084 3164-3176			N068-N084	
TMFN 80-500					3088-3096 3180-3196 30/500			N088-N096 N500	
TMFN 500-600					30/530-30/630 31/500-31/560			N530-N630	
TMFN 600-750					30/670-30/800 31/600-31/750			N670-N800	

Suitable for adapter sleeves

Designation	H 23..	H 30..	H 31..	H32	H39
TMFN 23-30	H2324 - H2332L	H3024E - H3032	H3124 - H3130L		H3926 - H3932
TMFN 30-40	H2332 - H2340	H3030E, H3034 - H3040	H3132 - H3140L		H3934 - H3940
TMFN 40-52	OH2344H, OH2348H	OH3044H - OH3052H	H3144H(HTL) - H3152HTL		H3944H - H3952H
TMFN 52-64	OH2352H, OH2356H	OH3056H - OH3064H	OH3152H - OH3160H	OH3260H	OH3956H - OH3964H
TMFN 64-80		OH3068 H - OH3084H	OH3164H - OH3176H(E)	OH3264H - OH3276 H	OH3968H - OH3984H(E)
TMFN 80-500		OH30/500H, OH3080H - 3096H	OH3180H(E) - OH3196H(E)	OH3280H - OH3296 H	OH39/500H(E), OH3988H - OH3996H(E)
TMFN 500-600		OH30/530H - OH30/630H	OH31/530H - OH31/560H(E)	OH32/500H - OH32/560H	OH39/530H(E) - OH39/630H(E)
TMFN 600-750		OH30/670H - OH30/800H(E)	OH31/600H - OH31/750H(E)	OH32/600H - OH32/750H	OH39/670H(E) - OH39/800H(E)

Technical data

Designation	Lock nut outer diameter	Weight spanner
TMFN 23-30	150-190 mm (5.9-7.5 in.)	1,10 kg (2.3 lb)
TMFN 30-40	195-245 mm (7.7-9.6 in.)	1,80 kg (4.0 lb)
TMFN 40-52	250-310 mm (9.8-12.2 in.)	3,10 kg (6.9 lb)
TMFN 52-64	320-385 mm (12.6-15.2 in.)	3,70 kg (8.1 lb)
TMFN 64-80	400-495 mm (15.7-19.5 in.)	4,30 kg (9.5 lb)
TMFN 80-500	520-620 mm (20.5-24.4 in.)	6,90 kg (15.2 lb)
TMFN 500-600	630-735 mm (24.8-28.9 in.)	8,50 kg (18.8 lb)
TMFN 600-750	750-950 mm (29.5-37.4 in.)	11,00 kg (24.3 lb)



TMFN 23-30 and TMFN 30-40

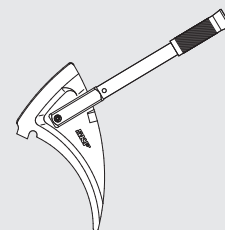

Other sizes TMFN impact spanners



For achieving the correct radial clearance

SKF Bearing Lock Nut Spanner TMHN 7 series

The SKF TMHN 7 set of lock nut spanners is especially designed for mounting self-aligning ball bearings as well as small spherical roller and CARB toroidal roller bearings on tapered seatings. Using the SKF TMHN 7, minimises the risk of over-tightening of the lock nut, which can remove the bearing's radial clearance resulting in bearing damage.

- 7 different-sized spanners to fit nut sizes 5 to 11
- Each spanner is equipped with a protractor and is clearly marked with the correct tightening angle for mounting SKF Self-aligning ball bearings
- 4 grip points on each spanner provide a better and safer grip on the nut
- Reduced risk of damaging bearing by over-tightening
- Suitable for use with lock nuts of the KM series either on shaft or in SNL housings

TMHN 7 is suitable for use with:

Bearing designation

1205 EK-1211 EK
 1306 EK-1311 EK
 2205 EK-2211 EK
 2306 K
 2307 EK-2309 EK
 2310 K-2311 K

Technical data

Designation	TMHN 7
Carrying case dimensions	340 × 250 × 80 mm (13.4 × 9.8 × 3.1 in.)
Weight	2,2 kg (4.7 lb)

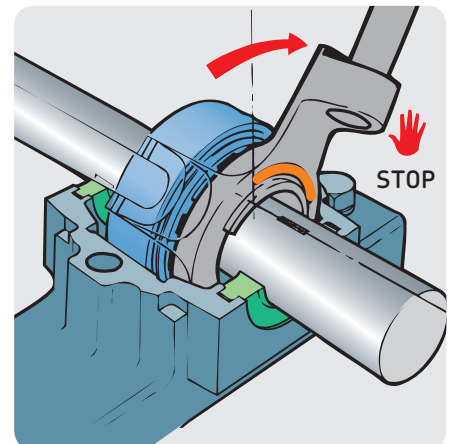
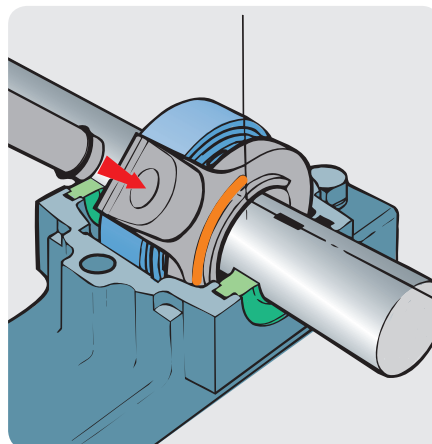
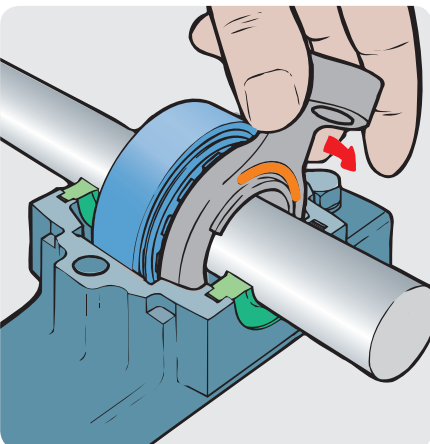

Mounting and dismounting



TMMK 10-35



TMMK 20-50

Multi-purpose kits for quick and easy mounting and dismounting

SKF Combi Kit TMMK series

The SKF TMMK series designed for the quick and precise mounting and dismounting of deep groove ball bearings from shafts, housings and blind housings.

For mounting, a multi-purpose fitting tool is included which is suitable for mounting bearings as well as bushings, seal rings, belt pulleys and other similar products. For dismounting of deep groove ball bearings from blind housings and shafts, the SKF TMMK series contains a unique three-armed puller. When dismounting deep groove ball bearings from housings, a combination of this puller, sliding hammer and support rings enables easy removal of the bearings.

- The correct combination of a tough and lightweight impact ring and sleeve reduces the risk of bearing damage as the impact force is not transmitted through the rolling elements
- The dead-blow hammer is designed for maximum impact, while the puller claws are specially designed to provide a good grip and allow for high dismounting forces
- All parts are clearly arranged in the case for easy selection and identification

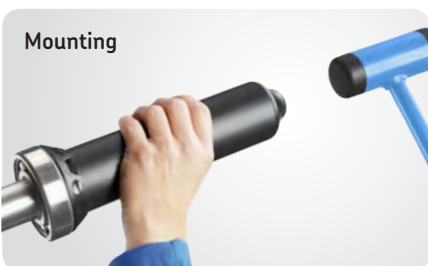

Mounting

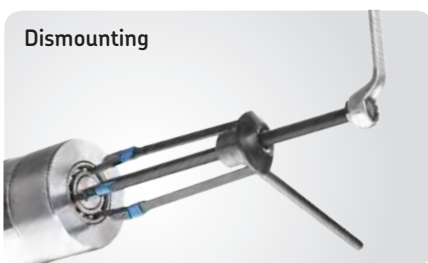

Dismounting

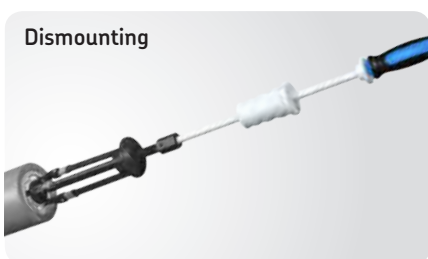

Dismounting

Suitability chart

TMMK 10-35 is suitable for dismounting the following SKF deep groove ball bearings

60.. series	62.. series	63.. series	64.. series	16... series
6000–6017	6200–6211	6300–6307	6403	16002–16003
	62/22	63/22		16011
	62/28	63/28		

TMMK 20-50 is suitable for dismounting the following SKF deep groove ball bearings

60.. series	62.. series	63.. series	64.. series	16... series
6004–6020	6201–6218	6300–6313	6403–6310	16011
	62/22	63/22		
	62/28	63/28		

Technical data

Designation	TMMK 10-35	TMMK 20-50
Number of impact rings	24	21
Number of sleeves	2	2
Impact rings bore diameter	10–35 mm (0.39–1.38 in.)	20–50 mm (0.79–1.97 in.)
Impact rings outer diameter	26–80 mm (1.02–3.15 in.)	42–110 mm (1.65–4.33 in.)
Dead-blow hammer	TMFT 36-H	TMFT 36-H
Dimensions of case	530 × 110 × 360 mm (20.9 × 4.3 × 14.2 in.)	530 × 110 × 360 mm (20.9 × 4.3 × 14.2 in.)
Weight	7,6 kg (16.8 lb)	8,5 kg (18.6 lb)

Dismounting

Selection chart – SKF external pullers

	Designation	Width of grip		Effective arm length			
		mm	in.	mm	in.		
 i 22	SKF Standard Jaw Pullers						
	TMMP 2x65	15–65	0.6–2.6	60	2.4		
	TMMP 2x170	25–170	1.0–6.7	135	5.3		
	TMMP 3x185	40–185	1.6–7.3	135	5.3		
	TMMP 3x230	40–230	1.6–9.0	210	8.3		
	TMMP 3x300	45–300	1.8–11.8	240	9.4		
 i 25	SKF Reversible Jaw Pullers						
	TMMR 40F	23–48	0.9–1.9	67	2.6		
	TMMR 60F	23–68	0.9–2.7	82	3.2		
	TMMR 80F	41–83	1.6–3.3	98	3.9		
	TMMR 120F	41–124	1.6–4.9	124	4.9		
	TMMR 160F	68–164	2.7–6.5	143	5.6		
	TMMR 200F	65–204	2.6–8.0	169	6.7		
	TMMR 250F	74–254	2.9–10.0	183	7.2		
	TMMR 350F	74–354	2.9–13.9	238	9.4		
	TMMR 160XL	42–140	1.7–5.5	221	8.7		
	TMMR 200XL	42–180	1.7–7.1	221	8.7		
TMMR 250XL	44–236	1.7–9.3	221	8.7			
TMMR 350XL	44–336	1.7–13.2	221	8.7			
 i 22	SKF Heavy Duty Jaw Pullers						
	TMMP 6	50–127	2.0–5.0	120*	4.7*		
	TMMP 10	100–223	3.9–8.7	207*	8.2*		
	TMMP 15	140–326	5.5–12.8	340*	13.4*		
 i 20	Mechanical pullers SKF EasyPull						
	TMMA 60	36–150	1.4–5.9	150	5.9		
	TMMA 80	52–200	2.0–7.8	200	7.8		
	TMMA 120	75–250	3.0–9.8	250	9.8		
	Hydraulic pullers SKF EasyPull						
	TMMA 75H + .../SET	52–200	2.0–7.8	200	7.8		
TMMA 100H + .../SET	75–250	3.0–9.8	250	9.8			
 i 24, 26	SKF Hydraulic Jaw Puller Kit						
	TMHP 10E	75–280	3.0–11.0	110–200	4.3–7.9		
	SKF Hydraulic Puller Kit						
TMHC 110E	50–170	1.9–6.7	70–120	2.8–4.7			
 i 23	SKF Hydraulically Assisted Heavy Duty Jaw Pullers						
	TMHP 15/260	195–386	7.7–15.2	264*	10.4*		
	TMHP 30/170	290–500	11.4–19.7	170*	6.7*		
	TMHP 30/350	290–500	11.4–19.7	350*	13.7*		
	TMHP 30/600	290–500	11.4–19.7	600*	23.6*		
	TMHP 50/140	310–506	12.2–19.9	140*	5.5*		
	TMHP 50/320	310–506	12.2–19.9	320*	12.6*		
	TMHP 50/570	310–506	12.2–19.9	570*	22.4*		

* Other arm length options are available

SKF EasyPull

Equipped with spring-operated arms and a solid design, the patented SKF EasyPull is one of the most user-friendly and safe tools on the market. Ergonomically designed, the spring-operated arms enable the user to position the puller behind the component with just one movement. The SKF EasyPull is available in mechanical and hydraulically assisted versions, as well as complete kits with a tri-section pulling plate and a puller protection blanket.



Safe and simple bearing dismounting

Mechanical pullers TMMA series

- Sturdy design allows dismounting of components even in the tightest application in a safe manner
- The unique red rings spring-operated opening mechanism allows the SKF EasyPull to be placed behind the component with one movement of the hands
- Self-locking arms help prevent the risk of puller slipping under load
- Double hexagonal heads allow easier application of withdrawal force
- Self-centring capability and nosepiece help avoid damage to shaft
- Efficient use of time due to quick dismounting
- Available in three sizes with a withdrawal force of 60, 80 or 120 kN (6.7, 9.0 or 13.5 US ton), enabling easy selection
- TMHS series hydraulic force generators are available as an accessory for the 80 and 120 kN versions

Quick and virtually effortless bearing dismounting

Hydraulic pullers TMMA ..H series

- Ready-to-use, integrated hydraulic cylinder, pump and puller – thus it is assembly-free and it is not necessary to purchase separate parts
- Safety valve prevents spindles and pullers from being overloaded if excessive force is applied
- The spring-loaded centre point on the hydraulic spindle allows easy centring of the puller on the shaft without damaging the shaft
- The TMMA 100H has a maximum withdrawal force of 100 kN (11.2 US ton) and a long stroke of 80 mm (3.1 in.), which facilitates most dismounting jobs in just one operation
- For dismounting jobs requiring less force, SKF offers a 75 kN (8.4 US ton) version, the hydraulic EasyPull TMMA 75H with a maximum stroke of 75 mm (3 in.)
- Supplied with extension pieces and one nosepiece

Technical data

Designation	TMMA 60	TMMA 80	TMMA 120	TMMA 75H	TMMA 100H
Width of grip external, minimum	36 mm (1.4 in.)	52 mm (2.0 in.)	75 mm (3.0 in.)	52 mm (2 in.)	75 mm (3 in.)
Width of grip external, maximum	150 mm (5.9 in.)	200 mm (7.8 in.)	250 mm (9.8 in.)	200 mm (7.8 in.)	250 mm (9.8 in.)
Effective arm length	150 mm (5.9 in.)	200 mm (7.8 in.)	250 mm (9.8 in.)	200 mm (7.8 in.)	250 mm (9.8 in.)
Maximum withdrawal force	60 kN (6.7 US ton)	80 kN (9.0 US ton)	120 kN (13.5 US ton)	75 kN (8.4 US ton)	100 kN (11.2 US ton)
Claw height	7,5 mm (0.30 in.)	9,8 mm (0.39 in.)	13,8 mm (0.54 in.)	9,8 mm (0.39 in.)	13,8 mm (0.54 in.)
Hydraulic spindle	–	–	–	TMHS 75	TMHS 100
Adapter: possible to upgrade to hydraulic version	–	TMHS 75	TMHS 100	–	–
Total weight	4,0 kg (8.8 lb)	5,7 kg (12.6 lb)	10,6 kg (23.4 lb)	7,0 kg (15.4 lb)	13,2 kg (29 lb)



A complete bearing dismounting solution

Hydraulic puller sets TMMA ..H /SET series

- A set consisting of a hydraulically assisted SKF EasyPull together with a tri-section pulling plate, TMMS series, and a puller protection blanket facilitate an easy, safe and virtually damage-free dismounting
- Especially suitable for dismounting spherical roller and CARB toroidal roller bearings, and other components such as pulleys and flywheels
- A puller protection blanket, TMMX series, made of a strong transparent material allows the user to visually follow the dismounting procedure. While dismounting, the blanket helps to protect from flying fragments of bearings or other components, thereby enhancing user safety
- A sturdy custom-made storage case with room for all parts minimises the risk of losing or damaging the set's components

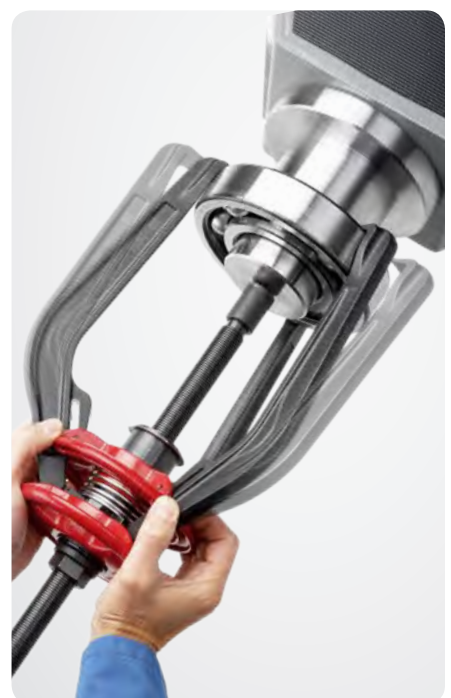

Technical data

Designation	TMMA 75H/SET	TMMA 100H/SET
Puller	TMMA 75H	TMMA 100H
Tri-section pulling plate	TMMS 100	TMMS 160
Puller protection blanket	TMMX 280	TMMX 350
Dimensions of case	600 × 235 × 225 mm (23.6 × 9.3 × 8.6 in.)	680 × 320 × 270 mm (27 × 13 × 11 in.)
Total weight	15,0 kg (33.1 lb)	31,6 kg (70 lb)

SKF Jaw pullers

One of the most common ways to dismount small to medium size bearings is to use a basic mechanical puller. Using an SKF puller helps to safeguard against damage to the bearing or to the bearing seating during dismounting. SKF Jaw pullers allow for easy and safe puller operation.



Versatile two and three arm mechanical pullers

SKF Standard Jaw Pullers TMMP series

- Range of five different jaw pullers with two or three arms
- Maximum nominal span from 65 to 300 mm (2.6 to 11.8 in.)
- Cone system for automatic centring and secure positioning of arms
- Strong springs keep arms apart for easy operation
- Hardened, high quality carbon steel

Powerful self-centring mechanical pullers

SKF Heavy Duty Jaw Pullers TMMP series

- Fast, efficient and smooth handling
- Unique pantograph system gives exceptional grip and helps counteract misalignment during operation
- Three arm jaw pullers with a maximum withdrawal force of 60 to 150 kN (6.7 to 17.0 US ton) suitable for medium to large size bearings
- Blackened, high quality steel for corrosion resistance
- Other arm length options are available

Technical data – SKF Standard Jaw Pullers

Designation	TMMP 2x65	TMMP 2x170	TMMP 3x185	TMMP 3x230	TMMP 3x300
No. of arms	2	2	3	3	3
Width of grip	15–65 mm (0.6–2.6 in.)	25–170 mm (1.0–6.7 in.)	40–185 mm (1.6–7.3 in.)	40–230 mm (1.6–9.1 in.)	45–300 mm (1.8–11.8 in.)
Effective length of arms	60 mm (2.4 in.)	135 mm (5.3 in.)	135 mm (5.3 in.)	210 mm (8.3 in.)	240 mm (9.4 in.)
Claw height	8 mm (0.31 in.)	9 mm (0.35 in.)	9 mm (0.35 in.)	9 mm (0.35 in.)	11 mm (0.43 in.)
Maximum withdrawal force	6,0 kN (0.7 US ton)	18,0 kN (2 US ton)	24,0 kN (2.7 US ton)	34,0 kN (3.8 US ton)	50,0 kN (5.6 US ton)
Weight	0,5 kg (1.2 lb)	2,1 kg (4.7 lb)	2,9 kg (6.4 lb)	5,8 kg (13 lb)	8,6 kg (19 lb)

Technical data – SKF Heavy Duty Jaw Pullers

Designation	TMMP 6	TMMP 10	TMMP 15
Width of grip	50–127 mm (2.0–5.0 in.)	100–223 mm (3.9–8.7 in.)	140–326 mm (5.5–12.8 in.)
Effective length of arms	120 mm (4.7 in.)	207 mm (8.2 in.)	340 mm (13.4 in.)
Claw height	15 mm (0.59 in.)	20 mm (0.78 in.)	30 mm (1.18 in.)
Maximum withdrawal force	60 kN (6.7 US ton)	100 kN (11.2 US ton)	150 kN (17 US ton)
Weight	4,0 kg (8.8 lb)	8,5 kg (19 lb)	21,5 kg (46 lb)
Effective length optional arms			
TMMP ...-1	included	included	260 mm (10.2 in.)
TMMP ...-2	220 mm (8.6 in.)	350 mm (13.8 in.)	included
TMMP ...-3	370 mm (14.5 in.)	460 mm (18.1 in.)	435 mm (17.1 in.)
TMMP ...-4	470 mm (18.5 in.)	710 mm (27.9 in.)	685 mm (27.0 in.)





Powerful self-centring hydraulic pullers

SKF Hydraulically Assisted Heavy Duty Jaw Pullers TMHP series

- High forces can be easily applied as the puller is self-centring
- The combination of a spindle and hydraulic cylinder allows the working length to be easily adjusted
- Unique pantograph system gives exceptional grip and helps counteract misalignment during operation
- Equipped with a lifting handle and eye bolt, facilitates easy handling
- Maximum withdrawal force of 150, 300 or 500 kN (17, 34 or 56 US ton)
- Supplied with SKF Hydraulic Pump TMJL 100

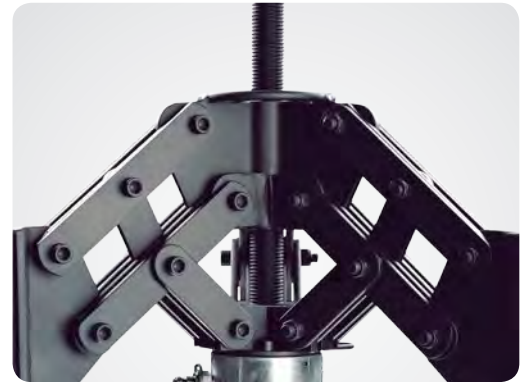

Technical data

Designation*	TMHP 15/260	TMHP 30/170	TMHP 30/350	TMHP 30/600	TMHP 50/140	TMHP 50/320	TMHP 50/570
Width of grip	195–386 mm (7.7–15.2 in.)	290–500 mm (11.4–19.7 in.)	290–500 mm (11.4–19.7 in.)	290–500 mm (11.4–19.7 in.)	310–506 mm (12.2–19.9 in.)	310–506 mm (12.2–19.9 in.)	310–506 mm (12.2–19.9 in.)
Effective length of arms	264 mm (10.4 in.)	170 mm (6.7 in.)	350 mm (13.7 in.)	600 mm (23.6 in.)	140 mm (5.5 in.)	320 mm (12.6 in.)	570 mm (22.4 in.)
Claw height	30 mm (1.2 in.)	35 mm (1.4 in.)	35 mm (1.4 in.)	35 mm (1.4 in.)	40 mm (1.6 in.)	40 mm (1.6 in.)	40 mm (1.6 in.)
Stroke	100 mm (3.9 in.)	50 mm (2 in.)	50 mm (2 in.)	50 mm (2 in.)	40 mm (1.6 in.)	40 mm (1.6 in.)	40 mm (1.6 in.)
Maximum working pressure hydraulic cylinder	80 MPa (11 600 psi)	80 MPa (11 600 psi)	80 MPa (11 600 psi)	80 MPa (11 600 psi)	80 MPa (11 600 psi)	80 MPa (11 600 psi)	80 MPa (11 600 psi)
Maximum withdrawal force	150 kN (17 US ton)	300 kN (34 US ton)	300 kN (34 US ton)	300 kN (34 US ton)	500 kN (56 US ton)	500 kN (56 US ton)	500 kN (56 US ton)
Weight	34 kg (75 lb)	45 kg (99 lb)	47 kg (104 lb)	56 kg (123 lb)	47 kg (104 lb)	54 kg (119 lb)	56 kg (132 lb)
Effective length optional arms							
TMHP ...-1	included	included	170 mm (6.7 in.)	170 mm (6.7 in.)	included	140 mm (5.5 in.)	140 mm (5.5 in.)
TMHP ...-2	344 mm (14.2 in.)	350 mm (13.7 in.)	included	350 mm (13.7 in.)	320 mm (12.6 in.)	included	320 mm (12.6 in.)
TMHP ...-3	439 mm (17.3 in.)	600 mm (23.6 in.)	600 mm (23.6 in.)	included	570 mm (22.4 in.)	570 mm (22.4 in.)	included
TMHP ...-4	689 mm (27.1 in.)	–	–	–	–	–	–

*Also available without hydraulic pump TMJL 100. Please add suffix 'X' to designation when ordering without pump (e.g. TMHP 30/170X)

TMMR.. XL with 2 optional extension pieces



Versatile and robust pullers for internal and external pulling jobs

SKF Reversible Jaw Puller TMMR F series

The multi-purpose SKF Reversible Jaw Pullers are suitable for internal and external pulling of bearings and other components, such as gears and pulleys. The standard range of eight pullers can accommodate a wide range of bearing and component sizes. Adding extra versatility to the TMMR..F puller programme, the four largest sizes are also available with extra long arms as a standard option (TMMRXL). The extra long arms help to dismount bearings and components placed far from the shaft end. For more versatility, the extra long arms can be further extended by adding extension pieces.

- An essential and versatile tool for every workshop allows for external and internal pulling applications.
- Self-locking arms for easy adjustment of width of grip.
- Hexagonal head on beam enables rotation of puller and bearing during dismounting, improving ease of use.
- Wide gripping range from 23 mm (0.9 in.) internal to 350 mm (13.8 in.) external, enables many bearings and components to be dismounted.
- Unlike many similar pullers, the pullers can be used up to their full rated load capacity without permanently deforming the puller arms.
- Arms and beam are chrome plated for enhanced corrosion resistance and easy cleaning.
- The extra long arm extension pieces, designed to be easy to fit and remove, can be used to further increase the effective arm length. Using extension pieces does not compromise the overall puller strength.
- The SKF Reversible Jaw Pullers can also be supplied as three different sets, complete with a workshop stand.

Technical data

	Designation	Maximum withdrawal force		Width of grip external pull (D)		Width of grip internal pull (d)		Effective arm length (L)	
		kN	ton(US)	mm	in.	mm	in.	mm	in.
	TMMR 40F	17	1.9	23-48	0.9-1.9	59-67	2.3-2.6	67	2.6
	TMMR 60F	17	1.9	23-68	0.9-2.7	62-87	2.4-3.4	82	3.2
	TMMR 80F	40	4.5	41-83	1.6-3.3	95-97	3.7-3.8	98	3.9
	TMMR 120F	40	4.5	41-124	1.6-4.9	95-139	3.7-5.5	124	4.9
	TMMR 160F	50	5.6	68-164	2.7-6.5	114-163	4.5-6.4	143	5.6
	TMMR 200F	50	5.6	65-204	2.6-8.0	114-204	4.5-8.0	169	6.7
	TMMR 250F	60	6.7	74-254	2.9-10.0	132-254	5.2-10.0	183	7.2
	TMMR 350F	60	6.7	74-354	2.9-13.9	135-354	5.3-13.9	238	9.4
	TMMR 160XL	50	5.6	42-140	1.7-5.5	121-188	4.8-7.4	221	8.7
	TMMR 200XL	50	5.6	42-180	1.7-7.1	121-228	4.8-9.0	221	8.7
	TMMR 250XL	60	6.7	44-236	1.7-9.3	123-284	4.8-11.2	221	8.7
	TMMR 350XL	60	6.7	44-336	1.7-13.2	123-384	4.8-15.1	221	8.7

Set contents

	Designation	TMMR 4F/SET	TMMR 8F/SET	TMMR 8XL/SET
 <p>TMMR.. F</p> <p>TMMR 16/35XL-5</p> <p>TMMR 16/20XL-1</p> <p>TMMR 25/35XL-1</p>	TMMR 40F	–	✓	✓
	TMMR 60F	✓	✓	✓
	TMMR 80F	–	✓	✓
	TMMR 120F	✓	✓	✓
	TMMR 160F	✓	✓	✓
	TMMR 200F	–	✓	✓
	TMMR 250F	✓	✓	✓
	TMMR 350F	–	✓	✓
	TMMR 16/20XL-1	–	–	✓
	TMMR 25/35XL-1	–	–	✓
	TMMR 16/35XL-5	–	✓	–

Accessories

TMMR 16/20XL-1	Extra long arm set to convert TMMR 160F and TMMR 200F to XL version
TMMR 25/35XL-1	Extra long arm set to convert TMMR 250F and TMMR 350F to XL version
TMMR 16/35XL-4	Extension arms set for the TMMR.. XL
TMMR 16/35XL-5	Spring-loaded nose piece



Effortless bearing dismounting up to 100 kN

SKF Hydraulic Jaw Puller Kit TMHP 10E

- A versatile kit with three different arm lengths is suitable for a wide range of applications
- Hydraulic spindle facilitates effortless dismounting
- Self-locking arms minimise the risk of the puller slipping from the application when under load
- The spring-loaded centre point of the hydraulic spindle allows easy puller centring
- The hydraulic spindle is equipped with a safety valve, which minimises the risk of puller overload
- High load rating of 100 kN (11.2 US ton) makes the puller suitable for a variety of dismounting jobs
- A hydraulic spindle stroke of 80 mm (3.1 in.) helps facilitate dismounting in one operation
- Supplied with hydraulic spindle extension pieces to allow quick adaptation to pulling length

Technical data

Designation **TMHP 10E**

Contents

- 1 × arm-assembly stand
- 3 × arms, 110 mm (4.3 in.)
- 3 × arms, 160 mm (6.3 in.)
- 3 × arms, 200 mm (7.9 in.)
- 1 × hydraulic spindle TMHS 100
- 3 × extension pieces for hydraulic spindle; 50, 100, 150 mm (2, 4, 6 in.)
- 1 × nosepiece with centre point for hydraulic spindle

Maximum stroke	80 mm (3.1 in.)
Threading hydraulic cylinder	1 1/2-16 UN
Nominal working force	100 kN (11.2 US ton)
Carrying case dimensions	578 × 410 × 70 mm (23 × 16 × 2.8 in.)
Weight	14,5 kg (32 lb)

SKF Strong Back Pullers

Easy bearing dismounting even in the tightest spaces

SKF Strong Back Pullers TMBS E series

The SKF TMBS E strong back pullers facilitate dismounting of bearings in applications where the use of traditional jaw pullers is restricted due to lack of space or where the application demands a long reach.

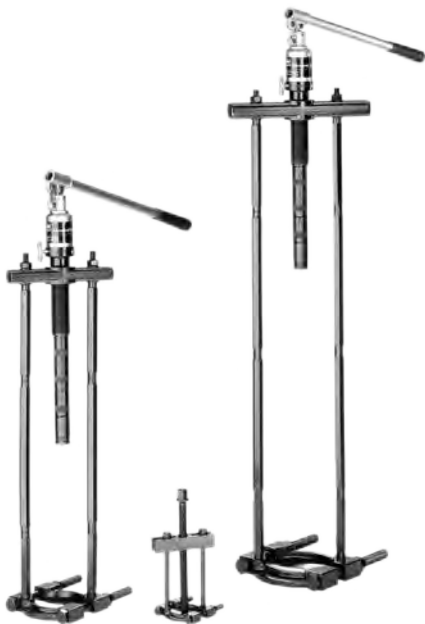

- Special separator design allows the puller to be easily inserted between the bearing and the shoulder on the shaft
- The spring-loaded centre point of the hydraulic spindle allows easy puller centring
- The firm grip behind the bearing's inner ring reduces the force required to dismount the bearing
- The hydraulic spindle is equipped with a safety valve, which minimises the risk of puller overload
- A hydraulic spindle stroke of 80 mm (3.1 in.) helps facilitate dismounting in one operation
- SKF TMBS 50E is equipped with a mechanical spindle for force generation
- SKF TMBS 100E and the SKF TMBS 150E are equipped with a hydraulic spindle, which allows for easy application of force up to 100 kN (11.2 US ton)
- Supplied with hydraulic spindle extension pieces to allow quick adaptation to pulling length
- SKF TMBS 100E and SKF TMBS 150E are supplied with extension rods to allow quick adaptation to pulling lengths upto 816 mm (32.1 in.)

Selection chart

Designation	Shaft diameter		Maximum bearing outer diameter		Maximum reach	
	mm	in.	mm	in.	mm	in.
TMBS 50E	7–50	0.3–1.9	85	3.3	110	4.3
TMBS 100E	20–100	0.8–3.9	160	6.3	120–816	4.7–32.1
TMBS 150E	35–150	1.4–5.9	215	8.5	120–816	4.7–32.1
TMHC 110E	20–100	0.8–3.9	160	6.3	120–245	4.7–9.6

Powerful combination of a jaw and strong back puller

SKF Hydraulic Puller Kit TMHC 110E



- SKF TMHC 110E hydraulic puller kit combines a jaw puller and a strong back puller
- A versatile puller kit facilitates safe and easy dismounting in a variety of applications
- Hydraulic spindle facilitates easy and quick dismounting
- High load rating of 100 kN (11.2 US ton)
- The strong back puller includes two different arm lengths for maximum reach of 120 mm (4.7 in.)
- The jaw puller can be assembled as a three-arm or two-arm puller depending on the space and demands of the application
- The firm grip of the strong back puller behind the bearing's inner ring reduces the force required to dismount the bearing
- Supplied with extension rods to allow quick adaptation to pulling lengths upto 245 mm (9.6 in.)

Technical data – TMBS E series



Designation	TMBS 50E	TMBS 100E	TMBS 150E
Contents	1 × separator set 1 × mechanical spindle 1 × beam 2 × main rods	1 × separator set 2 × main rods 2 × extension rods, 125 mm (4.9 in.) 4 × extension rods, 285 mm (11.2 in.) 1 × beam 1 × hydraulic spindle TMHS 100 2 × extension pieces for hydraulic spindle; 50, 100 mm (2.0, 3.9 in.) 1 × nosepiece with centre point for hydraulic spindle	1 × separator set 2 × main rods 2 × extension rods, 125 mm (4.9 in.) 4 × extension rods, 285 mm (11.2 in.) 1 × beam 1 × hydraulic spindle TMHS 100 2 × extension pieces for hydraulic spindle; 50, 100 mm (2.0, 3.9 in.) 1 × nosepiece with centre point for hydraulic spindle
Maximum stroke	–	80 mm (3.1 in.)	80 mm (3.1 in.)
Nominal working force	30 kN (3.4 US ton)	100 kN (11.2 US ton)	100 kN (11.2 US ton)
Maximum reach	110 mm (4.3 in.)	120–816 mm (4.7–31.1 in.)	120–816 mm (4.7–31.1 in.)
Shaft diameter range	7–50 mm (0.3–2 in.)	20–100 mm (0.8–4 in.)	35–150 mm (1.4–6 in.)
Threading hydraulic cylinder	–	1 1/2–16 UN	1 1/2–16 UN
Carrying case dimensions	295 × 190 × 55 mm (11.6 × 7.5 × 2 in.)	580 × 410 × 70 mm (23 × 16 × 2.8 in.)	580 × 410 × 70 mm (23 × 16 × 2.8 in.)
Weight	1,8 kg (4 lb)	13,5 kg (29.8 lb)	17 kg (37.5 lb)

Technical data – TMHC 110E



Designation	TMHC 110E		
Contents	1 × arm-assembly stand 3 × arms, 60 mm (2.4 in.) 3 × arms, 120 mm (4.7 in.) 1 × separator set 1 × beam 2 × main rods 2 × extension rods, 125 mm (4.9 in.) 1 × hydraulic spindle TMHS 100 2 × extension pieces for hydraulic spindle; 50, 100 mm (2.0, 3.9 in.) 1 × nosepiece with centre point for hydraulic spindle	Arms set 1 (3 × TMHP10E-9)	
		Effective arms length	65 mm (2.5 in.)
		Width of grip	50–110 mm (2–4.3 in.)
		Claw height	6 mm (0.25 in.)
		Arms set 2 (3 × TMHP10E-10)	
		Effective arms length	115 mm (4.5 in.)
		Width of grip	75–170 mm (3.0–6.7 in.)
		Claw height	6 mm (0.25 in.)
		Strong back puller	
		Maximum reach	250 mm (9.8 in.)
		Shaft diameter range	20–100 mm (0.8–4 in.)
Maximum stroke	80 mm (3.1 in.)		
Nominal working force	100 kN (11.2 US ton)		
Threading hydraulic cylinder	1 1/2–16 UN		
Carrying case dimensions	580 × 410 × 70 mm (23 × 16 × 2.8 in.)		
Weight	13,5 kg (29.8 lb)		

SKF Blind housing pullers

Selection chart – SKF Blind pullers

Designation	Bearing bore diameter (d)	Effective arm length
TMMD 100	10–100 mm (0.4–3.9 in.)	135–170 mm (5.3–6.7 in.)
TMBP 20E	30–160 mm (1.2–6.3 in.)	547 mm (21.5 in.)

The SKF Deep Groove Ball Bearing Puller Kit TMMD 100 allows quick and easy dismounting of SKF Deep Groove Ball Bearings with an interference fit on both rings.

The SKF Blind Housing Puller Kit TMBP 20E is an adapter type puller for dismounting deep groove ball bearings in blind housings with shaft dimensions between 30 mm and 160 mm (1.18–6.3 in.). The use of extension rods allows a long reach of up to 547 mm (21.5 in.).

i 30



Removes bearing without dismantling machinery

SKF Blind Housing Puller Kit TMBP 20E

- Allows a wide range of deep groove ball bearings to be dismounted
- Ball adapters designed for a long service life
- Spanner stop function on spindle for easy and safe handling
- Self-locking nose piece helps minimise damage to shaft, and improves puller stability

Suitability chart

SKF TMBP 20E is suitable for dismounting the following deep groove ball bearings

60.. series	62.. series	63.. series	64.. series	16... series
6021–6032	6213–6230	6309–6320	6406–6418	16026–16032

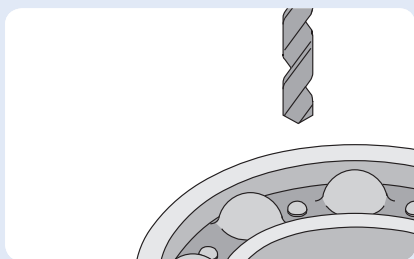

Remove seal and open selected section of ball cage. Clean the swarf out.

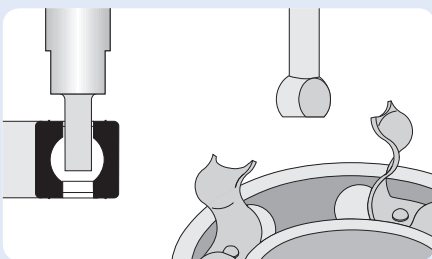

Insert appropriate bearing adapter and rotate it 90° ensuring positive grip within the bearing race.

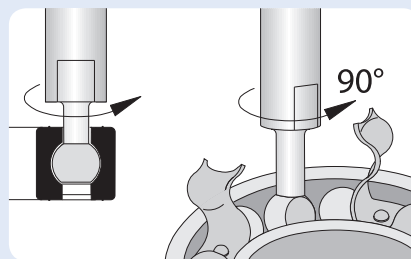

Insert the second adapter into prepared area diametrically opposed.



Easy dismantling of bearings in blind housings

SKF Deep Groove Ball Bearing Puller Kit TMMD 100

The puller is suitable for use in both blind housings and shaft applications. The SKF TMMD 100 is suitable for dismantling up to 71 different SKF deep groove ball bearings, with shaft diameters ranging between 10 and 100 mm (0.4–3.9 in.).

- The claws are designed to precisely fit in the bearing's raceway, providing a good grip, thereby allowing high dismantling forces
- Each puller arm is fitted with a spring for easy installation
- The claw has been designed to allow easy insertion
- The hexagon head of the spindle is designed to prevent the spanner sliding down the spindle during dismantling
- The puller can also be used to remove sealed bearings from blind housings, after the seal has been removed

Suitability chart

The SKF TMMD 100 suits the following bearing series and sizes:

Bearing designation	Shaft diameter	
6000–6020	10–100 mm	(0.4–3.9 in.)
6200–6218	10–90 mm	(0.4–3.5 in.)
6300–6313	10–65 mm	(0.4–2.6 in.)
6403–6410	17–50 mm	(0.7–2.0 in.)
62/22, 62/28, 63/22, 63/28	22, 28, 22, 28 mm	(0.9, 1.1, 0.9, 1.1 in.)
16002, 16003, 16011	15, 17, 55 mm	(0.6, 0.7, 2.2 in.)
16100, 16101	10, 12 mm	(0.4, 0.5 in.)



Bearing selection chart included



The rubber cap allows easy and quick attachment of the arms to the spindle. It also prevents the puller arms from detaching from the spindle during operation



The springs enable easy insertion

Technical data – SKF Blind Housing Puller Kit



Designation	TMBP 20E
Kit contents	6 adapters sizes (2 pcs each), 2 main rods (with nut support rings and nuts) 4 extension rods, Spindle, Spindle nose piece, Beam
Effective arm length	147–547 mm (5.8–21.5 in.)
Maximum pulling force	55 kN (6.2 US ton)
Carrying case dimensions	530 × 85 × 180 mm (20.9 × 3.4 × 7.0 in.)
Weight	6,5 kg (14.3 lb)

Technical data – SKF Deep Groove Ball Bearing Puller Kit



Designation	TMMD 100
Kit contents	3 × puller arm A1–135 mm (5.3 in.) 3 × puller arm A2–135 mm (5.3 in.) 3 × puller arm A3–137 mm (5.4 in.) 3 × puller arm A4–162 mm (6.4 in.) 3 × puller arm A5–167 mm (6.6 in.) 3 × puller arm A6–170 mm (6.7 in.) 2 × spindle and nut, 1 × handle
Effective arm length	135–170 mm (5.3–5.7 in.)
Carrying case dimensions	530 × 85 × 180 mm (20.9 × 3.4 × 7.0 in.)
Weight	3,6 kg (7.9 lb)



Internal pullers

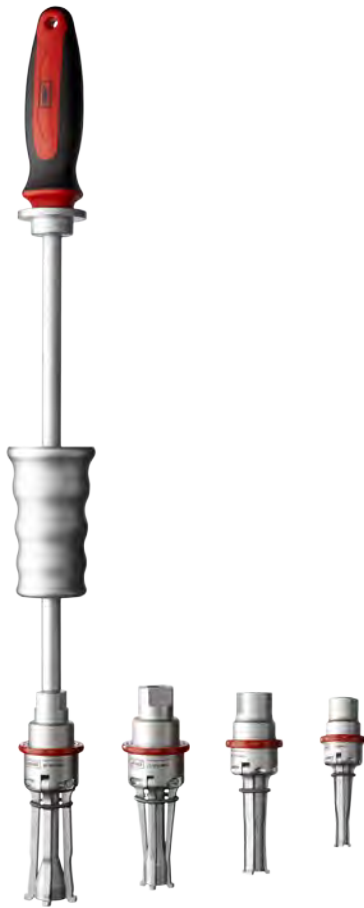

Fast and easy bearing dismounting from housings

SKF Internal Bearing Puller Kits TMIP series

The SKF TMIP kits are specially designed for dismounting bearings from housings where the fit is on the outer ring.

The combination of unique spring-loaded extractors and an ergonomically designed sliding hammer help enable a safe, fast and easy removal of the bearing. Unlike other internal bearing pullers, the extractors can be correctly positioned in just one quick action.

- Unique design saves dismounting time
- Easy removal of bearings from housings
- Designed to suit a wide range of bearing bore diameters; the selection of extractors is easy
- Puller constructed for optimum strength and durability
- Spring loaded extractors allow quick and easy fitting of the extractor to the inner ring
- Claw design provides a strong and secure grip behind the inner ring, allowing a high puller force to be applied
- Ergonomic sliding hammer enhances user safety
- SKF design, patent pending



Technical data – extractors

Extractor size	Bearing bore diameter		Maximum bearing width		Space behind bearing		Housing depth	
	mm	in.	mm	in.	mm	in.	mm	in.
TMIP 7–28								
TMIP E7–9	7–9	0.28–0.35	10	0.39	6	0.24	39	1.5
TMIP E10–12	10–12	0.39–0.47	11	0.43	6	0.24	45	1.8
TMIP E15–17	15–17	0.59–0.67	18	0.71	7,5	0.29	55	2.2
TMIP E20–28	20–28	0.79–1.1	24	0.94	10	0.4	60	2.4
TMIP 30–60								
TMIP E30–40	30–40	1.2–1.6	>35	1.38	11,5	0.45	97	3.8
TMIP E45–60	45–60	1.8–2.4	>64	2.52	15	0.6	102	4.0

Technical data



Designation	TMIP 7–28	TMIP 30–60
Bearing bore diameter	7–28 mm (0.28–1.1 in.)	30–60 mm (1.2–2.4 in.)
Total sliding hammer length	412 mm (16.2 in.)	557 mm (21.9 in.)
Carrying case dimensions	530 × 85 × 180 mm (20.9 × 3.4 × 7.0 in.)	530 × 85 × 180 mm (20.9 × 3.4 × 7.0 in.)
Weight	3.1 kg (6.8 lb)	5.4 kg (11.9 lb)

Puller accessory selection guide

A range of accessories has been developed to further facilitate the ease of use of the SKF puller range.

Puller series

Standard jaw pullers



i 22

Heavy duty jaw pullers



TMMP series
Standard jaw pullers

TMMP series
Heavy duty jaw pullers



i 25

TMMR F series
Reversible jaw pullers



i 20

TMMA series
SKF EasyPull



i 24, 26

TMHC 110E
Hydraulic Puller kit

TMHP 10E
Hydraulic Puller kit

TMBS E series
Strong back pullers



i 23

TMHP series
Hydraulically - assisted heavy duty jaw pullers



i 28, 29

TMMD 100/TMBP 20E
Blind housing puller kits



i 36

**Puller Protection Blankets
TMMX series**



i 34

**Force Generators Advanced
Hydraulic Spindle TMHS series**



i 35

**Tri-section Pulling Plates
TMMS series**

Designation

TMMP 2x65	–	–	–	–
TMMP 2x170	TMMX 280	–	–	–
TMMP 3x185	TMMX 210*	–	–	–
TMMP 3x230	TMMX 210 TMMX 280*	–	–	TMMS 50* TMMS 100
TMMP 3x300	TMMX 280 TMMX 350*	–	–	TMMS 50* TMMS 100 TMMS 50 TMMS 100* TMMS 160
TMMP 6	TMMX 210	–	–	TMMS 50*
TMMP 10	TMMX 280	–	–	TMMS 100*
TMMP 15	TMMX 280 TMMX 350	–	–	TMMS 100* TMMS 160*
TMMR 40F	–	–	–	–
TMMR 60F	–	–	–	–
TMMR 80F	–	–	–	–
TMMR 120F	TMMX 210	–	–	–
TMMR 160F (XL)	TMMX 210 TMMX 280	–	–	–
TMMR 200F (XL)	TMMX 280*	–	–	–
TMMR 250F (XL)	TMMX 350*	–	–	–
TMMR 350F (XL)	–	–	–	–
TMMA 60	TMMX 210*	TMMX 280	–	TMMS 50*
TMMA 80	TMMX 210 TMMX 280*	TMMX 350	TMHS 75	TMMS 50* TMMS 100*
TMMA 120	TMMX 280 TMMX 350*	–	TMHS 100	TMMS 50 TMMS 100* TMMS 160*
TMMA 75H	TMMX 210 TMMX 380*	TMMX 350	TMHS 75 **	TMMS 50* TMMS 100*
TMMA 100H	TMMX 280 TMMX 350*	–	TMHS 100 **	TMMS 50 TMMS 100* TMMS 160*
TMMA 75H/SET	TMMX 280 **	–	TMHS 75 **	TMMS 50* TMMS 100**
TMMA 100H/SET	TMMX 350 **	–	TMHS 100 **	TMMS160 **
TMHC 110E	TMMX 210 TMMX 280*	TMMX 350	TMHS 100 **	–
TMHP 10E	TMMX 210 TMMX 280*	TMMX 350	TMHS 100 **	TMMS 50* TMMS 100* TMMS 160
TMBS 50E	TMMX 210	–	–	–
TMBS 100E	TMMX 210* TMMX 280	–	TMHS 100 **	–
TMBS 150E	TMMX 280* TMMX 350	–	TMHS 100 **	–
TMHP 15/260	–	–	–	TMMS 160 TMMS 260
TMHP 30/170	–	–	–	TMMS 260* TMMS 380
TMHP 30/350	–	–	–	TMMS 260* TMMS 380
TMHP 30/600	–	–	–	TMMS 260* TMMS 380
TMHP 50/140	–	–	–	TMMS 260 TMMS 380*
TMHP 50/320	–	–	–	TMMS 260 TMMS 380*
TMHP 50/570	–	–	–	TMMS 260 TMMS 380*
TMHP 15/260X	–	–	–	TMMS 160 TMMS 260
TMHP 30/170X	–	–	–	TMMS 260* TMMS 380
TMHP 30/350X	–	–	–	TMMS 260* TMMS 380
TMHP 30/600X	–	–	–	TMMS 260* TMMS 380
TMHP 50/140X	–	–	–	TMMS 260 TMMS 380*
TMHP 50/320X	–	–	–	TMMS 260 TMMS 380*
TMHP 50/570X	–	–	–	TMMS 260 TMMS 380*
TMMD 100	TMMX 210*	–	–	–
TMBP 20E	TMMX 210 TMMX 280*	–	–	–

* recommended / ** accessory included with puller



TMHS 75



TMHS 100

Effortless withdrawal force generation

Advanced Hydraulic Spindles TMHS 75 and TMHS 100

The SKF TMHS 75 and TMHS 100 generate a high pulling force with very little effort compared to the standard mechanical spindles. They significantly reduce the time needed to dismount a bearing or other component.

- Integrated hydraulic cylinder, pump and spindle – no separate pump is required
- Safety valve helps prevent overloading the spindle and the puller in case excessive force is applied
- Long stroke helps enable dismounting in one operation
- Spring-loaded nosepiece centre point allows easy puller centring minimising shaft centre point damage
- Hand lever with ergonomic grip can be rotated 360°
- Extension pieces included

TMHS 100 shown as part of hydraulic puller TMMMA 100H



TMHS 75:

- Maximum withdrawal force of 75 kN (8.4 US ton)
- Stroke length of 75 mm (3.0 in.)
- Suitable for use with pullers with a 1 1/4-12 UN thread

TMHS 100:

- Maximum withdrawal force of 100 kN (11.2 US ton)
- Stroke length of 80 mm (3.1 in.)
- Suitable for use with pullers with a 1 1/2-16 UN thread

Technical data

Designation	TMHS 75	TMHS 100
Contents	1 × hydraulic spindle 2 × extension pieces; 50 and 100 mm (2.0 and 3.9 in.) 1 × nosepiece	1 × hydraulic spindle 3 × extension pieces; 50, 100 and 150 mm (2.0, 3.9 and 5.9 in.) 1 × nosepiece
Maximum withdrawal force	75 kN (8.4 US ton)	100 kN (11.2 US ton)
Piston stroke	75 mm (3.0 in.)	80 mm (3.1 in.)
Body thread	1 1/4-12 UN	1 1/2-16 UN
Nose piece diameter	30 mm (1.2 in.)	30 mm (1.2 in.)
Maximum reach	229 mm (9.0 in.)	390 mm (15.4 in.)
Weight	2,7 kg (6.0 lb)	4,5 kg (10.0 lb)



Efficient and correct dismantling

SKF Tri-section Pulling Plates TMMS series

- The SKF TMMS series consists of five different sizes of tri-section pulling plates suitable for shafts with diameters ranging from 50 to 380 mm (2 to 15 in.)
- Suitable for use in combination with three-armed pullers
- The plates grip behind the bearing inner ring, helping to ensure that the pulling forces are only transmitted through the inner ring and not through the outer ring or the rolling elements; thereby minimising the risk of bearing damage
- The tri-section construction allows an even dismantling force distribution, preventing bearing locking and/or tilting on the shaft, especially in the case of spherical roller and CARB toroidal roller bearings
- Special wedge shape design allows the plates to be easily inserted between the bearing and the shoulder on the shaft

Dimensions

Designation	d_{\min}		d_{\max}		A		H	
	mm	in.	mm	in.	mm	in.	mm	in.
TMMS 50	12	0.5	50	2.0	20–30	0.8–1.2	15	0.6
TMMS 100	26	1.0	100	3.9	30–55	1.4–2.2	25	1.0
TMMS 160	50	2.0	160	6.3	45–73	1.8–2.9	30	1.2
TMMS 260	90	3.6	260	10.2	70–114	2.8–4.5	42	1.7
TMMS 380	140	5.5	380	15.0	81–142	3.2–5.6	58	2.3

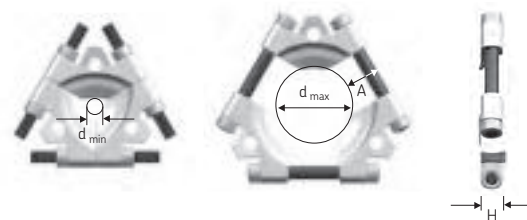

TMMS 160 shown as part of hydraulic puller set TMMA 100H/SET



For additional user safety during dismounting

SKF Puller Protection Blankets TMMX series

- The SKF TMMX series are designed to offer additional user safety, while dismounting bearings or other components
- After the puller has been positioned, the blanket is simply wrapped around the puller and application
- The tough, transparent plastic allows the user to monitor the component and the puller during operation
- Especially designed to fit SKF TMM series pullers, they are also suitable for use in combination with many other pullers

Dimensions

Designation	Recommended maximum diameter		Length		Width	
	mm	in.	mm	in.	mm	in.
TMMX 210	210	8.3	750	29.5	420	16.5
TMMX 280	280	11.0	970	38.2	480	18.9
TMMX 350	350	13.8	1 200	47.2	580	22.8



SKF Anti-fretting Agent LGAF 3E

SKF LGAF 3E is a greasy, smooth paste to prevent fretting corrosion caused by very slight oscillations or by vibrations, that can make dismounting much more difficult.

- Suitable for bearings and metal surfaces in loose fit arrangements, such as vibrating screens, truck and car wheel bearings
- Reduces fretting corrosion thereby enabling easier dismounting of bearings
- Assists with easier removal of general industrial components in a wide range of applications such as nuts, bolts, flanges, studs, bearings, guide pins, couplings, jack screws, lathe centres, push rods, and spline shafts



Technical data

Designation	LGAF 3E/0.5
Specific gravity	1,19
Colour	White-beige
Base oil type	Mineral and synthetic
Thickener	Lithium soap
Operating temperature range	-25 to +150 °C (-13 to +302 °F)
Base oil viscosity: 40 °C, mm ² /s	17,5
Available pack sizes	0,5 kg can



SKF Anti Corrosive Agent LHRP 2

SKF LHRP 2 provides excellent long-term corrosion protection to ferrous and non-ferrous surfaces. When applied, it creates a stable rust protection film on the surface of the metal.

- Effective rust protection, even in high humidity environments
- The thixotropic, non dripping, nature creates a stable protective film
- The residual films can be easily cleaned by slight mechanical agitation or heat
- Does not adhere to most packaging papers
- Most bearings do not need to be cleaned before applying SKF grease*

* Note: Film needs to be removed before applying SKF LGET 2 grease.



Technical data

Designation	LHRP 2/5
Specific gravity	0,835
Colour	Hazy brown
Base oil type	Mineral
Flash point	>62 °C (>144 °F)
Pour point	<4 °C (<39 °F)
Available pack sizes	5 l can



Provides protection and excellent grip

SKF Special Working Gloves TMBA G11W

The SKF TMBA G11W gloves are designed for general-purpose industrial maintenance work. The palms are coated with non-flammable dots providing excellent grip.

- Tear resistant
- Flexible and comfortable
- Lint free
- Non allergenic
- Tested and certified according to EN 388 (mechanical risks)

Technical data

Designation	TMBA G11W
Size	9
Colour	White/blue
Pack size	1 pair

Heating tools

Mounting

Remote control makes the heater easy and safe to use

Magnetic temperature probe, on the inner ring, helps prevent bearing overheating



Foldable bearing support arms allow larger diameter bearings to be heated

It's a fact.

Incorrect mounting methods account for up to 16% of premature bearing failures

To reduce the risk of incorrect mounting, SKF helped pioneer the use of portable induction heaters for bearing mounting applications in the 1970's. Since that time, there have been many advances in technology and SKF has been at the forefront in developing safer, more efficient and user-friendly bearing induction heaters.

SKF induction heaters are probably the best performing heaters available. Their unique design typically consumes just 50% of the electrical power needed by most competitors' bearing induction heaters to heat a bearing.

As a result, by using an SKF induction heater, the total cost of ownership is often significantly lower. Ergonomics and safety are also an important consideration for operators. SKF induction heaters are equipped with design features that make them easy to use and safe. Bearing support arms reduce the risk of the bearing toppling during heating, and ergonomically designed yokes help reduce operator fatigue. In addition, the unique remote control enables the operator to control the heater at a safe distance from the hot bearing, enhancing operator safety.

Features and benefits

The comprehensive SKF induction heater range can be used for efficiently heating bearings and workpieces, both large and small. Their innovative design offers significant advantages to both owners and operators:

- Advanced power electronics, with accurate electric current control, helps control the temperature rate increase
 - Two step power setting option (50% / 100%), enables small bearings to be heated safely and at a lower power consumption
 - For heating components other than bearings, all heaters are equipped with a heating time mode
 - Thermal overheating protection reduces the risk of damage to the induction coil and the electronics, enhancing reliability and safety
 - Automatic demagnetisation reduces the risk of ferrous debris contamination after heating
 - Available in different voltage variants, to suit most operating voltages worldwide
 - Supplied with heat-resistant gloves for improved operator safety
 - Comprehensive 3 year warranty
- A** Induction coil located outside the heater's housing enables a shorter heating time and lower energy consumption
 - B** Foldable bearing support arms allow larger diameter bearings to be heated, and reduce the risk of the bearing toppling during heating
 - C** Magnetic temperature probe, combined with a temperature mode pre-set at 110 °C (230 °F), helps prevent bearing overheating
 - D** Unique SKF remote control, with operating display and control panel, makes the heater easy and safe to use
 - E** Internal yoke storage, for smaller yoke(s), reduces the risk of yoke damage or loss
 - F** Integrated carrying handles allow for easy movement of the heater in the workshop
 - G** Sliding or swivel arm allows for easy and quick bearing replacement, reducing operator fatigue (not for TIH 030m)

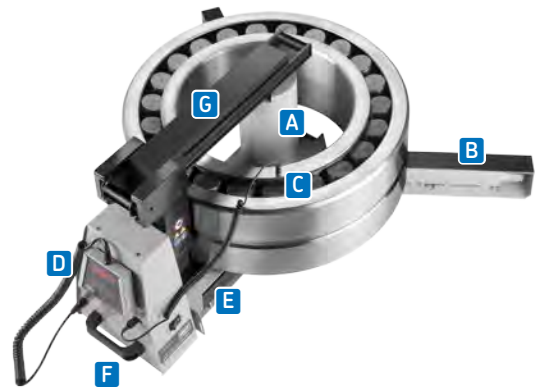

Induction heating has many advantages over other bearing heating methods

The use of an open flame to heat a bearing is not only inefficient and uncontrolled, but often leads to bearing damage. This method should not be used.

Oil baths are sometimes used to heat bearings. Oil baths often take a long time to reach the required temperature and can be difficult to control the actual bearing temperature. The energy consumption of an oil bath is also significantly greater than using an induction heater. The risk of contaminating the bearing due to dirty oil is significant and can lead to premature bearing failure. Handling hot, oily and slippery bearings present significant hazards to the operator and great care must be taken to avoid potential injuries.

Ovens and hot plates are often used for batch heating of small bearings and this is an acceptable technique. However, for larger bearings, the use of ovens and hotplates is generally quite inefficient and time consuming and can present the operator with significant handling hazards.

Induction heaters are the modern, efficient and safe way to heat bearings. In operation, they are generally faster, cleaner, more controllable, and easier to use than other heating methods.

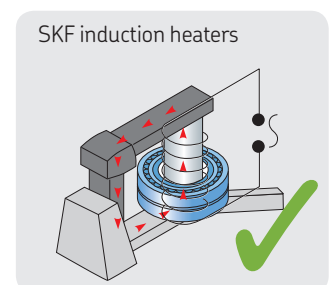
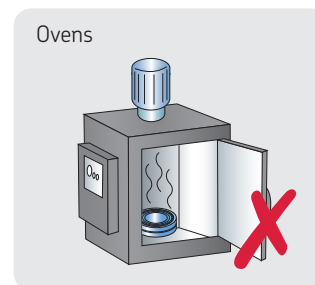
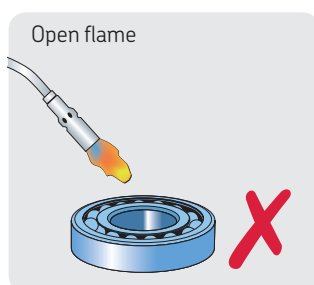

Induction heaters



TMBH 1

Portable induction heater weighing only 4,5 kg

- Portable, lightweight, high efficiency heater for bearings with an inner diameter ranging from 20 to 100 mm (0.8 to 4 in.), and a maximum weight of 5 kg (11 lb)
- Equipped with temperature and time control and automatic demagnetisation
- Supplied in a carrying case
- Wide operating voltage: 100–240 V/50–60 Hz



TIH 030m

Small induction heater with a 40 kg bearing heating capacity

- Compact lightweight design; just 21 kg (46 lb), facilitating portability
- Capable of heating a 28 kg (62 lb) bearing in just 20 minutes
- Supplied standard with three yokes, allowing bearings with a bore diameter from 20 mm (0.8 in.) up to a maximum weight of 40 kg (90 lb) to be heated
- Available in two versions: 230 V/50–60 Hz and 100–110 V/50–60 Hz



TIH 100m

Medium induction heater with a 120 kg bearing heating capacity

- Capable of heating a 97 kg (213 lb) bearing in less than 20 minutes
- Supplied standard with three yokes, allowing bearings with a bore diameter from 20 mm (0.8 in.) up to a maximum weight of 120 kg (264 lb) to be heated
- Swivel arm for large size yoke
- Available in two versions: 230 V/50–60 Hz and 400–460 V/50–60 Hz

SKF induction heater range

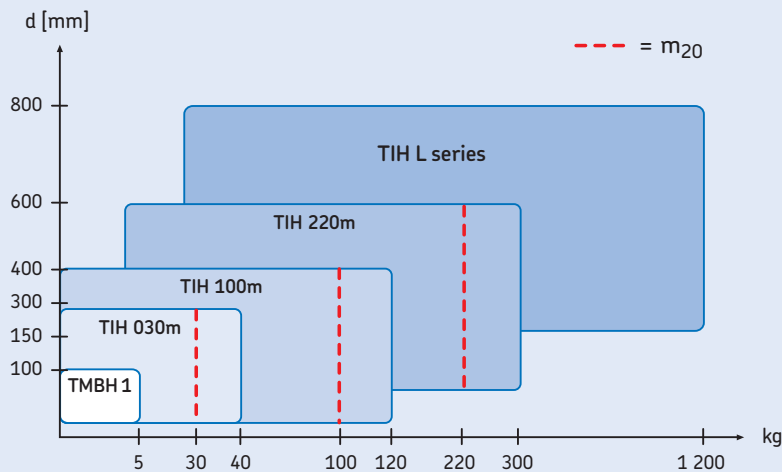

The comprehensive range of SKF induction heaters is suitable for most bearing heating applications. The chart gives general information on choosing an induction heater for bearing heating applications.*

The SKF m_{20} concept represents the weight (kg) of the heaviest SKF spherical roller bearing of series 231 which can be heated from 20 to 110 °C (68 to 230 °F) in 20 minutes. This defines the heater's power output instead of its power consumption. Unlike other bearing heaters, there is a clear indication on how long it takes to heat a bearing, rather than just the maximum bearing weight possible.

* For heating components other than bearings, we strongly recommend that you contact SKF to help you select a suitable induction heater for your application.



TIH 220m

Large induction heater with a 300 kg bearing heating capacity

- Capable of heating a 220 kg (480 lb) bearing in just 20 minutes
- Supplied standard with two yokes, allowing bearings with a bore diameter from 60 mm (2.3 in.) up to a maximum weight of 300 kg (660 lb) to be heated
- Sliding arm for large size yoke
- Available in two versions: 230 V/50–60 Hz and 400–460 V/50–60 Hz



TIH L series

Extra large induction heater with a 1 200 kg bearing heating capacity

- Using just 20 kVA of electrical power, the TIH L series can heat large bearings up to 1 200 kg (2 600 lb)
- Bearings and work pieces can be heated vertically or horizontally
- Compact design allows the TIH L series heaters to be easily transported by forklift
- Available in two versions: 230 V/50–60 Hz and 400–460 V/50–60 Hz
- Available with two different operating areas



Foldable bearing support arms



Technical data



Designation	TMBH 1	TIH 030m	TIH 100m	TIH 220m	TIH L44 TIH L77
Max. workpiece weight	5 kg (11 lb)	40 kg (88 lb)	120 kg (264 lb)	300 kg (662 lb)	1 200 kg (2 600 lb)
Bore diameter range	20–100 mm (0.8–4 in.)	20–300 mm (0.8–11.8 in.)	20–400 mm (0.8–15.7 in.)	60–600 mm (2.3–23.6 in.)	150–800 mm (5.9–31.5 in.)
Operating area (w × h)	52 × 52 mm (2 × 2 in.)	100 × 135 mm (3.9 × 5.3 in.)	155 × 205 mm (6.1 × 8 in.)	250 × 255 mm (9.8 × 10 in.)	TIH L44: 425 × 492 mm (16.7 × 19.4 in.) TIH L77: 725 × 792 mm (28.4 × 31.2 in.)
Coil diameter	N/A	95 mm (3.7 in.)	110 mm (4.3 in.)	140 mm (5.5 in.)	175 mm (6.8 in.)
Standard yokes (included) to suit bearing/workpiece minimum bore diameter	20 mm (0.8 in.)	65 mm (2.6 in.) 40 mm (1.6 in.) 20 mm (0.8 in.)	80 mm (3.1 in.) 40 mm (1.6 in.) 20 mm (0.8 in.)	100 mm (3.9 in.) 60 mm (2.3 in.)	150 mm (5.9 in.)
SKF m ₂₀ * performance	N/A	28 kg (61.7 lb)	97 kg (213 lb)	220 kg (480 lb)	N/A
Max. power consumption	350 Watt	2,0 kVA	3,6 kVA (230 V) 4,0–4,6 kVA (400–460 V)	10,0–11,5 kVA (400–460 V)	20–24 kVA (200–240 V)
Voltage**					
100–240 V/50–60 Hz	TMBH 1	–	–	–	–
100–120 V/50–60 Hz	–	TIH 030m/110 V	–	–	–
200–240 V/50–60 Hz	–	TIH 030m/230 V	TIH 100m/230 V	TIH 220m/LV	TIH L./LV
400–460 V/50–60 Hz	–	–	TIH 100m/MV	TIH 220m/MV	TIH L./MV
Temperature control	0 to 200 °C (32 to 392 °F)	20 to 250 °C (68 to 482 °F)	20 to 250 °C (68 to 482 °F)	20 to 250 °C (68 to 482 °F)	20 to 250 °C (68 to 482 °F)
Time control (minutes)	0–60	0–60	0–60	0–60	0–120
Demagnetisation according to SKF norms	N/A	<2 A/cm	<2 A/cm	<2 A/cm	<2 A/cm
Max. temperature	200 °C (392 °F)	400 °C (750 °F)	400 °C (750 °F)	400 °C (750 °F)	400 °C (750 °F)
Dimensions (w × d × h)	330 × 150 × 150 mm (13 × 5.9 × 5.9 in.) Clamp: 115 × 115 × 31 mm (4.5 × 4.5 × 1.2 in.)	460 × 200 × 260 mm (18.1 × 7.9 × 10.2 in.)	570 × 230 × 350 mm (22.4 × 9 × 13.7 in.)	750 × 290 × 440 mm (29.5 × 11.4 × 17.3 in.)	TIH L44: 1 200 × 600 × 850 mm (47.3 × 23.6 × 33.5 in.) TIH L77: 1 320 × 600 × 1 150 mm (52 × 23.6 × 45.3 in.)
Total weight (incl. yokes)	4,5 kg (10 lb)	20,9 kg (46 lb)	42 kg (92 lb)	86 kg (189 lb)	TIH L44: 324 kg (714 lb) TIH L77: 415 kg (915 lb)

* SKF m₂₀ performance represents the weight (kg) of the heaviest SKF spherical roller bearing of series 231, which can be heated from 20 to 110 °C (68 to 230 °F) in 20 minutes.

** Some special voltage versions are available for specific countries. For additional information, contact your SKF authorized distributor.



A unique and flexible heating solution for very large bearings and workpieces

Multi-core induction heaters, TIH MC series

The SKF multi-core induction heaters are energy efficient, custom-made heating solutions. Compared to other heating methods, they often can significantly save heating time.

The TIH MC series are similar to the standard TIH range, with a few key differences and additional features:

- Flexible design, consisting of a number of induction heating cores and coils controlled by a single control and power cabinet
- Suitable for heating large thin section workpieces, such as slewing rings and railway wheel tyres
- Heating capacities of several tonnes are possible, depending on application
- Enables a more even temperature gradient across the whole circumference. This is especially important for components sensitive to uneven induction heating
- Unique design allows for custom-made solutions to be quickly and economically produced
- SKF can configure the type of TIH MC series heater required, depending on the application. For additional information, contact your SKF authorized distributor



Thermostat controlled bearing heating

SKF Electric Hot Plate 729659 C

The SKF 729659 C is a heating device especially designed for pre-heating batches of small bearings prior to mounting.

The temperature of the plate can be adjusted to provide temperatures between 50 and 200 °C (120 and 390 °F). The flat heating surface ensures even bearing heating and the cover helps retain heat and keep contaminants out.

Technical data

Designation **729659 C**
729659 C/110V

Voltage 729659 C 230 V (50/60 Hz)
729659 C/110V 115 V (50/60 Hz)

Power 1 000 W

Temperature range 50–200 °C (120–390 °F)

Plate dimensions (l × w) 380 × 178 mm (15 × 7 in.)

Height of cover 50 mm (2 in.)

Overall dimensions (l × w × h) 390 × 240 × 140 mm
(15.4 × 9.5 × 5.5 in.)

Weight 4,7 kg (10 lb)

Dismounting

SKF's range of heating equipment enables quick and safe dismounting of cylindrical roller bearing inner rings and covers a wide range of applications. Aluminium heating rings TMBR series are designed for dismounting inner rings of small and medium-size cylindrical roller bearings. Adjustable and fixed induction heaters EAZ series are suitable for frequent dismounting of various sizes of cylindrical roller bearing inner rings.



For regular dismounting of cylindrical roller bearings

SKF Aluminium Heating Rings TMBR series

The aluminium heating rings are designed for dismounting inner rings of cylindrical roller bearings.

They are available for all bearing sizes of the NU, NJ and NUP series. These series are bearings without flanges or with only one flange on the inner ring. The rings are available as standard for the following bearing sizes: 204 to 252, 304 to 340, 406 to 430.

- Simple and easy-to-use
- Avoids shaft and bearing inner ring damage

Technical data

Designation	TMBR Bearing designation; (e.g. TMBR NU216E)
Material	Aluminium
Maximum temperature	300 °C (572 °F)

Cylindrical roller bearings are essential machine components for applications in steel, railway and other industries. In many cases cylindrical roller bearings experience harsh operating conditions and need to be replaced frequently. Fixed size EAZ heaters and corresponding control cabinets are one SKF dismounting solution that supports fast, easy and safe dismounting of cylindrical roller bearing inner rings and similar components.



Fixed size EAZ heaters are customised SKF Induction Heaters for dismounting cylindrical roller bearing inner rings. Please contact SKF to assist you in finding an EAZ heater that suits your application. EAZ heaters are supplied without a control cabinet. SKF control cabinets are required to operate the fixed size EAZ heater and can be ordered separately.



Safe and easy bearing removal in just 3 minutes

SKF Fixed Induction Heater EAZ series

The fixed size EAZ induction heaters are designed to safely and easily dismount cylindrical roller bearing inner rings, which are often mounted with a very tight interference fit.

Heating the inner ring rapidly loosens the fit, as the shaft remains cool, enabling the ring to be removed without causing damage to the shaft or inner ring. With easy-to-use fixed size EAZ induction heaters, three minutes are usually enough time to professionally dismount cylindrical roller bearing inner rings or similar components.

- Control cabinets from SKF provide the necessary power to run fixed size EAZ heaters and are available with various voltages to operate EAZ heaters in almost any country. Special versions of the control cabinets are available that enable up to three EAZ heaters to be used simultaneously.
- In light section mills, rod wire mills or railway applications, EAZ heaters can often dismount cylindrical roller bearing inner rings with one or more rows of rollers or multiple inner rings at the same time.
- EAZ induction heaters can also be used to dismount non-bearing elements like sleeves or rings.



Control cabinet

Examples of EAZ heater designations

Designation	Inner ring dimension (mm)			interference fit
	F	B	d	
EAZ F179	179	168	145	p6
EAZ F180	180	130	160	p6
EAZ F202	202	168	180	p6
EAZ F222-1	222	170	200	p6
EAZ F222	222	200	200	p6
EAZ F226	226	192	200	p6
EAZ F260	260	206	230	r6
EAZ F312	312	220	280	r6
EAZ F332	332	300	300	r6
EAZ F364	364	240	320	p6

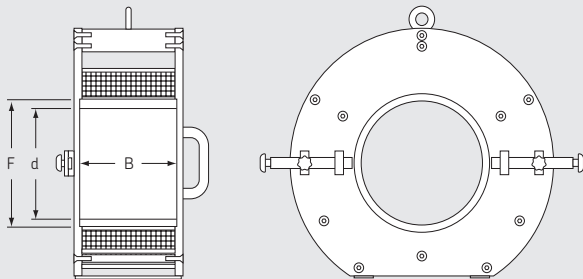

Please, add corresponding F dimension as a suffix to the designation when ordering (e.g. EAZ F312MV).

Voltage classification

LV	Low voltage	190 to 230 V
MV	Medium voltage	400 to 480 V
HV	High voltage	500 to 575 V
HVC	High voltage, CSA ready	575 V

Add corresponding class as a suffix to the designation when ordering (e.g. EAZ F312MV).

Control cabinet versions

SS	1x fixed EAZ	max. 250 A
SSD	2x fixed EAZ	max. 350 A
SST	3x fixed EAZ	

Add corresponding cabinet version to the designation when ordering (e.g. SSD C350B).

Control cabinet base voltage and frequency code

A	230 V	50 Hz
B	400 V	50 Hz
C	460 V	60 Hz
E	575 V	60 Hz

Add corresponding control cabinet voltage and frequency code as a suffix to the designation when ordering (e.g. SSD C350B).



For frequent dismounting of cylindrical roller bearings

SKF Adjustable Induction Heaters EAZ series

The SKF EAZ 80/130 and EAZ 130/170 are used for frequent dismounting of cylindrical bearing inner rings. Where inner rings are removed infrequently, aluminium heating rings, SKF TMBR series, are also available. For larger cylindrical inner rings normally found in steel mill applications, SKF can supply special EAZ induction heaters.

- Covers most cylindrical bearings 65 to 130 mm (2.5 to 5.1 in.) bore diameter
- Wide range of power supplies
- 1 year warranty
- Avoids shaft and bearing inner ring damage
- Fast and reliable bearing removal
- Up to n6 interference fit

Bearing selection chart (All E-types bearings included)

Designation	For bearings NJ-NUP					
EAZ 80/130	213–220	313–319	412–417	1014–1022	2213–2220	2313–2319
EAZ 130/170	222–228	321–324	419–422	1024–1030	2222–2228	2322–2324
Designation	For bearings NU					
EAZ 80/130	213–221	313–320	412–418	1014–1022	2213–2220	2313–2320
EAZ 130/170	222–228	321–326	419–424	1024–1030	2222–2228	2322–2326

Ordering designations

Designation	Power supply	Current	Designation	Power supply	Current
EAZ 80/130A	2 × 230 V/50 Hz	40 A	EAZ 130/170D	3 × 230 V/50 Hz	43 A
EAZ 80/130B	2 × 400 V/50 Hz	45 A	EAZ 130/170E	3 × 400 V/50 Hz	35 A
EAZ 80/130C	2 × 460 V/60 Hz	25 A	EAZ 130/170F	3 × 460 V/60 Hz	23 A
EAZ 80/130D	2 × 415 V/50 Hz	35 A	EAZ 130/170G	3 × 420 V/60 Hz	30 A
EAZ 130/170A	2 × 230 V/50 Hz	60 A	EAZ 130/170H	3 × 415 V/50 Hz	30 A
EAZ 130/170B	2 × 400 V/50 Hz	45 A			

Dimensions

Designation	EAZ 80/130		EAZ 130/170	
Connection cable	5 m (16 ft)		5 m (16 ft)	
Dimensions	a	134 mm (5.3 in.)	180 mm (7.1 in.)	
	b	50 mm (2.0 in.)	50 mm (2.0 in.)	
	c	80 ... 132 mm (3.1 ... 5.2 in.)	130 ... 172 mm (5.1 ... 6.8 in.)	
Weight	28 kg (62 lb)		35 kg (77 lb)	

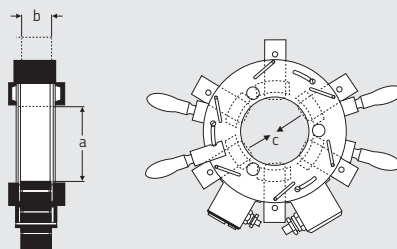

Accessories



Technical data

Designation	TMBA G11
Material	Hytex
Inner lining	Cotton
Size	9
Colour	White
Maximum temperature	150 °C (302 °F)
Pack size	1 pair

For safe handling of heated components up to 150 °C (302 °F)

SKF Heat Resistant Gloves TMBA G11

The SKF TMBA G11 are specially designed for the handling of heated bearings.

- Lint free
- Heat resistant up to 150 °C (302 °F)
- Cut resistant
- Tested and certified for mechanical risks (EN 388) and thermal risks (EN 407)



Technical data

Designation	TMBA G11ET
Material	Kevlar
Inner lining	Cotton
Size	10 (EN 420 size)
Colour	Yellow
Maximum temperature	500 °C (932 °F)
Pack size	1 pair

For safe handling of heated components up to 500 °C (932 °F)

SKF Extreme Temperature Gloves TMBA G11ET

The SKF TMBA G11ET are especially designed for the safe handling of heated bearings or other components for prolonged periods.

- Withstands extreme temperatures of up to 500 °C (932 °F) unless in the presence of hot liquid or steam
- Allows the safe handling of heated components
- High-degree of non-flammability reduces the risk of burning
- Extremely tough Kevlar gloves with high cut, abrasion, puncture and tear resistance for increased safety
- Lint free
- Tested and certified for mechanical risks (EN 388) and thermal risks (EN 407)



Technical data

Designation	TMBA G11H
Material	Polyaramid
Inner lining	Nitrile
Size	10
Colour	Black
Maximum temperature	250 °C (482 °F)
Pack size	1 pair

For safe handling of oily and heated components up to 250 °C (482 °F)

SKF Heat and Oil Resistant Gloves TMBA G11H

The SKF TMBA G11H are specially designed for the handling of hot and oily bearings.

- Offers a high degree of heat, cut, oil and water resistance
- Melt and burn resistant
- Maximum temperature: 250 °C (482 °F)
- Cut resistant
- Lint free
- Suitable for submerging in liquids with a temperature up to 120 °C (248 °F) (e.g. hot oil bath)
- Remains heat resistant when wet
- Tested and certified for mechanical risks (EN 388) and thermal risks (EN 407)

Mounting and dismounting bearings using hydraulic techniques

SKF invented hydraulic techniques for mounting bearings in the 1940s. Since then, the SKF hydraulic methods have been further developed to become the preferred mounting methods for larger bearings as well as other components.

These techniques have helped to simplify bearing arrangements and facilitate correct and easy mounting. Using SKF hydraulic techniques for bearing dismounting reduces the risk of damaging the bearing or its seating. Additionally, greater withdrawal forces can be applied with less effort and maximum control, allowing quick and safe dismounting.

With the SKF hydraulic mounting and dismounting techniques, you can achieve:

- More control, allowing precision, accuracy and repeatability to be maintained
- Minimum risk of damaging the bearings and shafts
- Less manual effort
- Greater operator safety

Makes bearing mounting an easy task

SKF Oil Injection Method

The SKF Oil Injection Method allows bearings and other components with an interference fit to be fitted in a safe, controllable and rapid manner. The method does not require keyways to be machined on the shaft, saving valuable time and money in materials and production. Interference fits (also known as shrink fits) have long been recognised for their reliability in transmitting large torsional loads. Very often, interference fits offer the only solution when connecting hubs to shafts with intermittent or fluctuating loads.

Easy, quick and effortless bearing dismounting

When using the SKF Oil Injection Method, the mating surfaces are separated by a thin film of oil injected under high pressure, thereby virtually eliminating the friction between them. The method is versatile as it can be used for dismounting bearings and other components mounted on either cylindrical or tapered seatings. When dismounting bearings mounted on cylindrical seatings, the injected oil can reduce the required pulling forces by up to 90%. Subsequently, the physical effort required when using a puller to remove the bearing from its seating is significantly reduced.

When using the SKF Oil Injection Method to dismount bearings mounted on tapered seatings, the interference fit is completely overcome by the injected oil. The bearing is then ejected from the seating with great force, making the use of a puller unnecessary. In this case, a stop-nut must be used to control the ejection of the bearing. The SKF Oil Injection Method, which is used for many bearing applications, can also be used in other applications, such as:

- Couplings
- Gear wheels
- Railway wheels
- Propellers
- Built-up crankshafts

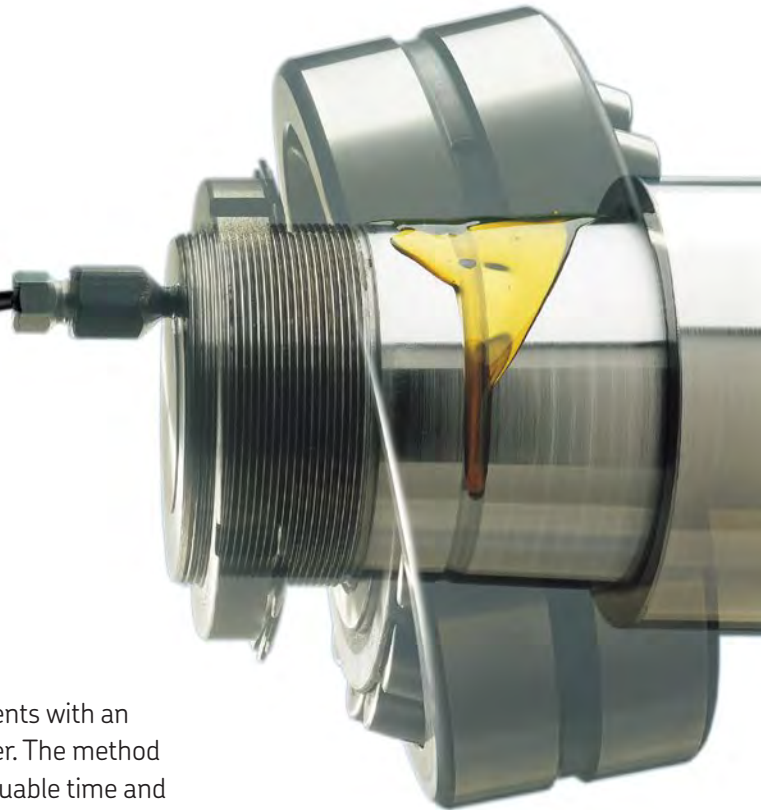

Mounting

Tapered shafts

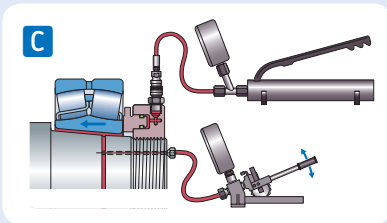
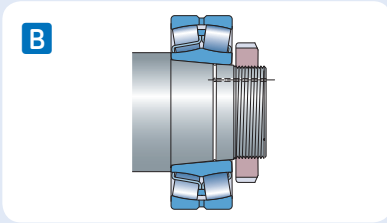
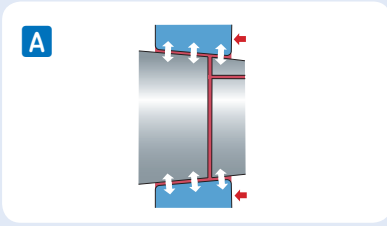

A The concept

Injecting oil between two tapered surfaces creates a thin oil film, which reduces the friction between them, thereby significantly reducing the mounting force required. The thin oil film also minimises the risk of metallic contact when mounting, reducing the risk of component damage.

B The preparation

During manufacture, the shafts are prepared with oil ducts and grooves. For technical information on how to prepare the shafts, consult an SKF application engineer.

C The action

Bearings are mounted by pushing them up the shaft with the aid of an SKF HMV .. E nut. The force to mount the bearing is reduced if oil is injected between the shaft and the bearing. This is often done with larger size bearings.

Dismounting

Cylindrical shafts

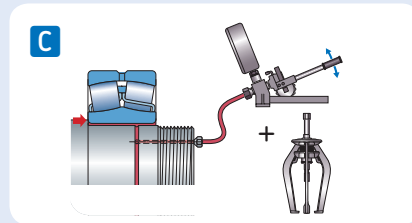
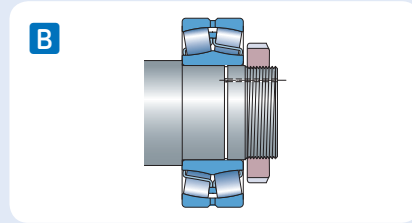
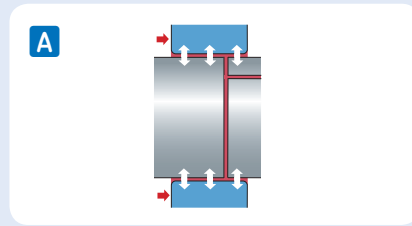

A The concept

By injecting oil of a certain viscosity between two shrink fitted surfaces, the mating surfaces will become separated by a thin oil film. The dismounting force required is thus greatly reduced. The thin oil film also minimises the risk of metallic contact when dismounting, reducing the risk of component damage.

B The preparation

During manufacture, the shafts are prepared with oil ducts and grooves. For technical information on how to prepare the shafts, consult an SKF application engineer.

C The action

Dismounting the bearing is made easier by pumping oil under pressure between the mating surfaces. Once the oil pressure has built up, the component can be removed from the shaft with a minimum of effort.

Tapered shafts

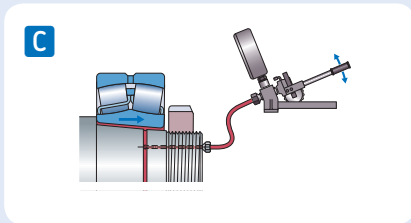
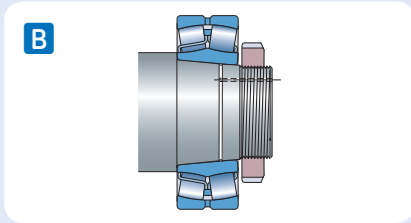
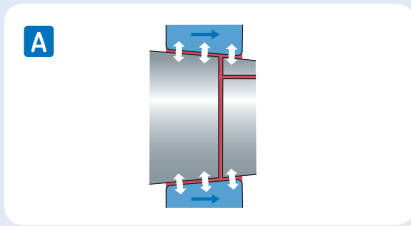

A The concept

Injecting the oil between two tapered surfaces will create a reaction force which could be quite substantial as the oil will also act as a "hydraulic cylinder" which can push the outer component off.

B The preparation

During manufacture, the shafts are prepared with oil ducts and grooves. For technical information on how to prepare the shafts, consult an SKF application engineer.

C The action

Bearings are dismounted by injecting oil between the mating surfaces and when sufficient pressure is reached, the bearing will be pushed off. A nut is required to keep the bearing from sliding off the shaft.

SKF Drive-up Method



Accurate axial drive-up of spherical roller and CARB toroidal roller bearings

The SKF Drive-up Method is a well-proven method, unique to SKF, of accurately achieving the adjustment of spherical roller and CARB toroidal roller bearings mounted on tapered seatings. The correct fit is achieved by controlling the axial drive-up of the bearing from a predetermined position. The method incorporates the use of an SKF HMV ..E hydraulic nut fitted with a dial indicator, and a high accuracy digital pressure gauge, mounted on the selected pump. Special hydraulic pressure tables have been developed, providing the required pressures, for each bearing type. This enables accurate positioning of the bearing at the starting point from where the axial drive-up is measured.

- Reduces the use of feeler gauges
- Greatly reduces the time to mount spherical roller and CARB toroidal roller bearings
- A reliable and accurate method of adjustment
- The only suitable way to mount sealed spherical roller and CARB bearings

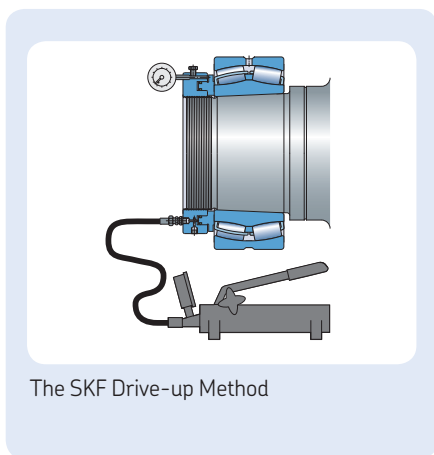

Products for the SKF Drive-up Method

Designation	Description
HMV ..E (e.g. HMV 54E)	Metric thread hydraulic nut
HMVC ..E (e.g. HMVC 54E)	Inch thread hydraulic nut
HMV ..E/A101 (e.g. HMV 54E/A101)	Unthreaded hydraulic nut
729124 DU (for nuts ≤ HMV 54E)	Pump with digital gauge (MPa/psi)
TMJL 100DU (for nuts ≤ HMV 92E)	Pump with digital gauge (MPa/psi)
TMJL 50DU (all sizes HMV ..E nuts)	Pump with digital gauge (MPa/psi)
THGD 100	Digital gauge only (MPa/psi)
TMCD 10R	Horizontal dial indicator (0–10 mm)
TMCD 5P	Vertical dial indicator (0–5 mm)
TMCD 1/2R	Horizontal dial indicator (0–0.5 in.)

Technical data – Hydraulic pumps

Designation	729124 DU	TMJL 100DU	TMJL 50DU
Max. pressure	100 MPa (14 500 psi)	100 MPa (14 500 psi)	50 MPa (7 250 psi)
Volume/stroke	0,5 cm ³ (0.03 in. ³)	1,0 cm ³ (0.06 in. ³)	3,5 cm ³ (0.21 in. ³)
Oil container capacity	250 cm ³ (15 in. ³)	800 cm ³ (48 in. ³)	2 700 cm ³ (165 in. ³)
Digital pressure gauge unit	MPa/psi	MPa/psi	MPa/psi

Note: All above pumps are supplied complete with digital pressure gauge, high pressure hose and quick connect coupling.

Step by step procedure

One sliding surface

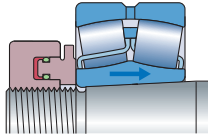

One sliding surface

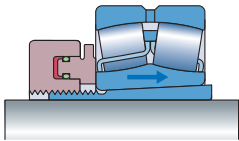

Two sliding surfaces

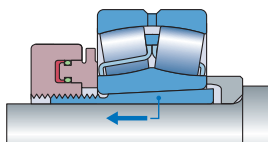

Two sliding surfaces

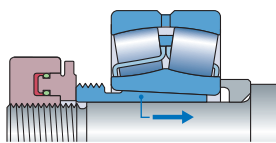

1. Determine whether one or two surfaces slide during mounting; see figures.
2. Lightly oil all mating surfaces with a thin oil, e.g. SKF LHM 300, and carefully place the bearing on the shaft.
3. Drive the bearing up to the starting position by applying the required hydraulic nut pressure. Monitor the pressure using the gauge on the selected pump. SKF Hydraulic Pump 729124 DU is suitable for SKF Hydraulic Nuts \leq HMV 54E. SKF TMJL 100DU is suitable for SKF Hydraulic Nuts \leq HMV 92E while SKF TMJL 50DU is suitable for nuts \leq HMV 200E. As an alternative, the digital pressure gauge THGD 100 can be screwed directly into the hydraulic nut.
4. Drive the bearing up the taper by the required distance S_s . The axial drive-up is best monitored by a dial indicator. The SKF Hydraulic Nut HMV ..E is prepared for dial indicators. Normally, the bearing is now mounted with a suitable interference on the shaft and a suitable residual clearance.

The required hydraulic nut pressure and axial drive-up value, for many operating conditions, can be found at skf.com/mount.

- A₁ Zero position
- A₂ Starting position
- A₃ Final position

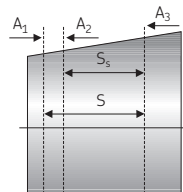

Patent protected



For use with previous generation of SKF HMV(C) hydraulic nuts

SKF Hydraulic Nut Drive-up Adapter HMVA 42/200

The SKF Drive-up Method is the preferred method for mounting SKF spherical roller and CARB toroidal roller bearings on tapered seatings. An adapter, used in conjunction with an SKF Dial Indicator, the adapter allows the previous generation of SKF HMV nuts to be used with the SKF Drive-up Method.

The adapter can be used with nuts from size SKF HMV(C) 42 to HMV(C) 200. The adapter is not required for the current generation of SKF HMV(C) ..E nuts.

- One adapter suits the previous generation nuts from SKF HMV(C) 42 up to 200
- Rugged construction
- Easy to attach to the SKF HMV nut using strong magnets
- Used in conjunction with SKF dial indicators

Hydraulic nuts



Easy application of high drive-up forces

Hydraulic Nuts HMV ..E series

Mounting bearings on tapered seatings can be a difficult and time-consuming job. Using an SKF Hydraulic Nut facilitates easy and quick application of the high drive-up forces required for mounting bearings. Dismounting bearings mounted on either adapter or withdrawal sleeves is also often a difficult and time-consuming job. These problems can be reduced with the use of an SKF Hydraulic Nut. Oil is pumped into the nut and the piston is pushed out with a force, which is sufficient to free the sleeve. All SKF HMV ..E nuts are supplied with a quick connection coupling to fit the SKF hydraulic pumps.

- Wide size range, covering shaft diameters from 50 to 1 000 mm as standard
- Full range of inch threads available, series HMVC ..E from 1.967 up to 37.410 in.
- Quick connection coupling can be fitted on the face or side of the nut, allowing the nut to be used in areas where space is limited
- A spare set of piston seals and maintenance kit is supplied as standard
- To assist nut threading, a tube of lubricant is supplied with all nuts of size HMV(C) 54E and larger
- To facilitate easy nut threading, all nuts from size HMV(C) 54E are equipped with two tommy bars and four mating holes on their front face
- Nuts from size HMV(C) 94E are equipped with eyebolts, allowing easy handling
- Nuts from size HMV(C) 94E have the starting position of the thread indicated, facilitating easy matching of thread positions on both the nut and mating thread
- Special threads and sizes available on request

Maximum working pressure of HMV(C)...E nuts

- HMV(C) 40E and smaller
60 MPa (8 700 psi)
- HMV(C) 40-60E
40 MPa (5 800 psi)
- HMV(C) 60-100E
30 MPa (4 350 psi)
- HMV(C) 100E and larger
25 MPa (3 600 psi)

Technical data – HMV E series (metric)

Designation	HMV E
Thread form	
HMV 10E – HMV 40E	ISO 965/111-1980 tolerance class 6H
HMV 41E – HMV 200E	ISO 2901-1977 tolerance class 7H
Mounting fluid	LHMF 300
Recommended pumps	
HMV 10E – HMV 54E	729124/TMJL 100/728619 E/TMJL 50
HMV 56E – HMV 92E	TMJL 100/728619 E/TMJL 50
HMV 94E – HMV 200E	728619 E/TMJL 50
Quick connection nipple	729832 A (included)
Other types available	
Inch series nuts	HMVC E series
Nuts without threads	HMV...E/A101

Mounting

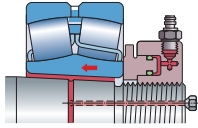

HMV ..E nut for driving the bearing onto a tapered seating.

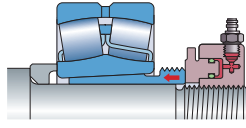

HMV ..E nut screwed onto the shaft for driving in a withdrawal sleeve.

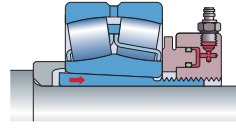

HMV ..E nut for driving the bearing onto an adapter sleeve.

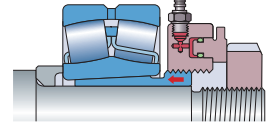

HMV ..E nut and special stop nut for driving in a withdrawal sleeve.

Dismounting

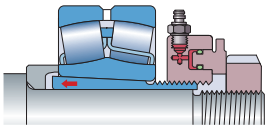

HMV ..E nut and stop ring in position to press an adapter sleeve free.

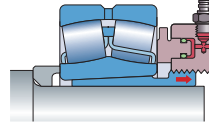

HMV ..E nut used to free a withdrawal sleeve.

Ordering details and dimensions – HMV E series (metric)

Designation	G thread	d ₁ mm	d ₂ mm	d ₃ mm	B mm	B ₁ mm	Permitted piston displacement mm	Piston area mm ²	Weight kg
HMV 10E	M50×1,5	50,5	104	114	38	4	5	2 900	2,70
HMV 11E	M55×2	55,5	109	120	38	4	5	3 150	2,75
HMV 12E	M60×2	60,5	115	125	38	5	5	3 300	2,80
HMV 13E	M65×2	65,5	121	130	38	5	5	3 600	3,00
HMV 14E	M70×2	70,5	127	135	38	5	5	3 800	3,20
HMV 15E	M75×2	75,5	132	140	38	5	5	4 000	3,40
HMV 16E	M80×2	80,5	137	146	38	5	5	4 200	3,70
HMV 17E	M85×2	85,5	142	150	38	5	5	4 400	3,75
HMV 18E	M90×2	90,5	147	156	38	5	5	4 700	4,00
HMV 19E	M95×2	95,5	153	162	38	5	5	4 900	4,30
HMV 20E	M100×2	100,5	158	166	38	6	5	5 100	4,40
HMV 21E	M105×2	105,5	163	172	38	6	5	5 300	4,65
HMV 22E	M110×2	110,5	169	178	38	6	5	5 600	4,95
HMV 23E	M115×2	115,5	174	182	38	6	5	5 800	5,00
HMV 24E	M120×2	120,5	179	188	38	6	5	6 000	5,25
HMV 25E	M125×2	125,5	184	192	38	6	5	6 200	5,35
HMV 26E	M130×2	130,5	190	198	38	6	5	6 400	5,65
HMV 27E	M135×2	135,5	195	204	38	6	5	6 600	5,90
HMV 28E	M140×2	140,5	200	208	38	7	5	6 800	6,00
HMV 29E	M145×2	145,5	206	214	39	7	5	7 300	6,50
HMV 30E	M150×2	150,5	211	220	39	7	5	7 500	6,60
HMV 31E	M155×3	155,5	218	226	39	7	5	8 100	6,95
HMV 32E	M160×3	160,5	224	232	40	7	6	8 600	7,60
HMV 33E	M165×3	165,5	229	238	40	7	6	8 900	7,90

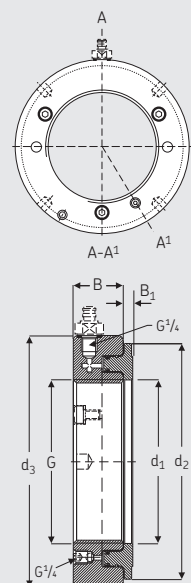

Ordering details and dimensions – HMV E series (metric)

Designation	G thread	d ₁ mm	d ₂ mm	d ₃ mm	B mm	B ₁ mm	Permitted	Piston	Weight
							piston	area	
							displacement	mm ²	kg
							mm		
HMV 34E	M170×3	170,5	235	244	41	7	6	9 400	8,40
HMV 36E	M180×3	180,5	247	256	41	7	6	10 300	9,15
HMV 38E	M190×3	191	259	270	42	8	7	11 500	10,5
HMV 40E	M200×3	201	271	282	43	8	8	12 500	11,5
HMV 41E	Tr205×4	207	276	288	43	8	8	12 800	12,0
HMV 42E	Tr210×4	212	282	294	44	8	9	13 400	12,5
HMV 43E	Tr215×4	217	287	300	44	8	9	13 700	13,0
HMV 44E	Tr220×4	222	293	306	44	8	9	14 400	13,5
HMV 45E	Tr225×4	227	300	312	45	8	9	15 200	14,5
HMV 46E	Tr230×4	232	305	318	45	8	9	15 500	14,5
HMV 47E	Tr235×4	237	311	326	46	8	10	16 200	16,0
HMV 48E	Tr240×4	242	316	330	46	9	10	16 500	16,0
HMV 50E	Tr250×4	252	329	342	46	9	10	17 600	17,5
HMV 52E	Tr260×4	262	341	356	47	9	11	18 800	19,0
HMV 54E	Tr270×4	272	352	368	48	9	12	19 800	20,5
HMV 56E	Tr280×4	282	363	380	49	9	12	21 100	22,0
HMV 58E	Tr290×4	292	375	390	49	9	13	22 400	22,5
HMV 60E	Tr300×4	302	386	404	51	10	14	23 600	25,5
HMV 62E	Tr310×5	312	397	416	52	10	14	24 900	27,0
HMV 64E	Tr320×5	322	409	428	53	10	14	26 300	29,5
HMV 66E	Tr330×5	332	419	438	53	10	14	27 000	30,0
HMV 68E	Tr340×5	342	430	450	54	10	14	28 400	31,5
HMV 69E	Tr345×5	347	436	456	54	10	14	29 400	32,5
HMV 70E	Tr350×5	352	442	464	56	10	14	29 900	35,0
HMV 72E	Tr360×5	362	455	472	56	10	15	31 300	35,5
HMV 73E	Tr365×5	367	460	482	57	11	15	31 700	38,5
HMV 74E	Tr370×5	372	466	486	57	11	16	32 800	39,0
HMV 76E	Tr380×5	382	476	498	58	11	16	33 500	40,5
HMV 77E	Tr385×5	387	483	504	58	11	16	34 700	41,0
HMV 80E	Tr400×5	402	499	522	60	11	17	36 700	45,5
HMV 82E	Tr410×5	412	510	534	61	11	17	38 300	48,0
HMV 84E	Tr420×5	422	522	546	61	11	17	40 000	50,0
HMV 86E	Tr430×5	432	532	556	62	11	17	40 800	52,5
HMV 88E	Tr440×5	442	543	566	62	12	17	42 500	54,0
HMV 90E	Tr450×5	452	554	580	64	12	17	44 100	57,5
HMV 92E	Tr460×5	462	565	590	64	12	17	45 100	60,0
HMV 94E	Tr470×5	472	576	602	65	12	18	46 900	62,0
HMV 96E	Tr480×5	482	587	612	65	12	19	48 600	63,0
HMV 98E	Tr490×5	492	597	624	66	12	19	49 500	66,0
HMV 100E	Tr500×5	502	609	636	67	12	19	51 500	70,0
HMV 102E	Tr510×6	512	624	648	68	12	20	53 300	74,0
HMV 104E	Tr520×6	522	634	658	68	13	20	54 300	75,0
HMV 106E	Tr530×6	532	645	670	69	13	21	56 200	79,0
HMV 108E	Tr540×6	542	657	682	69	13	21	58 200	81,0
HMV 110E	Tr550×6	552	667	693	70	13	21	59 200	84,0
HMV 112E	Tr560×6	562	678	704	71	13	22	61 200	88,0
HMV 114E	Tr570×6	572	689	716	72	13	23	63 200	91,0
HMV 116E	Tr580×6	582	699	726	72	13	23	64 200	94,0
HMV 120E	Tr600×6	602	721	748	73	13	23	67 300	100
HMV 126E	Tr630×6	632	754	782	74	14	23	72 900	110
HMV 130E	Tr650×6	652	775	804	75	14	23	76 200	115
HMV 134E	Tr670×6	672	796	826	76	14	24	79 500	120
HMV 138E	Tr690×6	692	819	848	77	14	25	84 200	127
HMV 142E	Tr710×7	712	840	870	78	15	25	87 700	135
HMV 150E	Tr750×7	752	883	912	79	15	25	95 200	146
HMV 160E	Tr800×7	802	936	965	80	16	25	103 900	161
HMV 170E	Tr850×7	852	990	1 020	83	16	26	114 600	181
HMV 180E	Tr900×7	902	1 043	1 075	86	17	30	124 100	205
HMV 190E	Tr950×8	952	1 097	1 126	86	17	30	135 700	218
HMV 200E	Tr1000×8	1 002	1 150	1 180	88	17	34	145 800	239

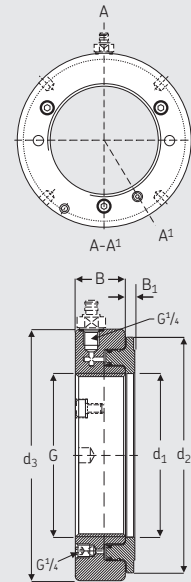



Technical data – HMVC E series (inch)

Designation	HMVC E
Thread form	American National Form Threads Class 3
HMVC 10E – HMVC 64E	ACME General Purpose Threads Class 3 G
HMVC 68E – HMVC 190E	
Mounting fluid	LHMF 300
Recommended pumps	
HMVC 10E – HMVC 52E	729124 / TMJL 100 / 728619 E / TMJL 50
HMVC 56E – HMVC 92E	TMJL 100 / 728619 E / TMJL 50
HMVC 94E – HMVC 190E	728619 E / TMJL 50
Quick connection nipple	729832A (included)
Other types available	
Inch series nuts	HMVC E series
Nuts without threads	HMV...E/A101

Ordering details and dimensions – HMVC E series (inch)

Designation	Pitch diameter		Threads	Pitch diameter			B	B ₁	Permitted piston displacement		Piston area	Weight
	G	in.		d ₁	d ₂	d ₃			in.	in.		
HMVC 10E	1.967	1.9309	18	2.0	4.1	4.5	1.5	0.16	0.20	4.5	6.0	
HMVC 11E	2.157	2.1209	18	2.2	4.3	4.7	1.5	0.16	0.20	4.9	6.1	
HMVC 12E	2.360	2.3239	18	2.4	4.5	4.9	1.5	0.20	0.20	5.1	6.2	
HMVC 13E	2.548	2.5119	18	2.6	4.8	5.1	1.5	0.20	0.20	5.6	6.6	
HMVC 14E	2.751	2.7149	18	2.8	5.0	5.3	1.5	0.20	0.20	5.9	7.1	
HMVC 15E	2.933	2.8789	12	3.0	5.2	5.5	1.5	0.20	0.20	6.2	7.5	
HMVC 16E	3.137	3.0829	12	3.2	5.4	5.7	1.5	0.20	0.20	6.5	8.2	
HMVC 17E	3.340	3.2859	12	3.4	5.6	5.9	1.5	0.20	0.20	6.8	8.3	
HMVC 18E	3.527	3.4729	12	3.6	5.8	6.1	1.5	0.20	0.20	7.3	8.8	
HMVC 19E	3.730	3.6759	12	3.8	6.0	6.4	1.5	0.20	0.20	7.6	9.5	
HMVC 20E	3.918	3.8639	12	4.0	6.2	6.5	1.5	0.24	0.20	7.9	9.7	
HMVC 21E	4.122	4.0679	12	4.2	6.4	6.8	1.5	0.24	0.20	8.2	10.3	
HMVC 22E	4.325	4.2709	12	4.4	6.7	7.0	1.5	0.24	0.20	8.7	10.9	
HMVC 24E	4.716	4.6619	12	4.7	7.0	7.4	1.5	0.24	0.20	9.3	11.6	
HMVC 26E	5.106	5.0519	12	5.1	7.5	7.8	1.5	0.24	0.20	9.9	12.5	
HMVC 28E	5.497	5.4429	12	5.5	7.9	8.2	1.5	0.28	0.20	10.5	13.2	
HMVC 30E	5.888	5.8339	12	5.9	8.3	8.7	1.5	0.28	0.20	11.6	14.6	
HMVC 32E	6.284	6.2028	8	6.3	8.8	9.1	1.6	0.28	0.24	13.3	16.8	
HMVC 34E	6.659	6.5778	8	6.7	9.3	9.6	1.6	0.28	0.24	14.6	18.5	
HMVC 36E	7.066	6.9848	8	7.1	9.7	10.1	1.6	0.28	0.24	16.0	20.2	
HMVC 38E	7.472	7.3908	8	7.5	10.2	10.6	1.7	0.31	0.28	17.8	23.1	
HMVC 40E	7.847	7.7658	8	7.9	10.7	11.1	1.7	0.31	0.31	19.4	25.4	
HMVC 44E	8.628	8.5468	8	8.7	11.5	12.0	1.7	0.31	0.35	22.3	29.8	
HMVC 46E	9.125	9.0440	8	9.1	12.0	12.5	1.8	0.31	0.35	24.0	31.9	
HMVC 48E	9.442	9.3337	6	9.5	12.4	13.0	1.8	0.35	0.39	25.6	35.3	
HMVC 52E	10.192	10.0837	6	10.3	13.4	14.0	1.9	0.35	0.43	29.1	41.9	
HMVC 54E	10.604	10.4960	6	10.7	13.9	14.5	1.9	0.35	0.47	30.7	45.2	
HMVC 56E	11.004	10.8957	6	11.1	14.3	15.0	1.9	0.35	0.47	32.7	48.5	
HMVC 60E	11.785	11.6767	6	11.9	15.2	15.9	2.0	0.39	0.55	36.6	56.2	
HMVC 64E	12.562	12.4537	6	12.7	16.1	16.9	2.1	0.39	0.55	40.8	65.0	
HMVC 68E	13.339	13.2190	5	13.5	16.9	17.7	2.1	0.39	0.55	44.0	69.4	
HMVC 72E	14.170	14.0500	5	14.3	17.9	18.6	2.2	0.39	0.59	48.5	78.3	
HMVC 76E	14.957	14.8370	5	15.0	18.7	19.6	2.3	0.43	0.63	51.9	89.3	
HMVC 80E	15.745	15.6250	5	15.8	19.6	20.6	2.4	0.43	0.67	56.9	100	
HMVC 84E	16.532	16.4120	5	16.6	20.6	21.5	2.4	0.43	0.67	62.0	110	
HMVC 88E	17.319	17.1990	5	17.4	21.4	22.3	2.4	0.47	0.67	65.9	119	
HMVC 92E	18.107	17.9870	5	18.2	22.2	23.3	2.5	0.47	0.67	69.9	132	
HMVC 96E	18.894	18.7740	5	19.0	23.1	24.1	2.6	0.47	0.75	75.3	139	
HMVC 100E	19.682	19.5620	5	19.8	24.0	25.0	2.6	0.47	0.75	79.8	154	

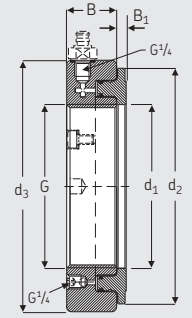

Ordering details and dimensions – HMVC E series (inch)

Designation	Pitch diameter		Threads	Pitch diameters			B	B ₁	Permitted piston displacement	Piston area	Weight
	G	in.		d ₁	d ₂	d ₃					
	in.		–	in.	in.	in.	in.	in.	in ²	lb	
HMVC 106E	20.867	20.7220	4	20.9	25.4	26.4	2.7	0.51	0.83	87.1	174
HMVC 112E	22.048	21.9030	4	22.1	26.7	27.7	2.8	0.51	0.87	94.9	194
HMVC 120E	23.623	23.4780	4	23.7	28.4	29.4	2.9	0.51	0.91	104.3	220
HMVC 126E	24.804	24.6590	4	24.9	29.7	30.8	2.9	0.55	0.91	113.0	243
HMVC 134E	26.379	26.2340	4	26.5	31.3	32.5	3.0	0.55	0.94	123.2	265
HMVC 142E	27.961	27.7740	3	28.0	33.1	34.3	3.1	0.59	0.98	135.9	298
HMVC 150E	29.536	29.3490	3	29.6	34.8	35.9	3.1	0.59	0.98	147.6	322
HMVC 160E	31.504	31.3170	3	31.6	36.9	38.0	3.1	0.63	0.98	161.0	355
HMVC 170E	33.473	33.2860	3	33.5	39.0	40.2	3.3	0.63	1.02	177.6	399
HMVC 180E	35.441	35.2540	3	35.5	41.1	42.3	3.4	0.67	1.18	192.4	452
HMVC 190E	37.410	37.2230	3	37.5	43.2	44.3	3.4	0.67	1.18	210.3	481

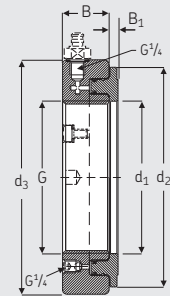

Technical data – HMV E/A101 series (unthreaded)

Designation	HMV E/A101
Mounting fluid	LHMF 300
Recommended pumps	
HMV 10E/A101 – HMV 52E/A101	729124 / TMJL 100 / 728619 E / TMJL 50
HMV 54E/A101 – HMV 92E/A101	TMJL 100 / 728619 E / TMJL 50
HMV 94E/A101 – HMV 200E/A101	728619 E / TMJL 50
Quick connection nipple	729832 A (included)

Ordering details and dimensions – HMV E/A101 series (unthreaded)

Designation	Bore diameter		Designation	Bore diameter		Designation	Bore diameter	
	G	in.		G	in.		G	in.
HMV 10E/A101	46,7	1.84	HMV 41E/A101	200,2	7.88	HMV 86E/A101	424,7	16.72
HMV 11E/A101	51,1	2.01	HMV 42E/A101	205,2	8.08	HMV 88E/A101	434,7	17.11
HMV 12E/A101	56,1	2.21	HMV 43E/A101	210,2	8.28	HMV 90E/A101	444,7	17.51
HMV 13E/A101	61,1	2.41	HMV 44E/A101	215,2	8.47	HMV 92E/A101	454,7	17.90
HMV 14E/A101	66,1	2.60	HMV 45E/A101	220,2	8.67	HMV 94E/A101	464,7	18.30
HMV 15E/A101	71,1	2.80	HMV 46E/A101	225,2	8.87	HMV 96E/A101	474,7	18.69
HMV 16E/A101	76,1	3.00	HMV 47E/A101	230,2	9.06	HMV 98E/A101	484,7	19.08
HMV 17E/A101	81,1	3.19	HMV 48E/A101	235,2	9.26	HMV 100E/A101	494,7	19.48
HMV 18E/A101	86,1	3.39	HMV 50E/A101	245,2	9.65	HMV 102E/A101	503,7	19.83
HMV 19E/A101	91,1	3.59	HMV 52E/A101	255,2	10.05	HMV 104E/A101	513,7	20.22
HMV 20E/A101	96,1	3.78	HMV 54E/A101	265,2	10.44	HMV 106E/A101	523,7	20.62
HMV 21E/A101	101,1	3.98	HMV 56E/A101	275,2	10.83	HMV 108E/A101	533,7	21.01
HMV 22E/A101	106,1	4.18	HMV 58E/A101	285,2	11.23	HMV 110E/A101	543,7	21.41
HMV 23E/A101	111,1	4.37	HMV 60E/A101	295,2	11.62	HMV 112E/A101	553,7	21.80
HMV 24E/A101	116,1	4.57	HMV 62E/A101	304,7	12.00	HMV 114E/A101	563,7	22.19
HMV 25E/A101	121,1	4.77	HMV 64E/A101	314,7	12.39	HMV 116E/A101	573,7	22.59
HMV 26E/A101	126,1	4.96	HMV 66E/A101	324,7	12.78	HMV 120E/A101	593,7	23.37
HMV 27E/A101	131,1	5.16	HMV 68E/A101	334,7	13.18	HMV 126E/A101	623,7	24.56
HMV 28E/A101	136,1	5.36	HMV 69E/A101	339,7	13.37	HMV 130E/A101	643,7	25.34
HMV 29E/A101	141,1	5.56	HMV 70E/A101	344,7	13.57	HMV 134E/A101	663,7	26.13
HMV 30E/A101	146,1	5.75	HMV 72E/A101	354,7	13.96	HMV 138E/A101	683,7	26.92
HMV 31E/A101	149,8	5.90	HMV 73E/A101	359,7	14.16	HMV 142E/A101	702,7	27.67
HMV 32E/A101	154,8	6.09	HMV 74E/A101	364,7	14.36	HMV 150E/A101	742,7	29.24
HMV 33E/A101	159,8	6.29	HMV 76E/A101	374,7	14.75	HMV 160E/A101	792,7	31.21
HMV 34E/A101	164,8	6.49	HMV 77E/A101	379,7	14.95	HMV 170E/A101	842,7	33.18
HMV 36E/A101	174,8	6.88	HMV 80E/A101	394,7	15.54	HMV 180E/A101	892,7	35.15
HMV 38E/A101	184,8	7.28	HMV 82E/A101	404,7	15.93	HMV 190E/A101	941,7	37.07
HMV 40E/A101	194,8	7.67	HMV 84E/A101	414,7	16.33	HMV 200E/A101	991,7	39.04

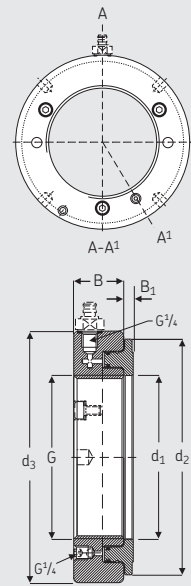

Hydraulic pump and oil injector selection guide

Max. working pressure	Pump	Type	Oil container capacity	Connection nipple	Application examples*
30 MPa (4 350 psi)	THAP 030E	Air-driven pump	Separate container	G ³ / ₄	SKF OK Coupling hydraulic chamber
50 MPa (7 250 psi)	TMJL 50	Hand operated pump	2 700 cm ³ (165 in. ³)	G ¹ / ₄	All HMV ..E (dismounting with sleeves only) SKF OK Coupling hydraulic chamber
100 MPa (14 500 psi)	729124	Hand operated pump	250 cm ³ (15 in. ³)	G ¹ / ₄	≤ HMV 54E (dismounting with sleeves only) Oil injection for small bearings
	TMJL 100	Hand operated pump	800 cm ³ (48 in. ³)	G ¹ / ₄	≤ HMV 92E (dismounting with sleeves only) Oil injection for medium bearings
150 MPa (21 750 psi)	THAP 150E	Air-driven pump	Separate container	G ³ / ₄	Bolt tensioners, propellers Oil injection for large bearing seatings
	728619 E	Hand operated pump	2 550 cm ³ (155 in. ³)	G ¹ / ₄	All HMV ..E nuts (dismounting with sleeves only) Oil injection for bearing seatings
300 MPa (43 500 psi)	THAP 300E	Air-driven oil injector	Separate container	G ³ / ₄	OK Couplings Large pressure joints Oil injection for bearing seatings
	226400 E	Hand operated oil injector	200 cm ³ (12.2 in. ³)	G ³ / ₄	OK Couplings Adapter / withdrawal sleeves Oil injection for bearing seatings Pressure joints
	729101/300MPA	Oil injection kit	200 cm ³ (12.2 in. ³)	Several	OK Couplings Adapter / withdrawal sleeves Oil injection for bearing seatings Pressure joints Complete kit / set suitable for many applications
	THKI 300	Oil injection set	200 cm ³ (12.2 in. ³)	Several	Adapter / withdrawal sleeves Oil injection for bearing seatings Pressure joints Complete kit / set suitable for many applications
400 MPa (58 000 psi)	THAP 400E	Air-driven oil injector	Separate container	G ³ / ₄	OK Couplings Large pressure joints Oil injection for bearing seatings
	226400 E/400	Hand operated oil injector	200 cm ³ (12.2 in. ³)	G ³ / ₄	OK Couplings Adapter / withdrawal sleeves Oil injection for bearing seatings Pressure joints
	729101/400MPA	Oil injection kit	200 cm ³ (12.2 in. ³)	Several	OK Couplings Adapter / withdrawal sleeves Oil injection for bearing seatings Pressure joints Complete kit / set suitable for many applications
	THKI 400	Oil injection set	200 cm ³ (12.2 in. ³)	Several	Adapter / withdrawal sleeves Oil injection for bearing seatings Pressure joints Complete kit / set suitable for many applications

* The interference fit and application size may mean that a pump / injector with a higher pressure and/or container volume is required.

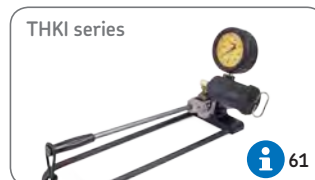

Hydraulic pumps



50 MPa (7 250 psi)

SKF Hydraulic Pump TMJL 50

The SKF TMJL 50 is mainly intended for larger SKF Hydraulic Nuts and SKF OK Coupling hydraulic chambers, but is also suitable for applications where a maximum pressure of 50 MPa (7 250 psi) is required.

- Large oil container capacity 2 700 cm³ (165 in.³)
- Over pressure valve and connection port for a pressure gauge
- Packed in a sturdy protective case

Applications

- SKF OK Coupling hydraulic chambers
- All sizes SKF Hydraulic Nuts
- All other oil injection applications where the maximum pressure is 50 MPa (7 250 psi)



100 MPa (14 500 psi)

SKF Hydraulic Pump 729124

The SKF 729124 is mainly intended for SKF Hydraulic Nuts (\leq HMV 54E) to mount bearings or components where a maximum pressure of 100 MPa (14 500 psi) is required.

- Oil container capacity 250 cm³ (15 in.³)
- Fitted with a pressure gauge
- Packed in a sturdy protective case

Applications

- SKF Hydraulic Nuts \leq HMV 54E
- All other oil injection applications where the maximum pressure is 100 MPa (14 500 psi)
- For applications where space does not permit the use of a quick connect coupling and nipple, such as AOH sleeves, a special pump design is available (SKF 729124 A)

Technical data

Designation	TMJL 50	729124	TMJL 100	728619 E
Maximum pressure	50 MPa (7 250 psi)	100 MPa (14 500 psi)	100 MPa (14 500 psi)	150 MPa (21 750 psi)
Oil container capacity	2 700 cm ³ (165 in. ³)	250 cm ³ (15 in. ³)	800 cm ³ (48 in. ³)	2 550 cm ³ (155 in. ³)
Volume/stroke	3,5 cm ³ (0.21 in. ³)	0,5 cm ³ (0.03 in. ³)	1,0 cm ³ (0.06 in. ³)	1st stage: 20 cm ³ below 2,5 MPa (1.2 in. ³ below 362 psi) 2nd stage: 1 cm ³ above 2,5 MPa (0.06 in. ³ above 362 psi)
Length of pressure hose fitted with quick connection coupling	3 000 mm (118 in.)	1 500 mm (59 in.)	3 000 mm (118 in.)	3 000 mm (118 in.)
Connection nipple (included)	G ³ / ₄ quick connection	G ³ / ₄ quick connection	G ³ / ₄ quick connection	G ³ / ₄ quick connection
Weight	12 kg (26 lb)	3,5 kg (8 lb)	13 kg (29 lb)	11,4 kg (25 lb)

All SKF Hydraulic Pumps are filled with SKF Mounting Fluid and are supplied with an extra litre of fluid.



Large oil container 100 MPa (14 500 psi)

SKF Hydraulic Pump TMJL 100

The SKF TMJL 100 pump is mainly intended for use with hydraulic nuts (\leq HMV 92E) to mount bearings or components where a maximum pressure of 100 MPa (14 500 psi) is required.

- Oil container capacity 800 cm³ (48 in.³)
- Fitted with a pressure gauge
- Packed in a sturdy protective case

Applications

- SKF Hydraulic Nuts \leq HMV 92E
- All other oil injection applications where the maximum pressure is 100 MPa (14 500 psi)
- Suitable with SKF Hydraulic Assisted Pullers TMHP series



150 MPa (21 750 psi)

SKF Hydraulic Pump 728619 E

The SKF 728619 E is a two-stage pump suitable for use with SKF Supergrip Bolts and to mount bearings or components where a maximum pressure of 150 MPa (21 750 psi) is required.

- Oil container capacity 2 550 cm³ (155 in.³)
- Two stage pressure pumping
- Fitted with a pressure gauge
- Packed in a sturdy protective case

Applications

- SKF Supergrip Bolts
- All other oil injection applications where the maximum pressure is 150 MPa (21 750 psi)
- All sizes SKF Hydraulic Nuts



SKF Mounting Fluid LHM 300 and SKF Dismounting Fluid LHDF 900

SKF mounting and dismounting fluids are suitable for use with SKF hydraulic equipment, including hydraulic pumps, HMV ..E nuts and oil injection tools in mounting and dismounting jobs. All SKF Hydraulic Pumps are filled with SKF Mounting Fluid LHM 300 and are supplied with an extra litre of fluid.

For more information, see page 69

Oil Injectors

To enable the SKF Oil Injection Method to be used, a range of oil injectors, kits and sets are available. Depending on the model chosen, working pressures up to 400 MPa (58 000 psi) can be achieved. In addition, a comprehensive range of high pressure accessories such as pipes, connection nipples, extension pipes and plugs permit the use of SKF Oil Injectors for many different applications.



300 and 400 MPa (43 500 and 58 000 psi)

SKF Oil Injector 226400 E series

The 226400 E series is suitable for many applications using the SKF Oil Injection Method. The injector is supplied with an oil reservoir in a compact carrying case.

The injector can be mounted directly onto the work piece or connected to an adapter block to make a floor standing model, making it easy to connect pressure gauges and high-pressure pipes. For applications where 400 MPa (58 000 psi) is required, the SKF 226400 E/400 is available.

- Easy to operate.
- Compact carrying case.
- When the pressure is released, the unused oil is automatically returned to the reservoir, minimizing the risk of oil leakage to the environment.
- Oil container capacity 200 cm³ (12.2 in.³).
- Can be used with a wide range of accessories, such as:
 - Adapter block
 - Pressure gauges
 - High pressure pipes
 - Connecting nipples



Technical data

Designation	226400 E 729101/300MPa	226400 E/400 729101/400MPa	THKI 300	THKI 400
Maximum pressure	300 MPa (43 500 psi)	400 MPa (58 000 psi)	300 MPa (43 500 psi)	400 MPa (58 000 psi)
Volume per stroke	0,23 cm ³ (0.014 in. ³)	0,23 cm ³ (0.014 in. ³)	0,23 cm ³ (0.014 in. ³)	0,23 cm ³ (0.014 in. ³)
Oil reservoir capacity	200 cm ³ (12.2 in. ³)	200 cm ³ (12.2 in. ³)	200 cm ³ (12.2 in. ³)	200 cm ³ (12.2 in. ³)
Connecting threads	G ³ / ₄	G ³ / ₄	G ³ / ₄	G ³ / ₄



300 and 400 MPa (43 500 and 58 000 psi)

SKF Oil Injection Kits 729101 series

The 729101 series of SKF Oil Injection Kits are suitable for many applications using the SKF Oil Injection Method. Each kit contains an SKF Oil Injector complete with a high pressure pipe, pressure gauge, adapter block and a range of connection nipples.

- Injector can be used directly on the application or by connecting to the accessories provided
- All items packed in a sturdy, compact carrying case especially suitable for field use
- When the pressure is released, the unused oil is automatically returned to the reservoir, minimizing the risk of oil leakage to the environment
- Oil container capacity 200 cm³ (12.2 in.³).



300 and 400 MPa (43 500 and 58 000 psi)

SKF Oil Injection Set THKI series

The SKF THKI series is used for the mounting and dismounting of pressure joints of all sizes and applications such as rolling bearings, couplings, gears, flywheels and railway wheels. The set consists of a stand-mounted oil injector complete with a high pressure pipe, pressure gauge and a range of connection nipples.

- Designed to be especially suitable for workshop use.
- When the pressure is released, the unused oil is automatically returned to the reservoir, minimizing the risk of oil leakage to the environment.
- Oil container capacity 200 cm³ (12.2 in.³).
- Can be used for applications requiring a maximum pressure of up to 400 MPa (58 000 psi).

Contents list

Designation	729101/300MPA	729101/400MPA	THKI 300	THKI 400
Oil injector	226400 E	226400 E/400	1077589	1077589/3
Adapter block	226402	226402	227957 A	227957 A/400 MP
Pressure gauge	1077589	1077589/3	1077589	1077589/3
High pressure pipe (G ^{3/4} -1/4)	227957 A	227957 A/400 MP	227957 A	227957 A/400 MP
Connection nipple (G ^{1/4} -1/8)	1014357 A	–	1014357 A	–
Connection nipple (G ^{1/4} -1/2)	1016402E	1016402E	1016402E	1016402E
Connection nipple (G ^{1/4} -3/4)	228027E	228027E	228027E	228027E
Mounting fluid	–	–	LHMF 300/1	LHMF 300/1
Carrying case	Yes	Yes	Yes	Yes

Air-driven hydraulic pumps and injectors

30, 150, 300 and 400 MPa (4 350, 21 750, 43 500 and 58 000 psi)

SKF Air-driven Hydraulic Pumps and Oil Injectors, THAP E series

The THAP E air-driven hydraulic pumps and oil injectors are available in four different pressure versions. They can be used for mounting OK Couplings, large pressure joints such as bearings, flywheels, couplings and railway wheels. The THAP E unit consists of a hydraulic pump or high pressure oil injector, driven by an air motor.

The units are supplied in a sturdy case including oil suction and return hoses with quick connect couplings. The units can also be supplied in complete sets, consisting of a THAP E and such accessories as a pressure gauge, high pressure pipe or pressure hose.

- Time savings compared to hand operated pumps and oil injectors
- Portable
- Continuous supply of oil
- Sturdy storage boxes
- Low, medium and high pressure units

Applications

- SKF OK Couplings
- Mounting bearings
- Mounting ship propellers, rudder pintles, railway wheels and other similar applications

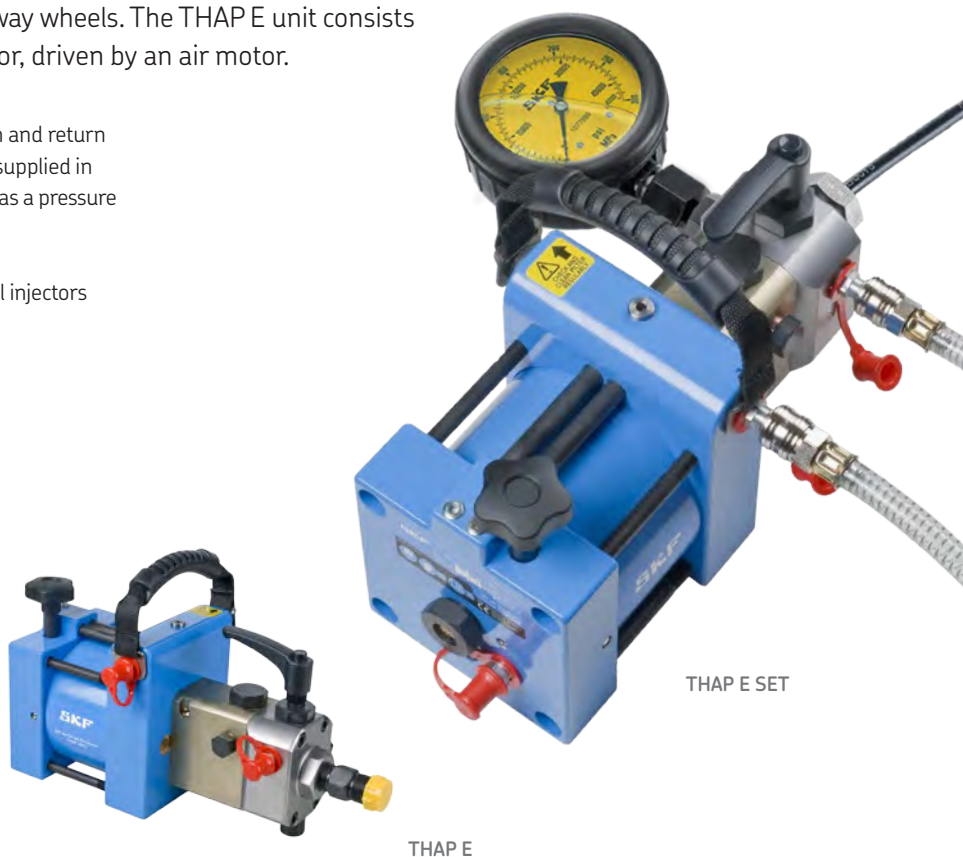

Technical data					
Designation	THAP 030E	THAP 150E	THAP 300E	THAP 400E	
Nominal hydraulic pressure	30 MPa (4 350 psi)	150 MPa (21 750 psi)	300 MPa (43 500 psi)	400 MPa (58 000 psi)	
Maximum air pressure	7 bar (101.5 psi)	7 bar (101.5 psi)	7 bar (101.5 psi)	7 bar (101.5 psi)	
Volume/stroke	10 cm ³ (0.61 in. ³)	1,92 cm ³ (0.12 in. ³)	0,83 cm ³ (0.05 in. ³)	0,64 cm ³ (0.039 in. ³)	
Oil outlet	G ³ / ₄	G ³ / ₄	G ³ / ₄	G ³ / ₄	
Length	350 mm (13.9 in.)	350 mm (13.9 in.)	405 mm (16 in.)	405 mm (16 in.)	
Height	202 mm (8 in.)	202 mm (8 in.)	202 mm (8 in.)	202 mm (8 in.)	
Width	171 mm (6.7 in.)	171 mm (6.7 in.)	171 mm (6.7 in.)	171 mm (6.7 in.)	
Weight	11,5 kg (25.3 lb)	11,5 kg (25.3 lb)	13 kg (28.6 lb)	13 kg (28.6 lb)	

Also available as complete set in carrying case

THAP 030E/SET	Consisting of pump, high pressure hose and connecting nipples.
THAP 150E/SET	Consisting of pump, pressure gauge, high pressure hose and connecting nipples.
THAP 300E/SET	Consisting of oil injector, pressure gauge and high pressure pipe.
THAP 400E/SET	Consisting of oil injector, pressure gauge and high pressure pipe.

100 to 400 MPa (14 500 to 58 000 psi)

SKF Pressure Gauges

SKF Pressure Gauges are designed to fit SKF Hydraulic Pumps and SKF Oil Injectors. The gauges are all liquid filled and/or equipped with a restriction screw in order to absorb any sudden pressure drop thereby preventing damage. Safety glass and blowout discs are standard for all gauges and all have dual scales (MPa/psi).

- Covers pressures of 100 to 400 MPa (14 500 to 58 000 psi)
- Protection against sudden pressure drops
- Safety glass and blow out discs on all gauges
- Stainless steel case
- Dual scales MPa/psi
- Easy to read, high visibility yellow gauge faces



The Digital oil pressure gauge, THGD 100, is used to accurately measure the hydraulic pressure when mounting bearings using the SKF Drive-up Method.



1077587



1077589



1077589/3



1077587/2

Technical data

Designation	Pressure range		Diameter (H)		Connection thread	Weight		Accuracy
	MPa	psi	mm	in.		kg	lb	
1077587	0-100	0-14 500	100	3.94	G ¹ / ₂	0,80	1.8	1
1077587/2	0-100	0-14 500	63	2.48	G ¹ / ₄	0,25	0.6	1,6
THGD 100*	0-100	0-15 000	79	3.10	G ¹ / ₄	0,54	1.2	±0,1
1077589	0-300	0-43 500	100	3.94	G ¹ / ₂	0,80	1.8	1
1077589/3	0-400	0-58 000	100	3.94	G ¹ / ₂	0,80	1.8	1

* Digital pressure gauge

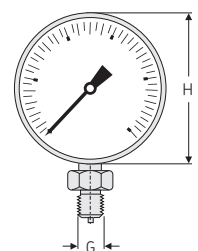

Accessories

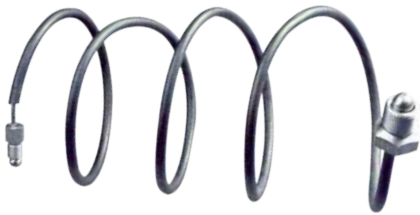

Maximum working pressure 300 MPa (43 500 psi)

SKF High-pressure Pipes

The range of SKF High-pressure Pipes covers most applications where there is a requirement to transfer oil at high pressure. They consist of a steel pipe with a steel ball fitted to both ends. Two swivelling connection nipples press these balls against the seating of the connecting hole and seal against oil leakage.

- Wide range of pipes
- All pipes are pressure tested to 100 MPa (14 500 psi) over recommended working pressure
- Special lengths up to 4 000 mm (157 in.) and variants can be made on request

Technical data

Maximum working pressure	300 MPa (43 500 psi)
Test pressure	400 MPa (58 000 psi)
Test quantity	100%
Outer pipe diameter	4 mm (0.16 in.)
Inner pipe diameter	2 mm (0.08 in.)
Pipe lengths	Between 300 mm (12 in.) and 4 000 mm (157 in.) can be ordered e.g. 227957A/3000 (3 000 mm long)

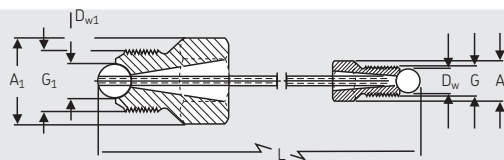

Designation	G		G ₁		A		A ₁		D _w		D _{w1}		L		Weight	
	mm	in.	mm	in.	mm	in.	mm	in.	mm	in.	mm	in.	mm	in.	kg	lb
721740 A	G ¹ / ₈	G ³ / ₄	11,5	0.45	36,9	1.45	7,94	0.31	15,88	0.63	1 000	39	0,3	0.7		
227957 A*	G ¹ / ₄	G ³ / ₄	17,3	0.68	36,9	1.45	11,11	0.44	15,88	0.63	2 000	78	0,4	0.9		
227958 A*	G ³ / ₄	G ³ / ₄	36,9	1.45	36,9	1.45	15,88	0.63	15,88	0.63	2 000	78	0,6	1.3		
1020612 A**	G ¹ / ₄	G ¹ / ₄	17,3	0.68	17,3	0.68	11,11	0.44	11,11	0.44	1 000	39	0,5	1.1		
728017 A	G ¹ / ₄	G ¹ / ₄	17,3	0.68	17,3	0.68	11,11	0.44	7,94	0.31	300	12	0,2	0.4		

* These pipes are also available in a 400 MPa execution. Designations are 227957 A/400MP and 227958 A/400MP. Outer diameter of the pipe is 6 mm (0.24 in.)

** Maximum working pressure 400 MPa (58 000 psi). Test pressure 500 MPa (72 500 psi) Outer diameter of the pipe 6 mm (0.24 in.).



Safety note:

For safety reasons, these high-pressure pipes have a maximum service life. All SKF high pressure pipes are hard-marked with the year in which their service life expires; e.g. DO NOT USE AFTER 2021. High pressure pipes are marked with their maximum working pressure e.g. MAX 400 MPa. The pipe colour also indicates the maximum working pressure. Black pipes can be used up to 300 MPa, whilst grey pipes can be used up to 400 MPa.

All flexible pressure hoses are subject to ageing and, after a number of years, the performance deteriorates. All SKF flexible pressure hoses are hard marked with the year in which their life expires, e.g. LIFE EXPIRES 2018.



Maximum working pressure up to 150 MPa (21 750 psi)

SKF Flexible High-pressure Hoses

The SKF flexible pressure hoses are designed to be used together with the quick connect coupling SKF 729831 A and nipple SKF 729832 A on the range of SKF Hydraulic Pumps.

Technical data

Designation	Bore diameter		Outside diameter		Maximum working pressure		Minimum burst pressure		Minimum bending radius		End fittings	Working temperature		Length		Weight	
	mm	in.	mm	in.	MPa	psi	MPa	psi	mm	in.		°C	°F	mm	in.	kg	lb
729126	4,0	0.16	10	0.39	100	14 500	300	43 500	65	2.6	G ¹ / ₄	-30/80	-22/176	1 500	59	0,4	0.9
729834	5,0	0.20	11	0.43	150	21 750	450	65 250	150	5.9	G ¹ / ₄	-30/80	-22/176	3 000	118	0,9	2.0

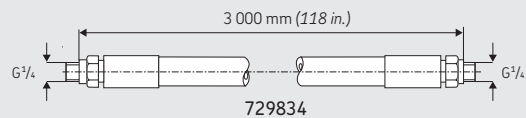
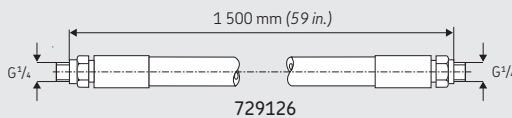

For accurate bearing clearance measurement

SKF Feeler Gauges 729865 series

As an alternative to the SKF Drive-up method SKF Feeler Gauges can be used to measure the internal clearance when adjusting spherical roller bearings. Two types are available, one with 13 blades of 100 mm (4 in.) length and the other with 29 blades of 200 mm (8 in.) length.

- Highly accurate measurement
- 729865 A is supplied with protective plastic cover
- 729865 B is supplied with protective steel cage



Technical data

Designation	Blade length		Blade thickness					
	mm	in.	mm	in.	mm	in.	mm	in.
729865 A	100	4.0	0,03	0.0012	0,08	0.0031	0,14	0.0055
			0,04	0.0016	0,09	0.0035	0,15	0.0059
			0,05	0.0020	0,10	0.0039	0,20	0.0079
			0,06	0.0024	0,12	0.0047	0,30	0.0118
			0,07	0.0028				
729865 B	200	8.0	0,05	0.0020	0,18	0.0071	0,60	0.0236
			0,09	0.0035	0,19	0.0075	0,65	0.0256
			0,10	0.0039	0,20	0.0079	0,70	0.0276
			0,11	0.0043	0,25	0.0098	0,75	0.0295
			0,12	0.0047	0,30	0.0118	0,80	0.0315
			0,13	0.0051	0,35	0.0138	0,85	0.0335
			0,14	0.0055	0,40	0.0157	0,90	0.0354
			0,15	0.0059	0,45	0.0177	0,95	0.0374
			0,16	0.0063	0,50	0.0197	1,00	0.0394
			0,17	0.0067	0,55	0.0216		



For easy pressure hose connection

SKF Quick Connecting Coupling and Nipples

One coupling and two different nipples are available to connect SKF Hydraulic Pumps to the work piece. When nipples with other thread types are required, select an additional SKF nipple from the range to make the connection. SKF Nipple 729832 A is supplied standard with all SKF Hydraulic Nuts HMV ..E series.

Technical data

Designation	Thread	Dimensions				Maximum pressure			
		D ₂ mm	in.	C mm	in.	A mm	in.	MPa	psi
Coupling		d ₂							
729831 A	G ¹ / ₄	24	0.94	27	1.06	58	2.28	150	21 750
Nipples		d ₁		B		A			
729832 A	G ¹ / ₄	22	0.87	14	0.55	46	1.81	150	21 750
729100	G ¹ / ₈	17	0.67	14	0.55	43	1.69	100	14 500

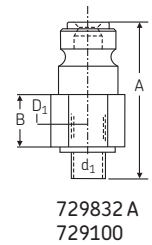
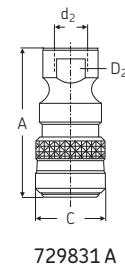

Up to 400 MPa (58 000 psi)

Plugs for oil ducts and vent holes

SKF plugs have been designed to seal off oil connections at a maximum pressure of 400 MPa (58 000 psi).

Technical data

Designation	Thread	Length	
		mm	in.
233950 E	G ¹ / ₄	15	0.59
729944 E	G ¹ / ₂	17	0.67
1030816 E	G ³ / ₄	23	0.90

Maximum working pressure 400 MPa (58 000 psi)

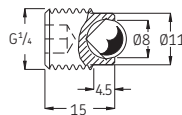

Plug 233950 E

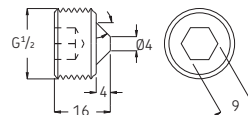

Plug 729944 E

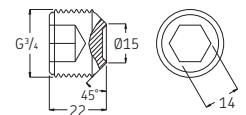

Plug 1030816 E

SKF Connection Nipples

SKF provides a wide range of connection nipples covering many different thread combinations and sizes. They are used as adapters to enable pipes and hoses to be connected to different thread sizes.



Technical data – Nipples with metric and G pipe threads

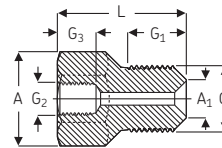

Designation	G		Max. working pressure		Dimensions								Width across flats mm		
	G ₂		Mpa	Psi	A	A ₁	G ₁	G ₃	L						
					mm	in.	mm	in.	mm	in.	mm	in.	mm	in.	
1077456/100MPA	M8	M6	100	14 500	11	0.43	5	0.20	15	0.59	9	0.35	33	1.30	10
1077455/100MPA	G ¹ / ₈	M6	100	14 500	11	0.43	7	0.28	15	0.59	9	0.35	33	1.30	10
1014357 A	G ¹ / ₈	G ¹ / ₄	300	43 500	25,4	1.00	7	0.28	15	0.59	15	0.59	43	1.69	22
1009030 B	G ¹ / ₈	G ³ / ₈	300	43 500	25,4	1.00	7	0.28	15	0.59	15	0.59	42	1.65	22
1019950	G ¹ / ₈	G ¹ / ₂	300	43 500	36,9	1.45	7	0.28	15	0.59	14	0.55	50	1.97	32
1018219 E	G ¹ / ₄	G ³ / ₈	400	58 000	25,4	1.00	9,5	0.37	17	0.67	15	0.59	45	1.77	22
1009030 E	G ¹ / ₄	G ³ / ₄	400	58 000	36,9	1.45	9,5	0.37	17	0.67	20	0.79	54	2.13	32
1012783 E	G ³ / ₈	G ¹ / ₄	400	58 000	25,4	1.00	10	0.39	17	0.67	15	0.59	43	1.96	22
1008593 E	G ³ / ₈	G ³ / ₄	400	58 000	36,9	1.45	10	0.39	17	0.67	20	0.79	53	2.09	32
1016402 E	G ¹ / ₂	G ¹ / ₄	400	58 000	25,4	1.00	14	0.55	20	0.79	15	0.59	43	1.96	22
729146	G ¹ / ₂	G ³ / ₄	300	43 500	36,9	1.45	–	–	17	0.67	20	0.79	50	1.97	32
228027 E	G ³ / ₄	G ¹ / ₄	400	58 000	36,9	1.45	15	0.59	22	0.87	15	0.59	50	1.97	32

Technical data – Nipples with NPT tapered threads

Designation	G		Max. working pressure		Dimensions								Width across flats mm	
	G ₂		Mpa	Psi	A	A ₁	G ₁	G ₃	L					
					mm	in.	mm	in.	mm	in.	mm	in.	mm	in.
729654/150MPA	NPT ¹ / ₄ "	G ¹ / ₄	150	21 750	25,4	1.00	15	0.59	15	0.59	42	1.65	22	
729655/150MPA	NPT ³ / ₈ "	G ¹ / ₄	150	21 750	25,4	1.00	15	0.59	15	0.59	40	1.57	22	
729106/100MPA	G ¹ / ₄	NPT ³ / ₈ "	100	14 500	36,9	1.45	17	0.67	15	0.59	50	1.97	32	
729656/150MPA	NPT ³ / ₄ "	G ¹ / ₄	150	21 750	36,9	1.45	20	0.79	15	0.59	45	1.77	32	

Catering for adapter and withdrawal sleeve applications

SKF Extension Pipes with Connecting Nipples



M4 extension pipe with connection nipple

Used to extend a high-pressure pipe with a G¹/₄ nipple (e.g. SKF 227957 A) when the sleeve connection hole has an M4 thread. The extension pipe and connection nipple should be ordered as separate items.

M6 extension pipe with connection nipple

Used to extend a high-pressure pipe with a G¹/₄ nipple (e.g. SKF 227957 A) when the sleeve connection hole has a M6 thread. The extension pipe and connection nipple should be ordered as separate items.

G¹/₄ extension pipe with connection nipple

Used to extend a high-pressure pipe with a G³/₄ nipple (e.g. SKF 227958 A) when the sleeve connection hole has a G¹/₄ thread. The extension pipe and connection nipple should be ordered as separate items.

G¹/₈ extension pipe

Used to extend a high-pressure pipe with a G¹/₄ nipple (e.g. SKF 227957 A) when the sleeve connection hole has a G¹/₈ thread.

Technical data

M4 extension pipe with connection nipple

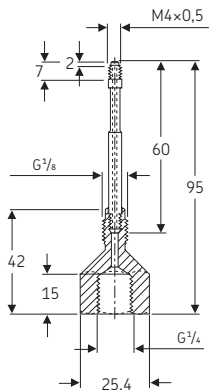

Designation	Max. pressure
pipe 234064	50 MPa (7 250 psi)
nipple 234063	50 MPa (7 250 psi)

M6 extension pipe with connection nipple

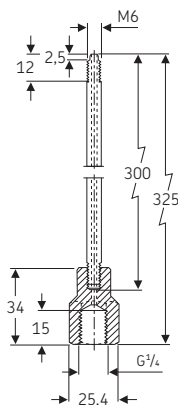

Designation	Max. pressure
pipe 1077453/100MPA	100 MPa (14 500 psi)
nipple 1077454/100MPA	100 MPa (14 500 psi)

G¹/₄ extension pipe with connection nipple

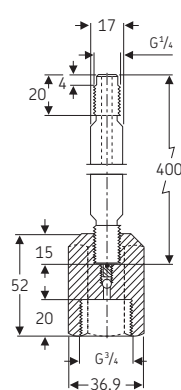

Designation	Max. pressure
pipe 227964/100MPA	100 MPa (14 500 psi)
nipple 227963/100MPA	100 MPa (14 500 psi)

G¹/₈ extension pipe

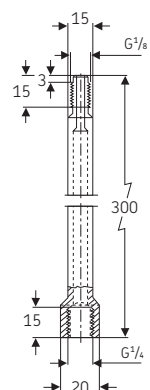

Designation	Max. pressure
227965/100MPA	100 MPa (14 500 psi)



SKF Adapter Block 226402

The adapter block SKF 226402 consists of a cast steel block to which a pressure gauge and high-pressure pipe can be connected. It comes with a floor support and a 90 degree connection nipple for the oil reservoir.

Technical data

Designation	226402
Maximum pressure	400 MPa (58 000 psi)
Pressure gauge connection	G1/2
Pressure pipe connection	G3/4
Weight	2,55 kg (5.6 lb)

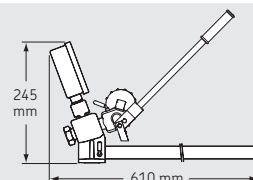

For bearing mounting

SKF Mounting Fluid LHM 300

SKF Mounting Fluid is suitable for use with SKF hydraulic equipment, including hydraulic pumps, HMV ..E nuts and oil injection tools. SKF LHM 300 contains anti-corrosives which are non-aggressive to seal materials such as nitrile rubber, perbunan, leather and chrome leather, PTFE, and so on.



For bearing dismounting

SKF Dismounting Fluid LHDF 900

SKF Dismounting Fluid is suitable for use with SKF hydraulic equipment, including hydraulic pumps and oil injection tools. SKF LHDF 900 contains anti-corrosives which are non-aggressive to seal materials such as nitrile rubber, perbunan, leather and chrome leather, PTFE, and so on.

Technical data

Designation	LHDF 900/pack size	LHM 300/pack size
Specific gravity	0,885	0,882
Flash point	202 °C (395 °F)	200 °C (390 °F)
Pour point	-28 °C (-18 °F)	-30 °C (-22 °F)
Viscosity at 20 °C (68 °F)	910 mm ² /s	300 mm ² /s
Viscosity at 40 °C (104 °F)	330 mm ² /s	116 mm ² /s
Viscosity at 100 °C (212 °F)	43 mm ² /s	17,5 mm ² /s
Viscosity index	180	160
Available pack size	5 and 205 litre	1, 5, 205 litre

Also available from SKF



Mounting bearings made easy

SKF Adapter and withdrawal sleeves for oil injection

These SKF sleeves facilitate the use of the SKF Oil Injection Method.

The larger sleeves have oil supply ducts and distribution grooves, enabling the user to inject oil between the sleeve and bearing bore and between the sleeve and the shaft. This oil reduces friction and force necessary for mounting, particularly when mounting in a dry state.

- Reduces the risk of damage to shaft and sleeve
- Reduces time to mount and dismount bearings
- A full range of pumps, nipples and pipes are available
- SKF sleeves also help make bearing dismounting easier

For more information, please refer to the SKF General Catalogue, the SKF Maintenance Handbook or consult an SKF application engineer.



The tool to monitor the mounting of SensorMount bearings

SensorMount indicator TMEM 1500

The SKF TMEM 1500 provides a direct reading of the fit of a “SensorMount” bearing mounted on a tapered seating.

The TMEM 1500 is only compatible with SKF bearings, which are fitted with the SensorMount sensor. These bearings from SKF have the designation suffixes ZE, ZEB, or ZEV, e.g. ZE 241/500 ECAK30/W33. The SensorMount Indicator provides a numeric value, which guides the user in achieving a reliable bearing fit. SKF bearings fitted with the SensorMount system can also be mounted on adapter sleeves, withdrawal sleeves and hollow shafts. The material composition of the shaft has no effect on the proper operation of the SensorMount system.

What you see is what you get; directly indicates the real reduction in internal bearing clearance.

- Easy to use
- Fast
- Reliable
- Simplifies the mounting process:
 - No calculations needed
 - Makes feeler gauges obsolete
 - Minimises the risk of human errors

Technical data

Designation	TMEM 1500
Range of measurement	0 to 1,500 μ m
Power supply	9 V alkaline battery, type IEC 6LR61
Battery life	8 hours, continuous use
Display	4-digit LCD with fixed decimal
Operating temperature range	-10 to +50 °C (14 to 122 °F)
Accuracy	±1%, ±2 digits
IP rating	IP 40
Weight	250 g (8.75 oz.)
Size	157 × 84 × 30 mm (6.1 × 3.3 × 1.8 in.)

OK Coupling mounting and dismounting kits

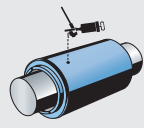
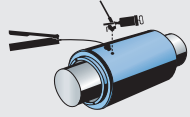
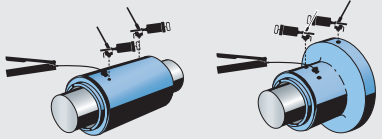
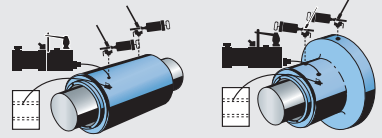
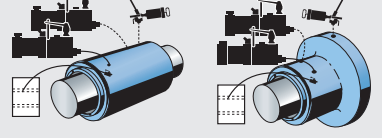
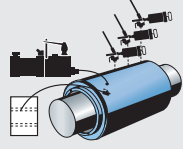
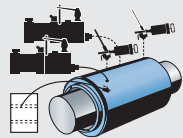
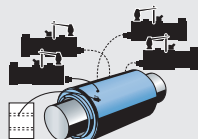
Coupling size	Designation	Contents	Weight	Application
OKC 45–OKC 90	TMHK 35	1 × 226400 E Injector with spares 1 × 226402 Adapter block 1 × 228027 E Nipple 1 × 729944 E Plug 1 × 227958A Pressure pipe (for OKC 80 and 90) 1 × 728017A/2000 Pressure pipe (for OKC 45–75) Tools and storage case	12 kg (26.5 lb)	
OKC 100–OKC 170 OKCS 178–OKCS 360	TMHK 36	1 × 226400 E Injector with spares 1 × TMJL 50 Hydraulic pump Tools and storage case	19 kg (41.8 lb)	
OKC 180–OKC 250 OKF 100–OKF 300	TMHK 37	2 × 226400 E Injector with spares 1 × 226402* Adapter block 1 × 227958A* High pressure pipe 1 × TMJL 50 Hydraulic pump Tools and storage case	28,1 kg (61.8 lb)	
* = for use with OKF couplings				
OKC 180–OKC 490 OKF 300–OKF 700 Shipboard or infrequent use	TMHK 38	1 × THAP 030E/SET Air-driven pump set 1 × 729147A Return hose 2 × 226400 E Injector with spares	36 kg (79.5 lb)	
OKC 180–OKC 490 OKF 300–OKF 700 Shipyard or frequent use	TMHK 38S	1 × THAP 030E/SET Air-driven pump set 1 × 729147A Return hose 1 × THAP 300E Air-driven oil injector 1 × 226400 E Injector with spares	81,7 kg (180 lb)	
OKC 500–OKC 600 Shipboard or infrequent use	TMHK 39	1 × THAP 030E/SET Air-driven pump 1 × 729147A Return hose 3 × 226400 E Injector with spares	38,6 kg (85 lb)	
OKC 500 and larger Shipboard or infrequent use	TMHK 40	1 × THAP 030E/SET Air-driven pump 1 × THAP 300E Air-driven pump 1 × 729147A Return hose 2 × 226400 E Injector with spares	84 kg (185 lb)	
OKC 500 and larger Shipyard or frequent use	TMHK 41	1 × THAP 030E/SET Air-driven pump 3 × THAP 300E Air-driven oil injector 1 × 729147A Return hose	136 kg (300 lb)	

Alignment

Introduction	74
SKF Shaft Alignment Tool TKSA 11	76
SKF Shaft Alignment Tool TKSA 31	77
SKF Shaft Alignment Tool TKSA 41	78
SKF Shaft Alignment Tool TKSA 51	79
SKF Shaft Alignment Tool TKSA 60	80
SKF Shaft Alignment Tool TKSA 80	80
SKF Machinery Shims TMAS series	84
SKF Vibracon	85
SKF TKBA Series	88

Basic condition monitoring

Introduction	90
SKF Thermometers	93
SKF Infrared Thermometer TKTL 10	94
SKF Infrared Thermometer TKTL 20	94
SKF Infrared Thermometer TKTL 30	94
SKF Infrared Thermometer TKTL 40	95
SKF K-type Thermocouple Probes TMDT 2 series	97
SKF Thermal Camera TKTI 21	98
SKF Thermal Camera TKTI 31	98
SKF Tachometer TKRT 10	102
SKF Tachometer TKRT 20	102
SKF Stroboscope TKRS 10	104
SKF Stroboscope TKRS 20	104
SKF Endoscopes TKES 10F	106
SKF Endoscopes TKES 10S	106
SKF Endoscopes TKES 10A	106
SKF Electronic Stethoscope TMST 3	108
SKF Sound Pressure Meter TMSP 1	109
SKF Ultrasonic Leak Detector TMSU 1	110
SKF Electrical Discharge Detector Pen TKED 1	111
SKF Machine Condition Indicator CMSS 200	112
SKF Machine Condition Advisor CMAS 100-SL	114
Inspector 400 Ultrasonic Probe CMIN 400-K	115

Instruments

Alignment	74
Basic condition monitoring	90



Alignment



Accurate shaft alignment really matters

Reduce machinery breakdowns and increase your uptime

It's a fact. Shaft misalignment is a major contributor to rotating machinery breakdowns. Accurately aligning shafts can prevent a large number of machinery breakdowns and reduce unplanned downtime that results in a loss of production. In today's challenging environment of reducing costs and optimising assets, the necessity of accurate shaft alignment is now greater than ever.

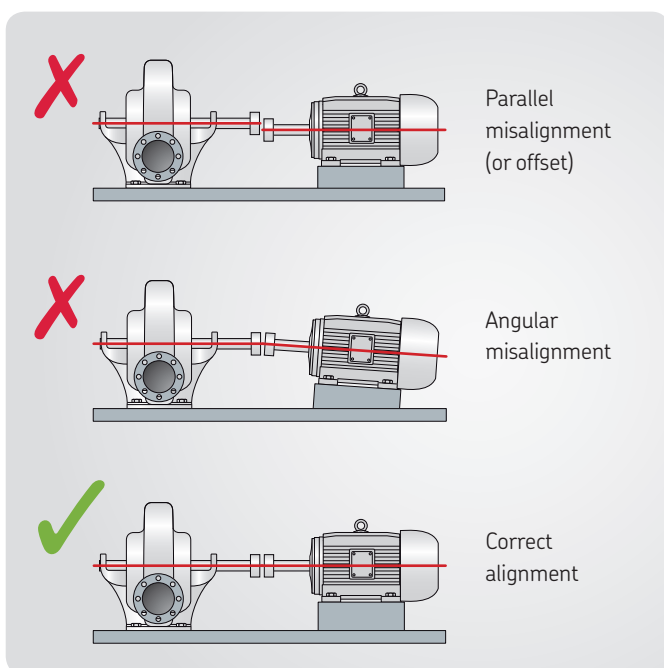

What is shaft misalignment?

Machines need to be aligned in both the horizontal and vertical plane. The misalignment can be caused by both parallel or angular misalignment. The possible consequences of shaft misalignment are serious to any company's bottom line and include:

- Increased friction and thereby energy consumption
- Premature bearing and seal failure
- Premature shaft and coupling failure
- Excessive seal lubricant leakage
- Failure of coupling and foundation bolts
- Increased vibration and noise



What methods can be used to align shafts?

In general, it's clear that laser alignment systems are quicker and easier to use than dial indicators, have better accuracy and don't require special skills to get accurate results virtually every time.

Which type of laser alignment system should be considered?

Before purchasing a system, identify the applications where it is to be used and make a list of requirements. Buying an expensive system that can accommodate virtually every need can be a costly mistake, as the technicians need to be skilled in using it.

The majority of alignment tasks consist of such things as a horizontally placed electric motor with a pump or fan with a single coupling. For such tasks, the technician needs a system that is quick and easy to use and doesn't need a long set up time.

What can SKF offer?

SKF has developed, after extensive consultation with users, a range of affordable, easy to use shaft alignment tools that are suitable for a majority of alignment tasks.

	Straight edge	Dial indicators	Laser shaft alignment
Accuracy	--	++	++
Speed	++	--	+
Ease of use	++	--	+

New technology makes shaft alignment easier and more affordable

SKF Shaft Alignment Tool TKSA 11

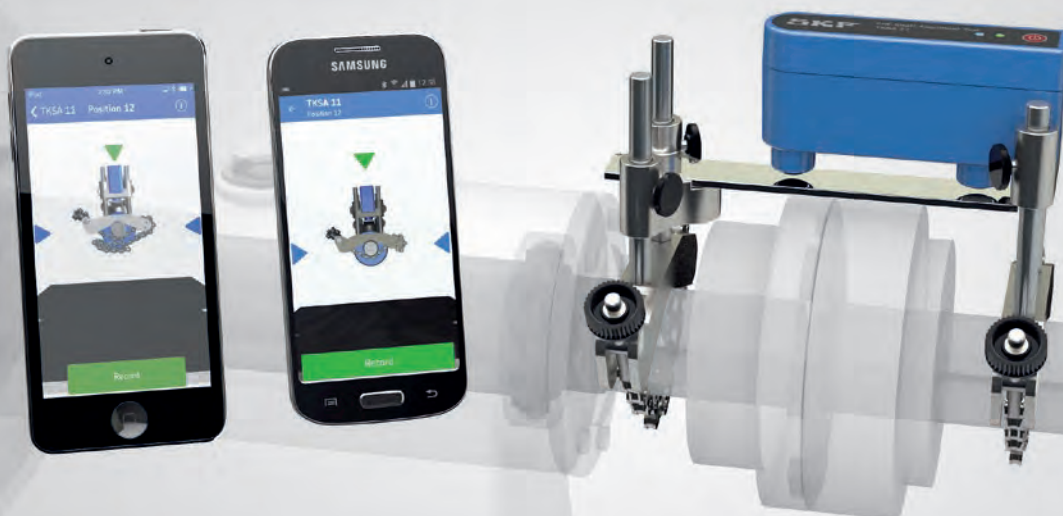

Mobile devices allow high resolution graphics, intuitive usage, automatic software updates and display unit choice.

The SKF TKSA 11 heralds a new generation of shaft alignment tools. Using mobile devices, the instrument intuitively guides the user through the whole alignment process. With a focus on the core alignment tasks, the TKSA 11 is designed to be a very easy-to-use instrument that results in accurate alignment and is especially suitable for entry level shaft alignment. The SKF TKSA 11 is the first instrument on the market that uses inductive proximity sensors, enabling accurate and reliable shaft alignment to be affordable for every budget.

- Live view of the instrument and motor position makes the measurement and horizontal alignment intuitive and easy.
- The TKSA 11 App offers a fully functional demonstration mode allowing the complete alignment process to be experienced without the need to purchase the TKSA 11.
- The TKSA 11 is designed to give a fast return on its investment and is also affordable for almost every budget.
- By using inductive proximity sensors, the measurement is no longer affected by bright sunlight, influence of backlash is reduced and the instrument becomes more robust. All enabling the TKSA 11 to deliver highly accurate and reliable alignments.
- Automatic alignment reports give a complete overview of the alignment process and results. Reports can easily be shared via email or cloud services.



The intuitive and affordable laser shaft alignment system

SKF Shaft Alignment Tool TKSA 31

The TKSA 31 is SKF's most affordable solution for easy laser shaft alignment. The ergonomic display unit with touch screen makes the instrument very easy to use and the built-in machine library helps storing alignment reports for multiple machines. Large sized laser detectors in the measuring heads reduce the need for pre-alignments and the embedded soft foot tool helps establish the foundation for a successful alignment. Additional functions such as live view and automatic measurement support fast and effective alignment tasks and make the TKSA 31 an innovative laser shaft alignment tool that is affordable for almost every budget.

- Easy measurements can be performed by using the well-known three position measurement (9-12-3 o'clock) with additional positioning flexibility of 40° around each measurement position.
- High affordability is achieved by focussing on the standard shaft alignment process and essential functions to allow quick and effective shaft alignments.
- "Automatic measurement" enables hands-free measurements by detecting the position of the heads and only taking a measurement when the heads are in the right position.
- Automatic reports are generated after each alignment and can be customised with notes about the application. All reports can be exported as pdf files.
- The machine library gives an overview of all machines and alignment reports. It simplifies the machine identification and improves the alignment workflow.



Live view supports intuitive measurements and facilitates horizontal and vertical machine position corrections.



The advanced laser shaft alignment system with enhanced measuring and reporting capabilities

SKF Shaft Alignment Tool TKSA 41



Free measurement allows alignment measurements to start at any angle and finish with an angular sweep of just 90°.



Machine library gives an overview of all machines and alignment reports.

The TKSA 41 is an advanced laser alignment solution for achieving accurate shaft alignments. With two wireless measurement units, large sized detectors and powerful lasers, the instrument performs precise measurements in even the most challenging conditions. The ergonomic display unit with intuitive touch screen navigation makes your alignments fast and easy, whilst innovative features, like the “free measurement”, increase the alignment performance. With the focus on improving alignment practices, the SKF Shaft Alignment Tool, TKSA 41, is one of the industry’s best value alignment solutions.

- Wireless communication improves instrument handling and allows alignments of difficult to reach applications from a safe position.
- Automatic measurement enables hands-free measurements by detecting the head position and taking a measurement when the heads are rotated into the right position.
- Automatic reports are generated after each alignment. The reports can be customised with notes and pictures from the built-in camera for the most comprehensive overview. All reports can be exported as pdf files.
- Live view supports intuitive measurements and facilitates horizontal and vertical alignments.
- The simplicity of the TKSA 41 provides greater confidence for the performance of alignment tasks on all types of horizontal rotating machines.
- QR codes can be used to further simplify machine identification and improve the alignment workflow.

Comprehensive and intuitive shaft alignment utilising tablets and smart phones

SKF Shaft Alignment Tool TKSA 51

The TKSA 51 shaft alignment tool provides high measurement flexibility and performance suitable for entry-level to expert alignment jobs. Designed to work with the shaft alignment for TKSA 51 app on a tablet or smart phone, this intuitive tool is easy to use and requires no special training. The included accessories enable use of the TKSA 51 for a wide range of alignment applications, such as motors, drives, fans, pumps, gearboxes and more. The tool's mobile app includes tutorial videos to show operators how to perform accurate measurements.

- **Measurement flexibility** - The well-known, three-position measurement gains additional flexibility as measurements can start at any angle and require a total minimal rotation of only 40 degrees. This enables operators to perform alignments on applications with limited space.
- **Automatic reports** - Alignment reports are generated automatically and can be customised with notes, a machine picture and a signature via touchscreen. These reports can be exported as PDF files and shared with other mobile apps.
- **Comprehensive and compact** - A range of included components, such as magnetic mounting brackets and extension rods and chains, increase the TKSA 51's versatility, yet it remains compact, lightweight and easy to carry.
- **3-D live view** - This feature enables intuitive positioning of heads for quick alignment measurements and displays live when horizontal/vertical alignment correction is achieved. The app enables 3-D rotation of the virtual motor to correspond with the actual machine position.
- **Disturbance compensation** - Measurement values are averaged over time to provide accuracy in presence of vibration or other external disturbances.
- **Fully functional demo mode** - The app can be downloaded easily, and its demonstration mode allows the shaft alignment process to be experienced before purchasing the TKSA 51.



Of the TKSA family of products, the TKSA 51 shaft alignment tool is suitable for the broadest range of applications. Its compact, lightweight design, high measurement flexibility and included accessories enable use of the instrument on virtually any machine, even in difficult-to-reach locations. Protective cases can be used on tablets and smart phones and do not affect the functionality of the TKSA 51.



TKSA 60

The wireless laser shaft alignment tool with built-in alignment expert.

The TKSA 60 is an extremely rugged wireless laser shaft alignment tool that can be used in harsh environments. The system provides instant expertise with a built-in step-by-step alignment process, from preparation, inspection and evaluation through correction, reporting and analysis. The system incorporates the latest alignment knowledge and decades of SKF experience of rotating equipment.

TKSA 80

The advanced laser shaft alignment tool to increase your alignment knowledge.

For effective machine alignment, the measurement is only 5% of the process. Users often find themselves encountering difficulties by skipping some important alignment steps. The TKSA 80 system has a complete built-in alignment process to increase users' knowledge of alignment. The programme takes users from preparation and evaluation all the way through to correction and finally a report of the result. With a 7 inch screen, the TKSA 80 can accommodate large machine train alignment jobs. It offers a unique database to store the machine set-up data for future use, visual inspections on oil leakage, oil level, foundation bolt status and wear indications.



Shaft alignment is recommended for almost every industry, as it enables machine uptime to be significantly improved and maintenance costs to be reduced.

	TKSA 11	TKSA 31	TKSA 41	TKSA 51	TKSA 60	TKSA 80
User interface Input and interaction with the display device.	iOS & Android	touch screen	touch screen	iOS	keypad	keypad & touchscreen
Measurement type The "9-12-3" measurement demands pre-defined measurement positions, whereas the "free" measurement allows free user selectable measurement positions.	9-12-3	9-12-3	free	free	free	free
Automatic measurement Alignment measurements can be performed hands-free without display unit interaction.		✓	✓	✓		
Wireless measuring heads	✓		✓	✓	✓	✓
Measurement distance Maximum possible distance between the brackets of the measuring heads.	18,5 cm	2 m*	4 m	5 m	10 m	10 m
Minimal shaft rotation Describes the minimal required total shaft rotation angle to perform alignment measurements.	180°	140°	90°	40°	60°	60°
Live positioning Electronic inclinometers show the angular position of the measuring heads, enabling easy and fast positioning.	✓	✓	✓	✓	✓	✓
Live alignment Live feet values are shown to facilitate the horizontal motor movement and vertical chock adjustment.	only horizontal	✓	✓	✓	✓	✓
Soft foot The soft foot tool helps to find and correct a soft foot, so that the machine can stand evenly on all feet.		✓	✓	✓**	✓	✓
Automatic report Reports are automatically generated after each alignment and can be exported as PDF files.	✓	✓	✓	✓	✓	✓
Camera Machine picture(s) can be taken and added to alignment reports.	✓		✓	✓		
Machine library Overview of all registered machines and previous alignment reports.		✓	✓		✓	✓
QR code recognition QR labels can be used to simplify the machine identification and increase the usage convenience.			✓			
Swap view Enables graphics to be rotated or swapped (from one side of the machine to the other) to accommodate the user position.	fixed angle	fixed angle	fixed angle	free 3D rotation	2D swap	2D swap
Target values Using target values for alignment, it is possible to compensate for thermal expansion or similar influences.				✓	✓	✓
Disturbance compensation Measurement values are averaged over time, allowing accurate measurements in the presence of vibration or similar external disturbances.				✓		
Vertical machine alignment Alignment of machines with vertical shafts.					✓	✓
Machine train alignment Enables the alignment of up to 5 machines in a line.						✓
Run-out check The system reminds users to perform a simple measurement to look for bent shafts.						✓

* With USB cables supplied ** With separate app: "Soft Foot for TKSA 51"

Technical data	TKSA 11	TKSA 31	TKSA 41
Measuring Unit(s)			
Sensors & communication	2x Inductive proximity sensors Inclinometer $\pm 0.5^\circ$, Bluetooth 4.0 LE	29 mm (1.1 in.) CCD with red line laser Class 2 Inclinometer $\pm 0.5^\circ$, Wired, USB cables	29 mm (1.1 in.) CCD with line laser Class 2 Inclinometer $\pm 0.5^\circ$; Bluetooth 4.0 LE and wired, USB cables
System measuring distance	0 to 185 mm (0 to 7.3 ft)	0,07 to 2 m (0.23 to 6.6 ft) Up to 4 m (13.1 ft) possible with longer cables	0,07 to 4 m (0.23 to 13.1 ft)
Measuring errors	<2%	<0,5% $\pm 5 \mu\text{m}$	< 0,5% $\pm 5 \mu\text{m}$
Housing material	PC/ABS plastic	20% Glass filled Polycarbonate	20% Glass filled Polycarbonate
Operating time	Up to 18 hours continuous operation, 1 900 mAh rechargeable LiPo battery	N/A	Up to 16 hours of continuous use, 2 000 mAh rechargeable LiPo battery
Dimensions	105 x 55 x 55 mm (4.1 x 2.2 x 2.2 in.)	120 x 90 x 36 mm (4.7 x 3.5 x 1.4 in.)	120 x 90 x 36 mm (4.7 x 3.5 x 1.4 in.)
Weight	155 g (0.34 lb)	180 g (0.4 lb)	220 g (0.5 lb)
Operating device			
Operating device	iPod touch 5th generation, iPhone 4S, iPhone 5, iPad mini, iPad 3rd generation or above. Galaxy S4, Galaxy Tab Active (all not included)	5.6" colour resistive touchscreen LCD display. High Impact PC/ABS with overmould	5.6" colour resistive touchscreen LCD display. High Impact PC/ABS with overmould
Software/App update	Apple AppStore or on Google Play Store	via USB stick	via USB stick
Operating system requirements	Apple iOS 8 or Android OS 4.4.2 (and above)	N/A	N/A
DU Operating time	N/A	7 hours of continuous use (100% backlight) 5 000 mAh rechargeable LiPo battery	8 hours of continuous use (100% backlight) 5 000 mAh rechargeable LiPo battery
Dimensions	N/A	205 x 140 x 60 mm (8.1 x 5.5 x 2.4 in.)	205 x 140 x 60 mm (8.1 x 5.5 x 2.4 in.)
Weight	N/A	420 g (0.9 lb)	640 g (1.4 lb)
Complete system			
Alignment method	Alignment of horizontal shafts 3 position measurement 9–12–3	Alignment of horizontal shafts 3 position measurement 9–12–3 (with min. 140° rotation), automatic measurement	Alignment of horizontal shafts 3 position measurement 9–12–3, automatic measurement, free measurement (with min. 90° rotation)
Live correction values	Only for horizontal	Vertical and horizontal	Vertical and horizontal
Soft foot correction	No	Laser soft foot	Laser soft foot
Extra features	No	Screen orientation flip	QR code reading, Screen orientation flip
Fixture	2x V-brackets with chains, width 15 mm (0.6 in.)	2x V-brackets with chains, width 21 mm (0.8 in.)	2x V-brackets with chains, width 21 mm (0.8 in.)
Shaft diameters	20 to 160 mm (0.8 to 6.3 in.)	20 to 150 mm (0.8 to 5.9 in.) 300 mm (11.8 in.) with optional extension chains (not included)	20 to 150 mm (0.8 to 5.9 in.) 300 mm (11.8 in.) with optional extension chains (not included)
Max. coupling height*	55 mm (2.2 in.)	105 mm (4.2 in.), 195 mm (7.7 in.) with optional extension rods (not included)	195 mm (7.7 in.)
Power adapter	Charging via micro USB port (5V) Micro USB to USB charging cable supplied Compatible with 5V USB chargers (not included)	Input: 100V–240V 50/60Hz AC power supplier Output: DC 12V 3A with EU, US, UK, AUS adapters	Input: 100V–240V 50/60Hz AC power supplier Output: DC 12V 3A with EU, US, UK, AUS adapters
Operating temperature	0 to 45 °C (32 to 113 °F)	0 to 45 °C (32 to 113 °F)	0 to 45 °C (32 to 113 °F)
IP rating	IP 54	IP 54	IP 54
Carrying case dimensions	355 x 250 x 110 mm (14 x 9.8 x 4.3 in.)	530 x 110 x 360 mm (20.9 x 4.3 x 14.2 in.)	530 x 110 x 360 mm (20.9 x 4.3 x 14.2 in.)
Total weight (incl. case)	2,1 kg (4.6 lb)	4,75 kg (10.5 lb)	4.75 kg (10.5 lb)
Calibration certificate	Supplied with 2 years validity	Supplied with 2 years validity	Supplied with 2 years validity
Warranty	2 years standard warranty +1 year upon registration	2 years standard warranty +1 year upon registration	2 years standard warranty +1 year upon registration
Case content	Measuring unit; 3 reference bars; 2 shaft brackets with chains 480 mm (18.9 in.) and rods 80 mm (3.1 in.); micro USB to USB charging cable; measuring tape 2 m (6.6 ft.); printed certificate of calibration and conformance; printed quick start guide (EN); SKF carrying case	2 measuring units (M&S); display unit; 2 shaft brackets with chains 400 mm (15.8 in.) and threaded rods 150 mm (5.9 in.); chain tightening rod; power supply with country adapters; 2 micro USB to USB cables; measuring tape; printed certificate of calibration and conformance; printed quick start guide (EN); SKF carrying case	2 measuring units (M&S); display unit; 2 shaft brackets with chains 400 mm (15.8 in.) and threaded rods 150 mm (5.9 in.); chain tightening rod; 4 threaded extension rods 90 mm (3.5 in.); power supply with country adapters; 2 micro USB to USB cables; measuring tape; printed certificate of calibration and conformance; printed quick start guide (EN); SKF carrying case

* Depending on the coupling, the brackets can be mounted on the coupling, reducing the coupling height limitation.

TKSA 51	TKSA 60	TKSA 80
20 mm (0.8 in.) PSD with line laser Class 2 Inclinometer ±0.1°; Bluetooth 4.0 LE	36 mm (1.4 in.) CCD with line laser Class 2 Inclinometer ±0.1°; Wireless 802.15.4	36 mm (1.4 in.) CCD with line laser Class 2 Inclinometer ±0.1°; Wireless 802.15.4
0,07 to 5 m (0.23 to 16.4 ft)	0,07 to 10 m (0.23 to 32.8 ft)	0,07 to 10 m (0.23 to 32.8 ft)
<1% ±10 µm	< 0,5% ±5 µm	< 0,5% ±5 µm
Anodized Aluminum front and PC/ABS plastic back cover	Aluminum chassis glass filled PBT	Aluminum chassis glass filled PBT
Up to 10 hours continuous use 2 000 mAh rechargeable Li-ion battery	Up to 8 hours continuous use 2× AA Alkaline batteries or rechargeable battery (NiMH)	Up to 8 hours continuous use 2× AA Alkaline batteries or rechargeable battery (NiMH)
52 × 64 × 50 mm (2.1 × 2.5 × 2 in.)	96 × 93 × 36 mm (3.8 × 3.7 × 1.4 in.)	96 × 93 × 36 mm (3.8 × 3.7 × 1.4 in.)
190 g (0.4 lb)	326 g (0.7 lb)	326 g (0.7 lb)
iPad Mini recommended, iPad 3rd generation or above iPod Touch 5th generation, iPhone 4S or above (all not included)	4.3" colour LCD display High impact PC/ABS plastic	7" colour resistive touchscreen LCD display with keypad. High impact PC/ABS plastic
Apple AppStore or on Google Play Store	via PC / USB stick	via PC / USB stick
Apple iOS 8 or Android OS 4.4.2 (and above)	N/A	N/A
N/A	10 hours of continuous use (100% backlight) Li-ion rechargeable battery	10 hours of continuous use (100% backlight) Li-ion rechargeable battery
N/A	234 × 132 × 48 mm (9.2 × 5.2 × 1.9 in.)	276 × 160 × 53 mm (9.2 × 5.2 × 1.9 in.)
N/A	680 g (1.5 lb)	1 060 g (2.4 lb)
Alignment of horizontal shafts 3 position measurement 9–12–3, automatic measurement, free measurement (with min. 40° rotation)	Alignment of horizontal and vertical shafts 3 position measurement 9–12–3, free measurement (with min. 60° rotation)	Alignment of horizontal and vertical shafts 3 position measurement 9–12–3, free measurement (with min. 60° rotation)
Vertical and horizontal	Vertical and horizontal	Vertical and horizontal
Soft Foot App	Laser soft foot & Feeler gauge inspection	Laser soft foot & Feeler gauge inspection
Target values, Screen flip (plus portrait on tablets)	Target values, inspections	Target values, inspections, machine train alignment
2x V-brackets with chains, width 15 mm (0.6 in.)	2x V-brackets with chains, width 21 mm (0.8 in.)	2x V-brackets with chains, width 21 mm (0.8 in.)
20 to 150 mm (0.8 to 5.9 in.) 450 mm (17.7 in.) with extension chains (included)	20 to 150 mm (0.8 to 5.9 in.) 300 mm (11.8 in.) with extension chains (included)	20 to 150 mm (0.8 to 5.9 in.) 300 mm (11.8 in.) with extension chains (included)
170 mm (6.7 in.)	195 mm (7.7 in.)	195 mm (7.7 in.)
Charging via micro USB port (5V) Micro USB to USB split charging cable supplied Compatible with 5V USB chargers (not included)	Input: 100V–240V 50/60Hz AC power supplier Output: DC 12V 3A with EU, US, UK, AUS adapters	Input: 100V–240V 50/60Hz AC power supplier Output: DC 12V 3A with EU, US, UK, AUS adapters
0 to 45 °C (32 to 113 °F)	–10 to +50 °C (14 to 122 °F)	–10 to +50 °C (14 to 122 °F)
IP 54	IP 65	IP 65
355 × 250 × 110 mm (14 × 9.8 × 4.3 in.)	540 × 200 × 410 mm (21.3 × 7.9 × 16.1 in.)	540 × 200 × 410 mm (21.3 × 7.9 × 16.1 in.)
2,9 kg (6.4 lb)	7,3 kg (16.1 lb)	7,64 kg (16.84 lb)
Supplied with 2 years validity	Supplied with 1 years validity	Supplied with 1 years validity
2 years standard warranty +1 year upon registration	1 year standard warranty (Product Support Plan available)	1 year standard warranty (Product Support Plan available)
2 measuring units (M&S); 2 shaft brackets with chains 480 mm (18.9 in.), threaded rods 80 mm (3.2 in.) and magnets; chain tightening rod; 4 threaded extension rods 120 mm (4.7 in.); 2 extension chains 980 mm (38.6 in.); micro USB to USB split charging cable; measuring tape; printed certificate of calibration and conformance; quick start guide (EN); SKF carrying case	2 measuring units (M&S); display unit; 2 shaft brackets with chains 400 mm (15.8 in.) and threaded rods 150 mm (5.9 in.); chain tightening rod; 4 extension rods 90 mm (3.5 in.); power supply with country adapters; USB cable; measuring tape; screw driver; CD with instructions for use; printed certificate of calibration and conformance; quick start guide (EN); carrying case	2 measuring units (M&S); display unit; 2 shaft brackets with chains 400 mm (15.8 in.) and threaded rods 150 mm (5.9 in.); chain tightening rod; 4 extension rods 90 mm (3.5 in.); power supply with country adapters; USB cable; measuring tape; screw driver; CD with instructions for use; printed certificate of calibration and conformance; quick start guide (EN); carrying case

Note: Additional accessories are available such as extension chains, extension rods, sliding brackets, magnetic brackets, offset brackets. More information about spare parts and accessories can be found in the instructions for use. Please contact SKF or your authorised SKF distributors for more details.

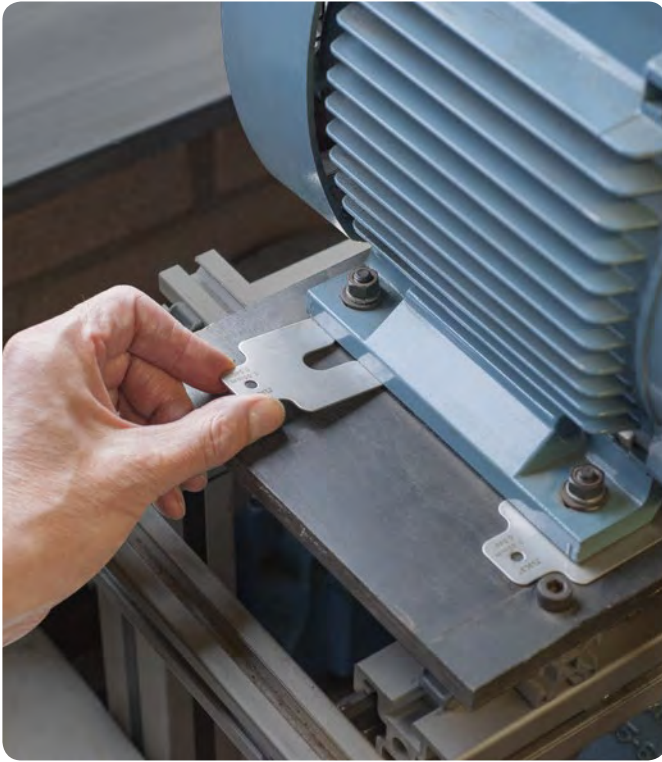

For accurate vertical machinery alignment

SKF Machinery Shims TMAS series

Accurate machine adjustment is an essential element of any alignment process. SKF single slot pre-cut shims are available in five different dimensions and in ten different thicknesses.

- Made of high quality stainless steel, allowing re-use
- Easy to fit and to remove
- Close tolerances for accurate alignment
- Thickness clearly marked on each shim
- Fully de-burred
- Pre-cut shims are supplied in packs of 10 and complete kits are also available



Dimensions

Designation	Number of shims per set	A	B	C	Thickness	Designation	Number of shims per set	A	B	C	Thickness
		mm	mm	mm	mm			mm	mm	mm	mm
TMAS 50-005	10	50	50	13	0,05	TMAS 75-005	10	75	75	21	0,05
TMAS 50-010	10	50	50	13	0,10	TMAS 75-010	10	75	75	21	0,10
TMAS 50-020	10	50	50	13	0,20	TMAS 75-020	10	75	75	21	0,20
TMAS 50-025	10	50	50	13	0,25	TMAS 75-025	10	75	75	21	0,25
TMAS 50-040	10	50	50	13	0,40	TMAS 75-040	10	75	75	21	0,40
TMAS 50-050	10	50	50	13	0,50	TMAS 75-050	10	75	75	21	0,50
TMAS 50-070	10	50	50	13	0,70	TMAS 75-070	10	75	75	21	0,70
TMAS 50-100	10	50	50	13	1,00	TMAS 75-100	10	75	75	21	1,00
TMAS 50-200	10	50	50	13	2,00	TMAS 75-200	10	75	75	21	2,00
TMAS 50-300	10	50	50	13	3,00	TMAS 75-300	10	75	75	21	3,00
TMAS 100-005	10	100	100	32	0,05	TMAS 125-005	10	125	125	45	0,05
TMAS 100-010	10	100	100	32	0,10	TMAS 125-010	10	125	125	45	0,10
TMAS 100-020	10	100	100	32	0,20	TMAS 125-020	10	125	125	45	0,20
TMAS 100-025	10	100	100	32	0,25	TMAS 125-025	10	125	125	45	0,25
TMAS 100-040	10	100	100	32	0,40	TMAS 125-040	10	125	125	45	0,40
TMAS 100-050	10	100	100	32	0,50	TMAS 125-050	10	125	125	45	0,50
TMAS 100-070	10	100	100	32	0,70	TMAS 125-070	10	125	125	45	0,70
TMAS 100-100	10	100	100	32	1,00	TMAS 125-100	10	125	125	45	1,00
TMAS 100-200	10	100	100	32	2,00	TMAS 125-200	10	125	125	45	2,00
TMAS 100-300	10	100	100	32	3,00	TMAS 125-300	10	125	125	45	3,00
TMAS 200-005	10	200	200	55	0,05						
TMAS 200-010	10	200	200	55	0,10						
TMAS 200-020	10	200	200	55	0,20						
TMAS 200-025	10	200	200	55	0,25						
TMAS 200-040	10	200	200	55	0,40						
TMAS 200-050	10	200	200	55	0,50						
TMAS 200-070	10	200	200	55	0,70						
TMAS 200-100	10	200	200	55	1,00						
TMAS 200-200	10	200	200	55	2,00						
TMAS 200-300	10	200	200	55	3,00						

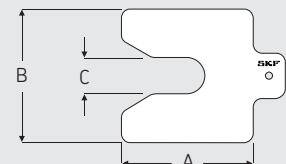



* Consists of TMAS 340 + TMAS 380

Designation	Size (mm)	Thickness (mm)								
		0,05	0,10	0,20	0,25	0,40	0,50	0,70	1,00	2,00
TMAS 50/KIT	50 × 50	20	20	20	20	20	20	20	20	10
TMAS 75/KIT	75 × 75	20	20	20	20	20	20	20	20	10
TMAS 100/KIT	75 × 75	20	20	20	20	20	20	20	20	10
TMAS 340	100 × 100	20	20	20	20	20	20	20	20	10
	125 × 125	20	20	20	20	20	20	20	20	10
TMAS 360	50 × 50	20	20	–	20	–	20	–	20	20
	75 × 75	20	20	–	20	–	20	–	20	20
	100 × 100	20	20	–	20	–	20	–	20	20
TMAS 380	50 × 50	20	20	20	20	20	20	20	20	20
	75 × 75	20	20	20	20	20	20	20	20	20
TMAS 510	50 × 50	20	20	20	20	20	20	20	20	10
	75 × 75	20	20	20	20	20	20	20	20	10
	100 × 100	20	20	20	20	20	20	20	20	10
TMAS 720 *	50 × 50	20	20	20	20	20	20	20	20	20
	75 × 75	20	20	20	20	20	20	20	20	20
	100 × 100	20	20	20	20	20	20	20	20	10
	125 × 125	20	20	20	20	20	20	20	20	10



The universal adjustable chock

SKF Vibracon

SKF Vibracon elements are machinery mounting chocks that are easily and accurately adjusted.

The elements accommodate the angular difference between machine and the mounting base without expensive machining of the base or the extra work of installing epoxy resin chocks. The self-leveling capability, combined with the height adjustment feature, eliminates the possibility of a soft foot in the production line through the life cycle of the machinery.

For additional information, please refer to our publication 6686 EN, or online at: machinesupport.com/vibracon



SKF Belt Alignment Tools

One of the common reasons for unplanned downtime of belt-driven machinery is pulley misalignment. Pulley misalignment can increase wear on pulleys and belts as well as increasing the noise and vibration level, that can result in unplanned machinery downtime. Another side effect of increased vibration is premature bearing failure. This too can cause unplanned machinery downtime.

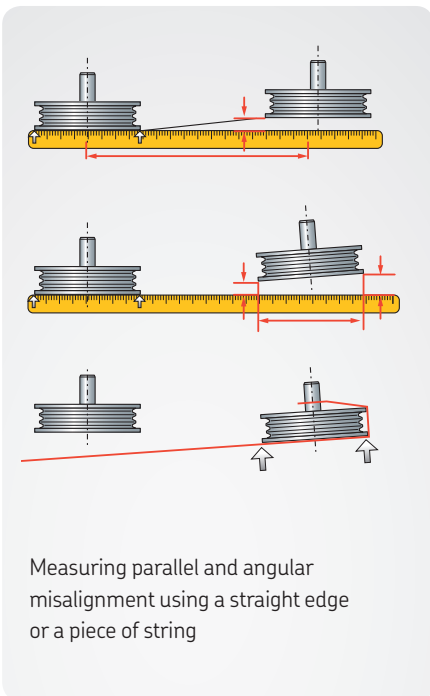

Traditional belt alignment methods

These methods are usually visual in combination with a straight edge and/or length of string. Although quick to perform, they are often inaccurate.

Laser belt alignment methods

Using a laser belt alignment tool is quicker and more accurate than traditional methods. Belt alignment tools can either align the pulley faces or the pulley grooves.

Accurate pulley and belt alignment can help you:

- Increase bearing life
- Increase machinery uptime, efficiency and productivity
- Reduce wear on pulleys and belts
- Reduce friction and thereby energy consumption
- Reduce noise and vibration
- Reduce costs of replacing components and machinery downtime

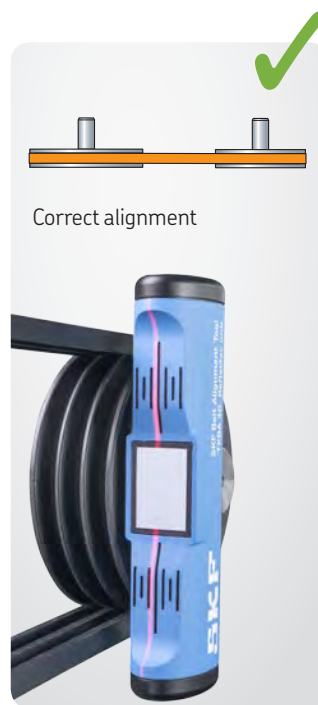

Belt-driven machinery downtime caused by misalignment is a thing of the past

SKF TKBA Series

SKF offers a range of three different belt alignment tools to enable accurate alignment for almost all applications. The tools are designed to be easy to use without any special training. The laser position indicates the nature of misalignment allowing easy and accurate adjustment.



	TKBA 10	TKBA 20	TKBA 40
Easy of use and accuracy with V-belt pulleys	●	●	●●
Use on other pulley types and chain sprockets	●●	●●	Optional side adapter TMEB A2 required
Max distance	3 m (10 ft)	6 m (20 ft)	6 m (20 ft)
Use in sunny environments	–	●●	–
Use with aluminium pulleys & sprockets	Use G clamp – to fix on face	Use G clamp – to fix on face	Not recommended
Application suitability	If versatility is required (e.g. V-belts and/or other belts and/or chain sprockets) choose TKBA 10 or 20		If mostly used with V belt applications choose TKBA 40





TKBA 10 and TKBA 20

Versatile tools for pulley and sprocket alignment

The SKF TKBA 10 and TKBA 20 allow pulleys and sprockets to be aligned on the side face. The unit magnetically attaches to the inside or outside face of almost any belt pulley or chain sprocket and has no small parts or targets that can get lost. A laser line is projected from the transmitter unit to the reflector unit mounted on the opposite pulley. A reference line on the reflector unit directly indicates the offset and vertical angle misalignment. The reflected laser line shown on the transmitter unit shows the horizontal angle misalignment of all three.

- Powerful magnets allow fast and easy attachment
- Facilitates simultaneous adjustment of tension and alignment
- Can be used on almost all machines using V belts, banded belts, ribbed belts and most other belts as well as chain sprockets
- SKF TKBA 10 utilises a red laser and can be used for distances up to 3 m (10 ft)
- SKF TKBA 20 utilises a highly visible green laser and can be used for distances up to 6 m (20 ft). It can even be used outdoors in sunny conditions
- Sturdy aluminium housings help ensure assembly stability and accuracy during the alignment process



TKBA 40

Highly accurate tool for V-belt pulley alignment

The SKF TKBA 40 aligns V-belt pulleys in the grooves. V-guides and powerful magnets allow the TKBA 40 to be fitted in the grooves of the pulley. With only two components, a laser-emitting unit and a receiver unit, the belt alignment tool is easy and fast to attach. The three-dimensional target area on the receiver unit allows the easy detection of misalignment as well as its nature; whether it is horizontal, vertical, parallel or a combination of all three.

- Powerful magnets allow fast and easy attachment
- Three-dimensional target area simplifies the alignment process
- Facilitates simultaneous adjustment of tension and alignment
- V-guides facilitate the alignment of a wide range of V-belt pulleys
- Aligns grooves of a V-belt pulley rather than its face, allowing optimum alignment of pulleys of unequal width or with dissimilar faces
- A maximum operating distance of 6 m (20 ft) accommodates many applications
- Special side adaptor allowing alignment of multi-ribbed and timing belt pulleys as well as sprockets is available as accessory

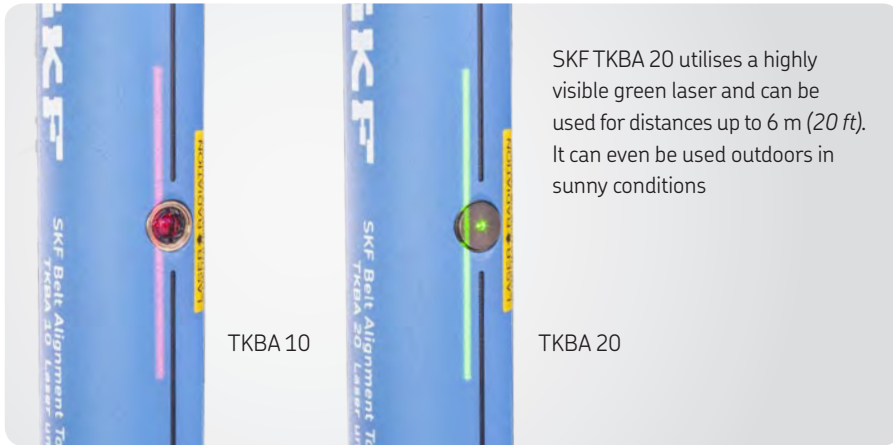

SKF TKBA 20 utilises a highly visible green laser and can be used for distances up to 6 m (20 ft). It can even be used outdoors in sunny conditions

TKBA 10

TKBA 20

SKF Belt Frequency Meter



For additional information, please refer to our publications 6479 EN or online at: www.skfptp.com

Technical data

Designation	TKBA 10	TKBA 20	TKBA 40
Type of laser	Red laser diode	Green laser diode	Red laser diode
Laser	1× Built-in class 2 laser, <1 mW, 635 nm	1× Built-in class 2 laser, <1 mW, 532 nm	1× Built-in class 2 laser, <1 mW, 632 nm
Laser line length	2 m at 2 m (6.6 ft at 6.6 ft)	2 m at 2 m (6.6 ft at 6.6 ft)	3 m at 2 m (9.8 ft at 6.6 ft)
Measurement accuracy angular	Better than 0,02° at 2 m (6.6 ft)	Better than 0,02° at 2 m (6.6 ft)	Better than 0,2°
Measurement accuracy offset	Better than 0,5 mm (0.02 in.)	Better than 0,5 mm (0.02 in.)	Better than 0,5 mm (0.02 in.)
Measurement distance	50 mm to 3 000 mm (2 in. to 10 ft)	50 mm to 6 000 mm (2 in. to 20 ft)	50 mm to 6 000 mm (2 in. to 20 ft)
Control	Laser on/off rocker switch	Laser on/off rocker switch	Laser on/off switch
Housing material	Aluminum, powder coat finish	Aluminum, powder coat finish	Extruded aluminium
Dimensions			
Transmitter unit	169 × 51 × 37 mm (6.65 × 2.0 × 1.5 in.)	169 × 51 × 37 mm (6.65 × 2.0 × 1.5 in.)	70 × 74 × 61 mm (2.8 × 2.9 × 2.4 in.)
Receiver unit	169 × 51 × 37 mm (6.5 × 2.0 × 1.5 in.)	169 × 51 × 37 mm (6.5 × 2.0 × 1.5 in.)	96 × 74 × 61 mm (3.8 × 2.9 × 2.4 in.)
Reflector dimensions	22 × 32 mm (0.9 × 1.3 in.)	22 × 32 mm (0.9 × 1.3 in.)	N/A
Weight			
Transmitter unit	365 g (0.8 lb)	365 g (0.8 lb)	320 g (0.7 lb)
Receiver unit	340 g (0.7 lb)	340 g (0.7 lb)	270 g (0.6 lb)
Mounting	Magnetic, side mounted	Magnetic, side mounted	Magnetic, groove mounted (optional side adapter TMEB A2)
V-guides	N/A	N/A	Size 1: 22 mm, short rods (3× pairs) Size 2: 22 mm, long rods (3× pairs) Size 3: 40 mm, short rods (3× pairs) Size 4: 40 mm, long rods (3× pairs)
Battery	2× AAA Alkaline type IEC LR03	2× AAA Alkaline type IEC LR03	2× AAA Alkaline type IEC LR03
Operation time	25 hours continuous operation	8 hours continuous operation	20 hours continuous operation
Carrying case dimensions	260 × 85 × 180 mm (10.2 × 3.3 × 7.1 in.)	260 × 85 × 180 mm (10.2 × 3.3 × 7.1 in.)	260 × 85 × 180 mm (10.2 × 3.3 × 7.1 in.)
Total weight (incl. case)	1,3 kg (2.9 lb)	1,3 kg (2.9 lb)	1,2 kg (2.7 lb)
Operating temperature	0 to 40 °C (32 to 104 °F)	0 to 40 °C (32 to 104 °F)	0 to 40 °C (32 to 104 °F)
Storage temperature	-20 to +60 °C (-4 to +140 °F)	-20 to +60 °C (-4 to +140 °F)	-20 to +65 °C (-4 to +150 °F)
Relative humidity	10 to 90% RH non-condensing	10 to 90% RH non-condensing	10 to 90% RH non-condensing
IP rating	IP 40	IP 40	IP 40
Calibration certificate	Valid for two years	Valid for two years	Valid for two years
Case contents	1× TKBA 10 transmitter unit 1× TKBA 10 receiver unit 2× AAA batteries 1× Printed instructions for use 1× Calibration certificate	1× TKBA 20 transmitter unit 1× TKBA 20 receiver unit 2× AAA batteries 1× Printed instructions for use 1× Calibration certificate	1× TKBA 40 transmitter unit 1× TKBA 40 receiver unit 2× AA batteries 4× sizes of V-guides, 3× of each size 1× Printed instructions for use 1× Calibration certificate

Basic condition monitoring

Basic condition monitoring is essential for achieving maximum bearing service life

To help ensure long bearing service life, it is important to determine the condition of machinery and bearings while in operation. Good predictive maintenance will help reduce machine downtime and decrease overall maintenance costs.

To help you achieve the maximum service life from your bearings, SKF has developed a wide range of instruments for analysing the critical environmental conditions which have an impact on bearing and machine performance.

Maintenance concepts

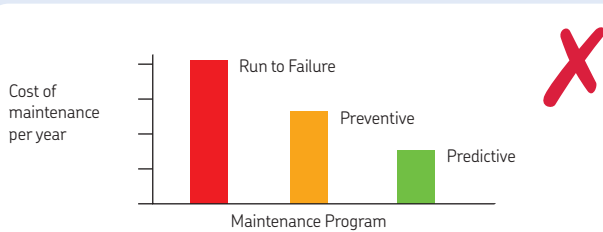

Maintenance cost comparisons.

Run to failure

Run to failure occurs when repair action is not taken until a problem results in machine failure. Run to failure problems often cause costly secondary damage along with unplanned downtime and maintenance costs.

August						
1	2	3	4	5	6	
7	8	9	10	11	12	
13	14	15	16	17	18	
19	20	21	22	23	24	
25	26	27	28	29	30	

Preventive maintenance is similar to the regular service of a car. Often, unnecessary maintenance is performed.

Preventive maintenance

Preventive maintenance implies that a machine, or parts of a machine, are overhauled on a regular basis regardless of the condition of the parts. While preferable to run to failure maintenance, preventive maintenance is costly because of excessive downtime from unnecessary overhauls and the cost of replacing good parts along with worn parts.

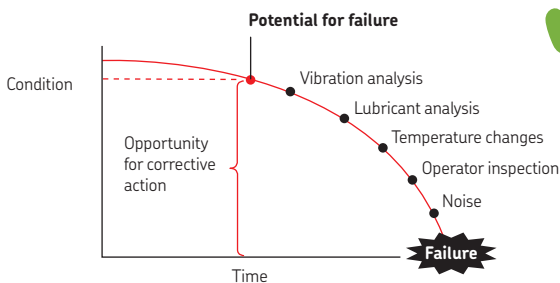

Condition based maintenance means repairs are only carried out when required.

Predictive maintenance

Condition monitoring/predictive maintenance is the process of determining the condition of machinery while in operation. This enables the repair of problem components prior to failure. Condition monitoring not only helps plant personnel reduce the possibility of catastrophic failure, but also allows them to order parts in advance, schedule manpower, and plan other repairs during the downtime. With condition monitoring, machinery analysis takes two overlapping forms: predictive and diagnostic.

SKF has developed a comprehensive range of basic condition monitoring tools suitable for Operator Driven Reliability (ODR) and maintenance technicians. Under ODR, some maintenance practices are owned, managed, and performed by operators. Often, the operators are the best persons equipped for basic inspection activities, as they know their part of the plant very well. They are often sensitive to minor changes in sounds and vibrations that may not be apparent to someone lacking their front-line experience.

Subsequently, minor defects can be corrected quickly, as the operator can undertake simple adjustment and repair tasks.

Maintenance technicians also have need for basic condition monitoring tools. If, for example, abnormal vibrations are detected or if an operator reports an abnormal running condition, then the technician can often use some basic condition monitoring tools to detect the root cause for further evaluation.

SKF basic condition monitoring tools can be used to check a number of properties:



Temperature

Since the dawn of the industrial age, operators and technicians know that abnormal temperatures often indicate that something is wrong with the machine. Such instruments as thermometers and thermal imagers can help find and then measure these hotspots, allowing further analysis to be conducted.



Speed

Machines are usually designed to run at a given speed. If the speed is too slow or too fast, then the overall process can be compromised. Using a hand-held tachometer enables a quick and easy assessment of the machine's running speed.



Visual

Visual inspection of a machine's condition can sometimes be difficult when it's running or when there is a need to inspect the machine internally. A stroboscope can be used to visually freeze the motion of a machine to allow such things as fan blades, couplings and belt drives to be inspected while running.

To inspect the internal parts of a machine often requires disassembly. By using an endoscope, it is possible to access the area of interest with minimal disassembly, saving time and money.



Sound

Abnormal sounds from machines often indicate that something is wrong. A stethoscope can be used to help pinpoint the source of the sound and can aid the technician in identifying the problem. Leaks in compressed air systems are costly, not only in energy costs but also due to extra costs in air compressor maintenance. Ultrasonic leak detectors can help detect leaks efficiently, allowing the necessary repairs to be made. Excessive noise can cause worker fatigue, increased accidents and loss of hearing. A sound pressure meter can measure the sound level, allowing corrective measures to be made.



Electrical discharge currents

Electrical discharges are a result of motor shaft voltages discharging to earth through the bearing, causing electrical erosion, lubricant degradation and ultimately bearing failure. An electrical discharge detector can help detect the presence of electrical discharge currents, allowing remedial action to be taken.

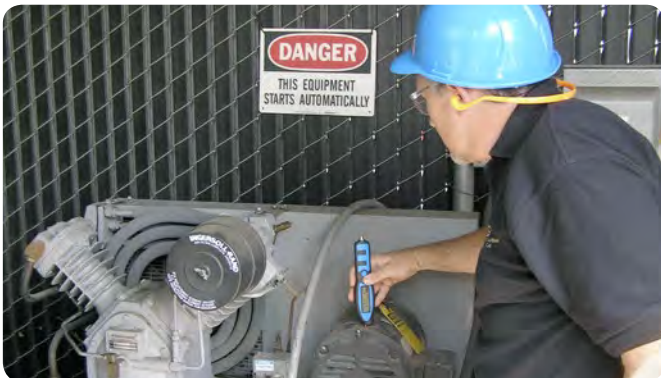

Vibration

Abnormal vibrations are often the first indication of a potential machine failure. These vibrations can be caused by such conditions as unbalance, misalignment, looseness of parts, rolling element bearing and gear damage. Vibration analysis instruments and systems, can help detect many serious problems at an early stage, allowing remedial work to be undertaken in a timely manner.



Lubricant condition

To maintain the optimum condition of rolling element bearings, it is essential that the lubricant is in good condition. Checking the oil or grease condition at regular intervals can reduce downtime and greatly prolong the life of rolling element bearings.

SKF Thermometers

SKF Thermometers are suitable for a wide range of applications. The pocket sized SKF TMTP 200 is a user friendly instrument with a sturdy flexible probe tip enabling many surface temperatures to be measured. The SKF TKDT 10 has a wide temperature measurement range and has the option to accommodate up to two SKF temperature probes.



TMTP 200

- Compact, ergonomic design
- Flexible probe tip for better surface contact, providing high measuring accuracy
- Maximum temperature function allows temperature peak hold
- Auto power off function with very low power consumption

TKDT 10

- Large back-lit LCD display
- Can be used with an optional second SKF temperature probe enabling either probe temperature, or the temperature difference between the probes, to be displayed.
- Can be used with an optional second SKF temperature probe enabling either probe temperature, or the temperature difference between the probes, to be displayed.
- Temperature display can be frozen for ease of reading
- User selectable auto power off function increases battery life

Technical data

Designation	TMTP 200	TKDT 10
Display	3 digit LCD	Large back-lit LCD
Displayed resolution	1° for the entire range	0,1 ° up to 1 000 °, otherwise 1°
Measurement modes	Max	Min, max, average, differential, dual temperature reading
Measurement units	°C, °F	°C, °F, K
Temperature using probe	-40 to +200 °C (-40 to +392 °F)	-200 to +1 372 °C (-328 to +2 501 °F)
Accuracy	±1,5 °C (2.7 °F) (acc. DIN IEC 584 class 1)	>-100 °C (>-148 °F): ±0.5% of reading ±1 °C (1.8 °F)
Probe compatibility	N/A	2× Type-K connectors
Probe supplied	Embedded K-type thermocouple (NiCr/NiAl)	TMDT 2-30, suitable for use up to 900 °C (1 650 °F)
Battery	3× AAAA Alkaline type IEC LR03	3× AAAA Alkaline type IEC LR03
Operation time	4 000 hours typical use	18 hours typical use (backlight on)
Product dimensions	165 × 50 × 21 mm (6.5 × 2 × 0.8 in.)	160 × 63 × 30 mm (6.3 × 2.5 × 1.2 in.)
Carrying case dimensions	260 × 85 × 180 mm (10.3 × 3.4 × 7.0 in.)	530 × 85 × 180 mm (20.9 × 3.4 × 7.0 in.)
Product weight	95 g (0.2 lb)	200 g (0.4 lb)

SKF Infrared thermometers

Infrared thermometers are portable, lightweight instruments for safely measuring temperature at a distance. They are extremely user-friendly; simply aim and pull the trigger and the temperature is shown on the display. These robust instruments are equipped with a back-lit display and laser sighting. They are fitted with a bright LED illuminator to allow the application object to be seen even in poorly lit environments.



TKTL 10

An infrared thermometer that's an essential tool for every technician

- Maximum temperature always shown; helps identify the real hotspots
- Auto shut off feature; helps optimise battery life
- Colour display with temperature trend indication



TKTL 20

An infrared and contact thermometer offering versatile temperature measurement options

- Supplied with temperature probe TMDT 2-30 (max. 900 °C (1 652 °F)); suitable for many direct contact applications
- Can be used with any SKF temperature probe
- User selectable, multiple temperature measurement modes including: maximum, minimum, average, differential and probe/infrared dual display, scan function
- User selectable high and low alarm levels with audible warning signal
- Mode dependant auto shut off feature optimises battery life
- Colour display with temperature trend indication



TKTL 30

An infrared and contact temperature thermometer with a wide measurement range and dual laser sighting

- Dual laser sighting feature defines the diameter of the area being measured; helps the user to precisely pin-point the temperature measurement area
- Supplied with temperature probe TMDT 2-30 (max. 900 °C (1 652 °F)); suitable for many direct contact applications
- Can be used with any SKF temperature probe
- User selectable, multiple temperature measurement modes including: maximum, minimum, average, differential and probe/infrared dual display, scan function
- User selectable high and level alarm levels with audible warning signal
- Mode dependant auto shut off feature optimises battery life



TKTL 40

An infrared and contact temperature thermometer with video and data logging capabilities

- Built-in camera allows pictures and videos, with all measurement information to be taken, stored, recalled and exported to PC
- Environmental properties such as ambient, dew point and wet-bulb temperatures, as well as relative humidity, can be displayed and stored
- Dual laser sighting defines the temperature measurement area



When used in non-contact mode, the thermometer senses the thermal energy radiated from an object with an infrared detector. When pointed at an object, the infrared detector collects energy, producing a signal that the microprocessor translates as a reading on the backlit display.

As the trigger is squeezed, the object temperature is continuously measured by the infrared detector. This allows for fast and accurate realtime readings.

- Supplied with temperature probe TMDT 2-30 (max. 900 °C (1 652 °F)) for direct contact applications. Can also be used with any other SKF temperature probe
- User selectable, multiple temperature measurement modes including: maximum, minimum, average, differential and probe/infrared dual display
- Data logging function can be used to visualise temperature changes over time
- User selectable high and low alarm levels with audible warning signal
- User selectable auto shut off feature optimises the rechargeable battery life

	TKTL 10	TKTL 20	TKTL 30	TKTL 40
Temperature range using infrared	-60 to +625 °C (-76 to +1 157 °F)	-60 to +625 °C (-76 to +1 157 °F)	-60 to +1 000 °C (-76 to +1 832 °F)	-50 to +1 000 °C (-58 to +1 832 °F)
Temperature range using probe	-	-64 to +1 400 °C (-83 to +1 999 °F)	-64 to +1 400 °C (-83 to +1 999 °F)	-50 to +1 370 °C (-58 to +2 498 °F)
Distance to spot size	16:1	16:1	50:1	50:1
Emissivity	Pre-set 0,95	0,1-1,0	0,1-1,0	0,1-1,0

Technical data

Designation	TKTL 10	TKTL 20	TKTL 30	TKTL 40
Probe supplied	–	TMDT 2-30, suitable for use up to 900 °C (1 650 °F)	TMDT 2-30, suitable for use up to 900 °C (1 650 °F)	TMDT 2-30, suitable for use up to 900 °C (1 650 °F)
Full range accuracy	$T_{obj} = 0$ to 625 °C $\pm 2\%$ of reading or 2 °C (4 °F) whichever is greater	$T_{obj} = 0$ to 635 °C $\pm 2\%$ of reading or 2 °C (4 °F) whichever is greater	$\pm 2\%$ of reading or 2 °C (4 °F) whichever is greater	20 to 500 °C: $\pm 1\%$ of reading or 1 °C (1.8 °F) whichever is greater 500 to 1 000 °C: $\pm 1,5\%$ of reading –50 to +20 °C: $\pm 3,5$ °C (6.3 °F)
Environmental limits	Operation 0 to 50 °C (32 to 122 °F) 10 to 95% relative humidity Storage –20 to +65 °C (–4 to +149 °F) 10 to 95% relative humidity	Operation 0 to 50 °C (32 to 122 °F) 10 to 95% relative humidity Storage –20 to +65 °C (–4 to +149 °F) 10 to 95% relative humidity	Operation 0 to 50 °C (32 to 122 °F) 10 to 95% relative humidity Storage –20 to +65 °C (–4 to +149 °F) 10 to 95% relative humidity	Operation 0 to 50 °C (32 to 122 °F) 10 to 95% relative humidity Storage –10 to +60 °C (14 to 150 °F) 10 to 95% relative humidity
Response time (90%)	<1 000 ms	<1 000 ms	<1 000 ms	<300 ms
LCD display resolution	0,1 °C/F from –9,9 to –199,9 otherwise 1 °C/F	0,1 °C/F from –9,9 to –199,9 otherwise 1 °C/F	0,1 °C/F from –9,9 to –199,9 otherwise 1 °C/F	0,1 ° up to 1 000 °, otherwise 1 °
Spectral response	8–14 μm	8–14 μm	8–14 μm	8–14 μm
User selectable backlight display	No, permanently on	On/Off	On/Off	No, permanently on
User selectable laser pointer	No, permanently on	On/Off	On/Off	On/Off
Measurement modes	Max temperature	Max, min, average, differential, probe/IR dual temperature modes	Max, min, average, differential, probe/IR dual temperature modes	Max, min, average, differential, probe/IR dual temperature modes
Alarm modes	–	High and low level alarm level with warning bleep	High and low level alarm level with warning bleep	High and low level alarm level with audible alarm
Laser	Class 2	Class 2	Class 2	Class 2
Dimensions	195 × 70 × 48 mm (7.7 × 2.7 × 1.9 in.)	195 × 70 × 48 mm (7.7 × 2.7 × 1.9 in.)	203 × 197 × 47 mm (8.0 × 7.7 × 1.8 in.)	205 × 155 × 62 mm (8.1 × 6.1 × 2.4 in.)
Packaging	Carton box	Sturdy carrying case	Sturdy carrying case	Sturdy carrying case
Carrying case dimensions	–	530 × 85 × 180 mm (20.9 × 3.4 × 7.0 in.)	530 × 85 × 180 mm (20.9 × 3.4 × 7.0 in.)	530 × 85 × 180 mm (20.9 × 3.4 × 7.0 in.)
Weight	230 g (0.5 lb)	Total: 1 100 g (2.4 lb) TKTL 20: 230 g (0.50 lb)	Total: 1 300 g (2.9 lb) TKTL 30: 370 g (0.815 lb)	Total: 1 600 g (2.53 lb) TKTL 40: 600 g (1.32 lb)
Battery	2 × AAA Alkaline type IEC LR03	2 × AAA Alkaline type IEC LR03	2 × AAA Alkaline type IEC LR03	1 × Rechargeable Li-ion Battery
Battery lifetime	18 hours	18 hours	140 hours with laser and backlight off Otherwise 18 hours	4 hours continuous use
Auto switch off	Yes	User selectable	User selectable	User selectable
HVAC functionalities	–	–	–	Wet bulb, dew point, humidity, air temperature
Photo and video mode	–	–	–	640 × 480 camera, images (JPEG) and video (3 GP)
Memory/PC connection	–	–	–	310 MB internal memory. Expandable using micro SD memory card (8 GB max.) / mini USB cable



Technical data – Thermocouple probes

Probe type	K-type thermocouple (NiCr/NiAl) acc. IEC 584 Class 1
Accuracy	$\pm 1,5$ °C (2.7 °F) up to 375 °C (707 °F) $\pm 0,4\%$ of reading above 375 °C (707 °F)
Handle	110 mm (4.3 in.) long
Cable	1 000 mm (39.4 in.) spiral cable (excl. TMDT 2-31, -38, -39, 41)
Plug	K-type mini-plug (1 260-K)

SKF K-type Thermocouple Probes TMDT 2 series

For use with SKF Infrared Thermometers TKTL 20, TKTL 30 and TKTL 40

Dimensions (mm)

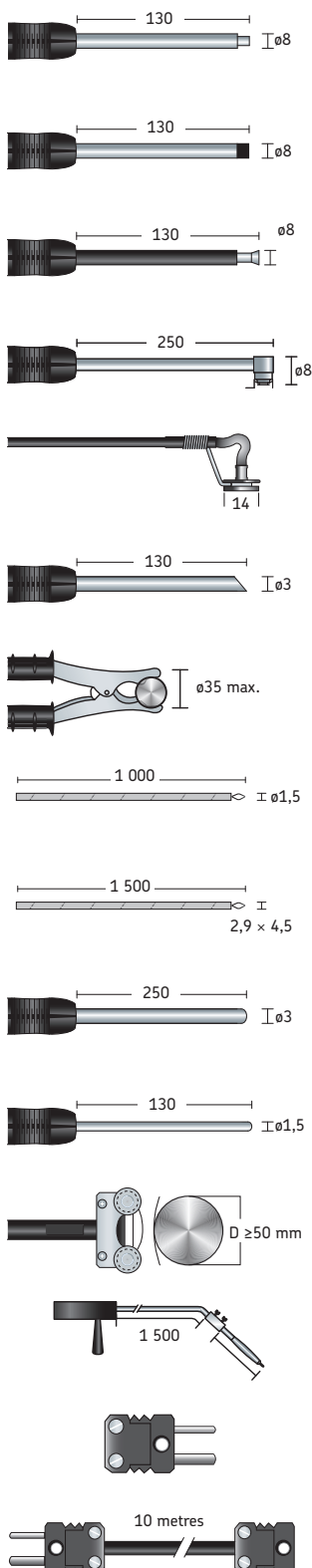

Designation	Description	Max. temp	Response time
TMDT 2-30	Standard surface probe For hard surfaces such as bearings, bearing housings, engine blocks, oven shields, etc.	900 °C (1 650 °F)	2,3 s
TMDT 2-43	Heavy duty surface probe Same as TMDT 2-30, but with a silicone encapsulated tip for heavy duty applications.	300 °C (570 °F)	3,0 s
TMDT 2-32	Insulated surface probe For hard surfaces where electrical wiring might cause short circuiting, e.g. electric motors, transformers, etc.	200 °C (390 °F)	2,3 s
TMDT 2-33	Right angle surface probe For hard surfaces in heavy-duty applications, e.g. machine components, engines, etc.	450 °C (840 °F)	8,0 s
TMDT 2-31	Magnetic surface probe For hard, magnetic surfaces; the integral heat sink design and low mass minimise thermal inertia and provide an accurate temperature measurement.	240 °C (460 °F)	7,0 s
TMDT 2-35	Probe with sharp tip Can be easily inserted into semi-solid materials like food-stuffs, meat, plastic, asphalt, deep-frozen products, etc.	600 °C (1 110 °F)	12,0 s
TMDT 2-36	Pipe clamp probe For temperature measuring on pipes, cables, etc. Diameter up to ø 35 mm (1.4 in.).	200 °C (390 °F)	8,0 s
TMDT 2-38	Wire probe Thin, lightweight, very fast response, fibreglass insulated.	300 °C (570 °F)	5,0 s
TMDT 2-39	High temperature wire probe Thin, light weight, very fast response, ceramic insulation.	1 350 °C (2 460 °F)	6,0 s
TMDT 2-34	Gas and liquid probe Flexible shank made of stainless steel for liquids, oils, acids, etc. and for use with high temperatures, e.g. open fire (not for molten metals).	1 100 °C (2 010 °F)	12,0 s
TMDT 2-34/1.5	Gas and liquid probe Same as TMDT 2-34 but with thin shank and faster response time. Very flexible, especially suitable for measuring temperature of gases.	900 °C (1 650 °F)	6,0 s
TMDT 2-40	Rotating probe For moving or rotating smooth surfaces. Four roller bearings provide suitable contact with the surfaces. Max. velocity 500 m/min.	200 °C (390 °F)	0,6 s
TMDT 2-41	Non-ferrous foundry probe Holder including dip-element for molten, non-ferrous metals. Highly resistant to corrosion and oxidation at high temperatures.	1 260 °C (2 300 °F)	30,0 s
TMDT 2-42	Ambient temperature probe For measurement of ambient temperature.		
TMDT 2-37	Extension cable For use with all K-type probes. Special lengths are available on request.		

All probes can be used with the SKF digital thermometers TKTL 20, TKTL 30 and TKTL 40 without recalibration.

Thermal imaging

Detect hot spots before they cause you trouble

Using an SKF Thermal camera is a proactive way to help you detect problems before they occur, increasing uptime and improving safety. They allow you to be able to visualise potential problems, invisible to the naked eye, by presenting a picture of the heat distribution of an asset. The thermal image, presented on a large LCD screen, shows you where the temperature is either too hot or too cold allowing you to pinpoint potential problems fast.



SKF Thermal Cameras allow you to:

- Detect problems before they occur
- Inspect your running equipment under full load, minimising production interference
- Safely inspect difficult to access live electrical equipment
- Inspect your plant under varying running conditions, allowing you to determine the potential causes of intermittent faults
- Reduce production losses due to unplanned downtime
- Reduce the time necessary for planned shutdowns
- Reduce your maintenance and repair costs
- Increase your equipment's lifetime and mean time between failures (MTBF)
- Increase your plant availability and reliability
- Realise a high return on your investment when used as a part of a well-run proactive maintenance programme

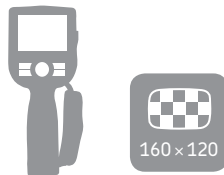

TKTI 21

- Easy hotspot detection and pinpointing at moderate distances
- Alarm function alerts you to troublesome hot spots
- Advanced display options available for experienced thermographers

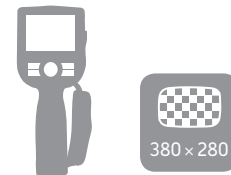

TKTI 31

- High resolution thermal imaging capability (40% more pixels than a 320 x 240 thermal camera)
- Wide temperature range from -20 to $+600$ °C (-4 to $+1112$ °F)
- Suitable for many thermal imaging applications at far distances

Analysis and reporting software suite

- Unique SKF software designed by and for real users
- Comprehensive analysis and reporting options are simple to use
- Easily produce professional results

Image



Analysis

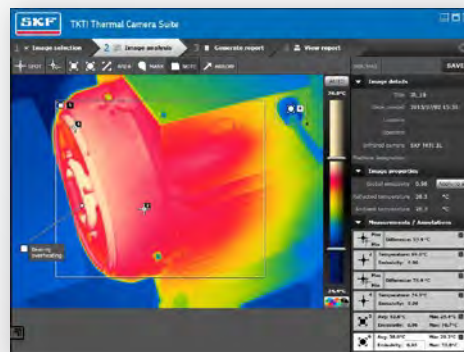

Report

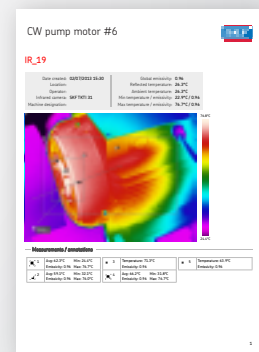

Rugged and ready

- Designed for use in tough work environments
- Wide operating temperature from -15 to $+50$ °C (5 to 122 °F)
- Supplied with two user rechargeable batteries which allow for almost constant use

Water splash

IP54

Dust protected



Easy to use

- Tactile button feedback allows use with gloves
- Simple, but comprehensive, menu structure
- Camera, with good weight balance, reduces user fatigue
- Live thermal pictures can be displayed on standard TV monitor (PAL/NTSC)

Visual and thermal



Overheating conveyor bearing

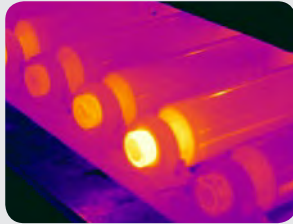

Distribution line faults

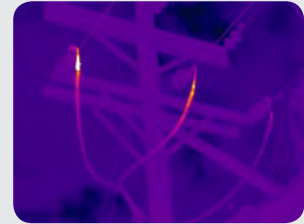

Fused disconnect

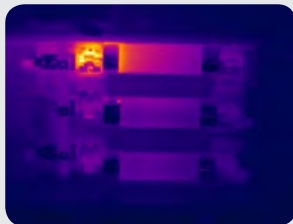

Steam traps

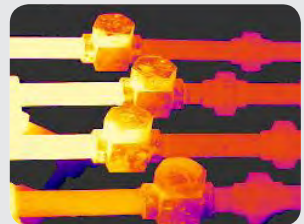

	TKTI 21	TKTI 31
Mechanical		
Bearings and housings	✓	✓
Belt and chain drives	✓	✓
Conveyor belt bearings	✓	✓
Coupling alignment	✓	✓
Heat exchangers	✓	✓
HVAC	✓	✓
Loose bolts		✓
Pipe insulation	✓	✓
Pumps	✓	✓
Refractory insulation		✓
Steam traps	✓	✓
Tank levels		✓
Valves	✓	✓
Electrical		
Electric motors, inc junction boxes	✓	✓
Electrical cabinet inspections	✓	✓
Electrical connection problems, incl. unbalanced loads, fuses and overloads	✓	✓
Power line connections		✓
Power lines		✓
Powerline capacitors		✓
Transformer bushings		✓
Transformer cooling and electrical	✓	✓
Buildings		
Buildings - indoors - insulation, moisture	✓	✓
Buildings - outdoors - moisture, heat, insulation, energy audits, roofs	✓	✓

Technical data

Designation	TKTI 21	TKTI 31
Performance		
Thermal detector (FPA)	160 × 120 uncooled FPA microbolometer	380 × 280 uncooled FPA microbolometer
Display	3.5 in. colour LCD with LED backlight, 11 colour palettes, thermal or visual image	3.5 in. colour LCD with LED backlight, 11 colour palettes, thermal or visual image
Thermal sensitivity	NETD ≤100 mK (0.10 °C) at 23 °C (73 °F) ambient and 30 °C (86 °F) scene temperature	NETD ≤60 mK (0.06 °C) at 23 °C (73 °F) ambient and 30 °C (86 °F) scene temperature
Field of view (FOV)	25 × 19°	25 × 19°
Spectral range	8–14 microns	8–14 microns
Theoretical spatial resolution IFOV	2.77 mrad	1.15 mrad
Measureable spatial resolution IFOV	8.31 mrad	3.46 mrad
Accuracy	The greater of ±2 °C or ±2% of reading in °C	The greater of ±2 °C or ±2% of reading in °C
Focus	Manual, easy turn ring, minimum distance 10 cm (3.9 in.)	Manual, easy turn ring, minimum distance 10 cm (3.9 in.)
Visual camera	1.3 Megapixel digital camera	1.3 Megapixel digital camera
Laser pointer	Built-in class 2 laser	Built-in class 2 laser
Frame rate and image frequency	9 Hz	9 Hz
Measurement		
Standard mode	–20 to +350 °C (–4 to +662 °F)	–20 to +180 °C (–4 to +356 °F)
High temperature mode	N/A	100 to 600 °C (212 to 1 112 °F)
Measurement modes	Up to 4 movable spots. Up to 3 movable areas and 2 movable lines (maximum, minimum and average temperatures). Automatic temperature difference. Hot and cold spots. Visual and audible alarms. Isotherms.	
Emissivity correction	User selectable 0.1 to 1.0 in steps of 0.01 with reflected and ambient temperature compensation. Emissivity can be individually adjusted on each cursor. Emissivity table of common surfaces built-in.	
Image Storage		
Medium	2 GB Micro SD card	2 GB Micro SD card
Number	Up to 10 000 images on Micro SD card supplied	Up to 10 000 images on Micro SD card supplied
Voice annotation	Input via built-in microphone for up to 60 seconds clip per image	Input via built-in microphone for up to 60 seconds clip per image
Software	Included SKF TKTi Thermal Camera suite. Comprehensive image analysis and report generation software compatible with TKTi 21 and TKTi 31. Free updates available on SKF.com	
Computer requirements	PC with Windows XP, Vista, Windows 7 or above	PC with Windows XP, Vista, Windows 7 or above
Connections		
PC connection	Mini USB connector for image export to PC software (Cable provided)	Mini USB connector for image export to PC software (Cable provided)
External DC input	12 V DC Input connector (DC Charger not provided)	12 V DC Input connector (DC Charger not provided)
Video output	1 × Mini-jack output for live image viewing (mini-jack to video cable provided)	1 × Mini-jack output for live image viewing (mini-jack to video cable provided)
Mounting	Handheld and tripod mounting 0.25 in. BSW.	Handheld and tripod mounting 0.25 in. BSW.
Battery and Power		
Battery	2 × 14,8 W, 7,4 V standard camcorder Li-ion batteries. Rechargeable and field replaceable	2 × 14,8 W, 7,4 V standard camcorder Li-ion batteries. Rechargeable and field replaceable
Operation time	Up to 4 hours continuous operation with 80% brightness	Up to 4 hours continuous operation with 80% brightness
Power adapter	External 100–240 V, 50–60 Hz AC battery compact charger with Europe cable, USA, UK and Australian plugs	External 100–240 V, 50–60 Hz AC battery compact charger with Europe cable, USA, UK and Australian plugs
Charging time	2 hours and 45 minutes	2 hours and 45 minutes
Complete system		
Contents	Thermal camera TKTi 21 with 2 × batteries; AC Battery Charger; Micro SD card (2GB); Mini USB to USB connection cable; Mini-jack to video connection cable; Micro SD card to USB adapter; CD containing instructions for use and PC software; Certificate of calibration and conformance; Quick start guide (English); Carrying case.	Thermal camera TKTi 31 with 2 × batteries; AC Battery Charger; Micro SD card (2GB); Mini USB to USB connection cable; Mini-jack to video connection cable; Micro SD card to USB adapter; CD containing instructions for use and PC software; Certificate of calibration and conformance; Quick start guide (English); Carrying case.
Warranty	2 years standard warranty	2 years standard warranty
Carrying case dimensions	105 × 230 × 345 mm (4.13 × 9.06 × 9.65 in.)	105 × 230 × 345 mm (4.13 × 9.06 × 9.65 in.)
Weight (incl. battery)	1,1 kg (2.42 lb)	1,1 kg (2.42 lb)

Pinpoint accuracy combined with measurement versatility

SKF Tachometer Series

The SKF Tachometers are fast and accurate instruments utilizing laser or contact to measure rotational and linear speeds. Equipped with a laser and a range of contact adapters, they are versatile instruments that suit a wide range of applications. Having a compact design, they can be operated with just one hand and are supplied in a sturdy carrying case.



TKRT 10

- Wide speed measurement range: up to 99 999 r/min for laser measurement and 20 000 r/min using contact adapters
- Measurement modes include; rotational speed, total revolutions, frequency, surface speed and length in both metric and imperial units
- Laser can be used for safe and quick, non-contact rotational speed measurements at distances up to 0,5 m (20 in.)
- Large back-lit LCD display enables easy reading in almost all light conditions
- Angular range of $\pm 45^\circ$ to target helps facilitate easy measuring
- Up to 10 readings can be stored for later reference

TKRT 20

- The user can select the following to measure:
 - rpm, rps, m, ft or yds per minute or second,
 - length or revolution counting, or
 - time interval
- Wide speed range and the various measurement modes make the SKF TKRT 20 suitable for measuring speed in many applications
- Large angular range of $\pm 80^\circ$ to target facilitates easy measuring in areas where straight-line access is difficult
- The laser optical system allows easy and quick measurements at a safe distance from rotating machinery
- The large inverting LCD display facilitates easy reading, even when pointing the unit down into the machinery
- The SKF TKRT 20 can also be equipped with a remote laser sensor, which is optionally available



The laser optical system allows easy and quick measurements at a safe distance from rotating machinery.

Technical data

Designation	TKRT 10	TKRT 20
Display	5 digit LCD backlit display	Inverting vertical 5 digit LCD
Memory	10 readings memories	Last reading held for 1 minute
Measurement		
Optical modes	r/min, hertz	r/min and r/s (also count and time interval)
Contact modes	r/min, metres, inches, yards, feet, per min, hertz	r/min and r/s, metres, yards, feet, per min and per sec
Count modes	total revs, metres, feet, yards	total revs, metres, feet, yards
Sampling time	0,5 seconds (over 120 r/min)	0,8 seconds or time between pulses 0,1 seconds auto-selection in max or min capture mode
Linear speed	0,2 to 1 500 metres/min (4 500 ft/min)	0,3 to 1 500 metres/min (4 500 ft/min) or equivalent in seconds
Optical measurement		
Rotational speed range	3 to 99 999 r/min	3 to 99 999 r/min
Accuracy	±0,05% of reading ±1 digit	±0,01% of reading ±1 digit
Measuring distance	50 to 500 mm (1.9 to 19.7 in.)	50 to 2 000 mm (1.9 to 78.7 in.)
Angle of operation	±45°	±80°
Laser sensor	1 × built-in class 2 laser	1 × built-in class 2 laser
Remote laser sensor	N/A	Optional TMRT 1-56
Contact measurement		
Rotational speed range	2 to 20 000 r/min	Max. 50 000 r/min for 10 sec
Accuracy	±1% of reading ±1 digit	±1% of reading ±1 digit
Contact adaptors	Included with conical tip, conical recess and wheel	Included with r/min cone and removable metric wheel assembly
Battery	1 × 9 V alkaline type IEC 6F22	4 × AAA alkaline type IEC LR03
Operation time	12 hours continuous use	24 hours continuous use
Product dimensions	160 × 60 × 42 mm (6.3 × 2.4 × 1.7 in.)	213 × 40 × 39 mm (8.3 × 1.5 × 1.5 in.)
Product weight	160 g (0.35 lb)	170 g (0.37 lb)
Carrying case dimensions	260 × 85 × 180 mm (10.3 × 3.4 × 7.0 in.)	260 × 85 × 180 mm (10.3 × 3.4 × 7.0 in.)
Operating temperature	0 to 50 °C (32 to 122 °F)	0 to 40 °C (32 to 104 °F)
Storage temperature	-10 to +50 °C (14 to 122 °F)	-10 to +50 °C (14 to 122 °F)
Relative humidity	10 to 90% RH non-condensing	10 to 90% RH non-condensing
IP rating	IP 40	IP 40

Easy, cost effective inspection in a flash

SKF Stroboscopes TKRS series

The SKF Stroboscopes, TKRS 10 and TKRS 20 are portable, compact, easy-to-use stroboscopes that enable the motion of rotating or reciprocating machinery to appear frozen. They allow such applications as fan blades, couplings, gear wheels, machine tool spindles and belt drives to be inspected while running. TKRS stroboscopes are useful for ODR programmes and are an essential instrument for maintenance technicians.



TKRS 10

- Flash rates of up to 12 500 flashes per minute cover a wide range of applications
- Easy to read LCD display
- Xenon flashtube source lasts for at least 100 million flashes
- Supplied with an extra flashtube to minimise unit downtime
- Rechargeable power pack allows up to 2,5 hours of use between charging

The TKRS series have the following features:

- Ergonomic controls enable the flash rate to be set in a matter of seconds
- Phase shift mode enables the viewing of the object of interest to be rotated to the correct position for viewing; especially useful for gear wheels and fan blade inspection
- For ease of use for extended periods, they are equipped with a tripod mounting thread
- Supplied in a sturdy carrying case with universal charger



TKRS 20

- Low energy consuming LED light source lets the rechargeable power pack to typically operate for at least twelve hours
- Bright and powerful flash gives a good target illumination at a distance, with a focused viewing area, and is ideal for outdoor use
- Flash rates of up to 300 000 flashes per minute cover most high speed applications. For routine inspections, the powerful lamp mode is useful
- A remote optical sensor is included enabling the flash rate to be easily triggered, and also enables the stroboscope to be used as a tachometer
- Easy to read LCD display shows user settings, and enables the ten user programmable flash rate memories to be quickly recalled
- Using the optional cable TKRS C1, the TKRS 20 can be connected to a SKF Microlog



Technical data



Designation	TKRS 10	TKRS 20
Flash rate range	40 to 12 500 flashes per minute (f/min.)	30 to 300 000 flashes per minute (f/min.)
Optical sensor flash rate range	Not applicable	30 to 100 000 f/min.
Flash rate accuracy	±0,5 f/min. or ±0,01% of reading, whichever is greater	±1 f/min. or ±0,01% of reading, whichever is greater
Flash setting and display resolution	100 to 9 999 f/min.; 0,1 f/min., 10 000 to 12 500 f/min.; 1 f/min.	30 to 9 999 f/min.; 0,1 f/min., 10 000 to 300 000 f/min.; 1 f/min.
Tachometer range	40 to 59 000 r/min.	30 to 300 000 r/min.
Tachometer accuracy	±0,5 r/min. or ±0,01% of reading, whichever is greater	±0,5 r/min. or ±0,01% of reading, whichever is greater
Flash source	Xenon tube: 10 W	LED
Flash duration	9–15 µs	0,1°–5°
Light power	154 mJ per flash	1 600 lux at 6 000 f/min. at 0,2 m (8 in.)
Power pack type	NiMH, rechargeable and removable	NiMH, rechargeable and removable
Power pack charge time	2–4 hours	2–4 hours
Run time per charge	2,5 hours at 1 600 f/min., 1,25 hours at 3 200 f/min.	12 hours typical usage 6 hours with optical sensor
Battery charger AC input	100–240 V AC, 50/60 Hz	100–240 V AC, 50/60 Hz
Display	8 character by 2 line LCD, alphanumeric	8 character by 2 line LCD, alphanumeric
Display update	continuous	continuous
Controls	Power, ×2, ×1/2, phase shift, external trigger	Power, ×2, ×1/2, phase shift, external trigger, pulse length and memory
External trigger input	0–5 V TTL type via stereo phono jack	0–5 V TTL type via stereo phono jack
EXTL. trigger to flash delay	5 µs maximum	5 µs maximum
Clock output 0–5 V TTL	Type signal via stereo phono jack	Type signal via stereo phono jack
Weight	650 g (1 lb, 7 oz.)	600 g (1 lb, 5 oz.)
Carrying case dimensions	360 × 110 × 260 mm (14.2 × 4.3 × 10.2 in.)	360 × 110 × 260 mm (14.2 × 4.3 × 10.2 in.)
Operating temperature	10 to 40 °C (50 to 104 °F)	10 to 40 °C (50 to 104 °F)
Storage temperature	–20 to +45 °C (–4 to +113 °F)	–20 to +45 °C (–4 to +113 °F)



Fast and easy inspection with video function

SKF Endoscopes TKES 10 series

SKF Endoscopes are first line inspection tools that can be used for internal inspection of machinery. They help minimise the need to disassemble machinery for inspection, saving time and money. The compact display unit, with 3.5" backlit screen, allows images and video to be saved and recalled, or to be downloaded and shared with others. Three different models cater to most needs and are equipped with powerful variable LED lighting allowing inspections in dark locations.

- High resolution miniature camera, with up to 2x digital zoom, gives a clear and sharp full screen image
- Available with a 1 metre (3.3 ft) insertion tube in three different variants; flexible, semi-rigid or with an articulating tip
- Small tip diameter of 5,8 mm (0.23 in.), with a wide field of view, allows easy access to most applications
- Supplied with a side view adapter allowing inspection of applications such as pipe walls
- Powerful magnets, and a tripod mount on the back of the display unit, allow the display unit to be used "hands free"
- Up to 50 000 photos or 120 minutes of video can be stored on the SD memory card supplied
- Longer flexible and semi-rigid insertion tubes are available as accessories
- Supplied in a sturdy carrying case complete with all necessary cables, universal mains charger and cleaning kit





Photos and videos can be transferred to PC using the USB cable provided.

Technical data



Designation	TKES 10F	TKES 10S	TKES 10A
Insertion Tube & Light Source	Flexible tube	Semi-rigid tube	Tube with an articulating tip
Image Sensor	CMOS Image Sensor	CMOS Image Sensor	CMOS Image Sensor
Resolution (H × V)			
– Still Image (static)	640 × 480 pixels	640 × 480 pixels	320 × 240 pixels
– Video (dynamic)	320 × 240 pixels	320 × 240 pixels	320 × 240 pixels
Size Tip (Insertion Tube) Diameter	5,8 mm (0.23 in.)	5,8 mm (0.23 in.)	5,8 mm (0.23 in.)
Tube length	1 m (39.4 in.)	1 m (39.4 in.)	1 m (39.4 in.)
Field of View	67°	67°	55°
Depth of Field	1,5–6 cm (0.6–2.4 in.)	1,5–6 cm (0.6–2.4 in.)	2–6 cm (0.8–2.4 in.)
Light Source	4 White adjustable LED (0–275 Lux/4 cm)	4 White adjustable LED (0–275 Lux/4 cm)	4 White adjustable LED (0–275 Lux/4 cm)
Probe Working Temperature	–20 to +60 °C (–4 to +140 °F)	–20 to +60 °C (–4 to +140 °F)	–20 to +60 °C (–4 to +140 °F)
Ingress Protection Level	IP 67	IP 67	IP 67



Display Unit

Power	5 V DC
Display	3.5" TFT LCD Monitor 320 × 240 pixels
Interface	Mini USB 1.1 / AV out / AV in/
Battery (not user serviceable)	Rechargeable Li-Polymer Battery (3.7V). Typically 4 hours operation after a 2 hour charge.
Video Out Format	NTSC & PAL
Recording medium	SD card 2 GB supplied – storage capacity ±50 000 photos, or 120 minutes video. (SD/SDHC Cards up to 32 GB can be used)
Output resolution (H × V)	
– Still Image (JPEG)	640 × 480 pixels
– Video recording format (ASF)	320 × 240 pixels
Temperature range	
– Working & Storage	–20 to +60 °C (–4 to +140 °F)
– Battery charging temperature range	0 to 40 °C (32 to 104 °F)
Functions	Snapshot, Video recording, Picture & video review on LCD screen, TV Out, transfer of picture & video from SD card to PC

Easily pinpoints bearing and machine noise

SKF Electronic Stethoscope TMST 3

The SKF TMST 3 is a high quality instrument enabling the determination of troublesome machine parts by the detection of machine noises. TMST 3 includes a headset, two different length probes (70 and 220 mm) and a pre-recorded audio CD demonstrating the most common encountered troublesome machine noises, all supplied complete in a sturdy carrying case.

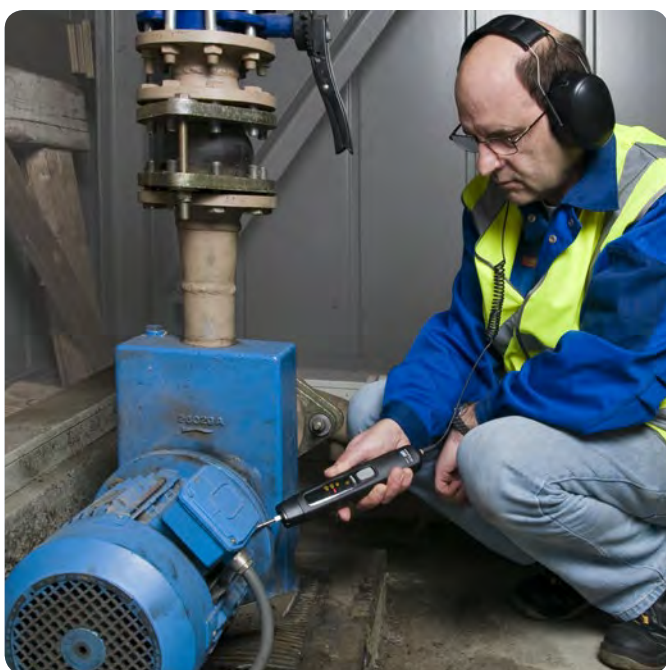

- User friendly and easy to operate, no special training required
- Lightweight ergonomic design makes it easy to operate with one hand
- Excellent sound quality helps to reliably identify the possible cause of the noise
- Excellent quality headset for optimum sound quality even in very high-noise environments
- Pre-recorded demonstration CD and output for analogue recording help facilitate analysis and comparison
- Supplied with two probes, 70 and 220 mm (2.8 and 8.7 in.) long
- Adjustable digital volume control up to 32 levels to reach desired volume



Technical data

Designation	TMST 3
Frequency range	30 Hz–15 kHz
Operating temperature	–10 to +45 °C (14 to 113 °F)
Output volume	Adjustable in 32 levels
Led indicator	Power on Sound volume Battery low
Maximum recorder output	250 mV
Headset	48 ohm (with ear defender)
Auto switch off	Yes, after 2 min.

Battery	4 × AAA Alkaline type IEC LR03 (included)
Battery lifetime	30 hours (continuous use)
Dimensions handset	220 × 40 × 40 mm (8.6 × 1.6 × 1.6 in.)
Probe length	70 and 220 mm (2.8 and 8.7 in.)
Carrying case dimensions	360 × 110 × 260 mm (14.2 × 4.3 × 10.2 in.)
Weight	
Total weight	1 600 g (3.5 lb)
Instrument	162 g (0.35 lb)
Headset	250 g (0.55 lb)

Easy noise level measurement

SKF Sound Pressure Meter TMSP 1

The SKF TMSP 1 is a high quality, handheld instrument for measuring the sound level in decibels. The environmental noise is picked up by the microphone and then processed by the handset. The noise can be monitored both quantitatively and qualitatively. The SKF Sound Pressure Meter is supplied in a carrying case complete with windshield, calibration screwdriver, jack for external outputs and an alkaline battery.

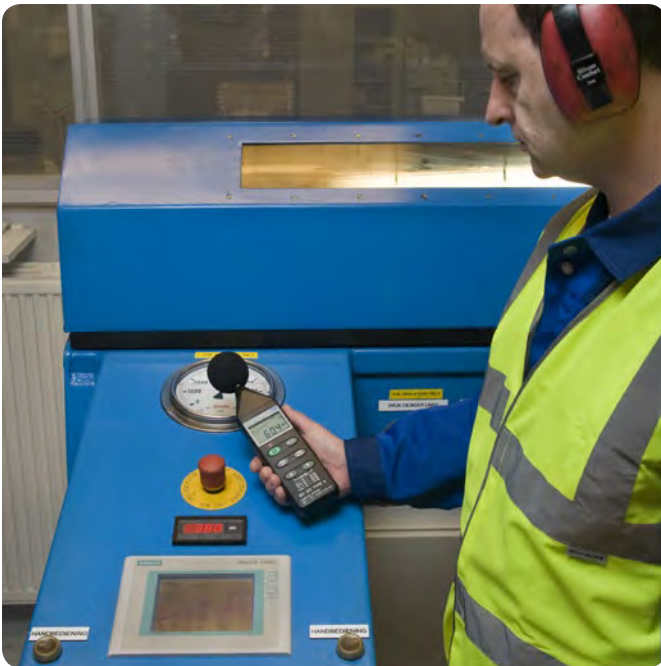

- User friendly and easy to operate, no special training required
- dBA and dBC scale weightings for both general sound level and low frequency noise measurements
- Fast and slow time weighting enables either normal measurements or the average level of fluctuating noise
- Four different measurement scales to suit almost all situations
- User selectable backlight for use in environments with poor lighting
- Four digit LCD panel with both digital and bar graph display
- Max and min function for peak measurements and alarm function to indicate when the noise level is too low or too high
- Tripod mounting thread for use when the instrument must remain in the same position for a prolonged period



Technical data

Designation	TMSP 1
Frequency range	31,5 Hz to 8 KHz
Measuring level range	30 to 130 dB
Display	LCD
Digital display	4 digits, Resolution: 0,1 dB, Display update: 0,5 s
Analogue display	50 segments bar-graph Resolution: 1 dB Display update: 100 ms
Time weighting	Fast (125 ms), Slow (1 s)
Level ranges	Lo = 30-80 dB, Med = 50-100 dB, Hi = 80-130 dB, Auto = 30-130 dB
Accuracy	±1,5 dB (ref 94 dB at 1 KHz)
Conformity	Fulfills IEC651 type 2, ANSI S1.4 type 2 for sound level meters

Dynamic range	50 dB
Power supply	9 V Alkaline type IEC 6LR61
Power life	50 hours (with alkaline battery)
Operation temperature	0 to 40 °C (32 to 104 °F)
Operation humidity	10 to 90% relative humidity
Operation altitude	Up to 2 000 m (6 560 ft) above sea level
Dimensions	275 × 64 × 30 mm (10.8 × 2.5 × 1.2 in.)
Carrying case dimensions	530 × 85 × 180 mm (20.9 × 3.4 × 7.0 in.)
Weight	285 g (0.76 lb) including battery
Total weight (incl.case)	1 100 g (2.4 lb)

Quick and easy detection of air leaks

SKF Ultrasonic Leak Detector TMSU 1

The SKF TMSU 1 is a high quality, user-friendly instrument enabling the detection of air leaks by means of ultrasound. Leaks are caused by fluid flowing from a high pressure environment to a low pressure environment, creating turbulence. The turbulence generates high frequency sounds (so called ultrasound) that can be detected by SKF TMSU 1. The operator simply guides the instrument to the loudest point, which helps locate the leak location.



SKF TMSU 1 also includes a headset, rubber nozzle and batteries, supplied complete in a sturdy carrying case.

- Lightweight compact design makes it easy to operate with one hand
- User friendly, no special training required
- By identifying air leaks and fixing them, energy consumption is significantly reduced
- The flexible tube allows access to confined spaces
- The headset provides high sound quality even in very high-noise environments, and also helps to protect the ears
- Wide operating temperature



Technical data

Designation	TMSU 1
Amplification	7 levels: 20, 30, 40, 50, 60, 70 and 80 dB
Ultrasound sensor	19 mm (0.75 in.) diameter central frequency of 40 kHz
Detected frequencies	38,4 kHz, ± 2 kHz (-3 dB)
Power	Two alkaline AA batteries, 1,5 V. Rechargeable batteries can also be used
Battery life	Typically 20 hours
Dimensions	Body: 170 × 42 × 31 mm (6.70 × 1.65 × 1.22 in.) Flexible tube length: 400 mm (15.75 in.)
Weight	0,4 kg (0.9 lb) incl. batteries
Carrying case dimensions	530 × 110 × 360 mm (20.9 × 4.3 × 14.2 in.)
Operating temperature range	-10 to +50 °C (14 to 122 °F)

Note: The SKF TMSU 1 is not ATEX approved

Unique, reliable and safe method to detect electrical discharges in electric motor bearings

SKF Electrical Discharge Detector Pen TKED 1

The SKF TKED 1 (EDD Pen) is a simple to use hand-held instrument for detecting electrical discharges in electric motor bearings. Electrical discharges are a result of motor shaft voltages discharging to earth through the bearing, causing electrical erosion, lubricant degradation and ultimately bearing failure.



Electric motors are more vulnerable to suffer electrical erosion in bearings when controlled by a Variable Frequency Drive. When incorporated into a predictive maintenance programme, the EDD Pen can help detect bearings more susceptible to failure, and to a significant degree, prevent unplanned machine downtime.

- Unique remote solution allows operation at a distance from the motors. This helps protect the user from touching machinery in motion
- SKF developed technology*
- No special training required
- Capable of detecting electrical discharges on a time base of 10 seconds, 30 seconds or infinite
- LED backlit screen, allows use in dark environments
- IP 55 can be used in most industrial environments
- Supplied standard with batteries, a spare antenna and language-free instructions for use in a carrying case

* Patent applied for

Technical data

Designation	TKED 1
Power supply	4,5 V 3 × AAA Alkaline type IEC LR03
Time control:	
– pre-sets	10 or 30 seconds
– default	indefinite
Operational and storage temperature	0 to 50 °C (32 to 122 °F) –20 to +70 °C (–4 to +158 °F)
Ingress protection level	IP 55
Display	LCD counter range: 0 to 99 999 discharges. User selectable backlight and low battery warning
Carrying case dimensions	260 × 85 × 180 mm (10.3 × 3.4 × 7.0 in.)
Total case and contents weight	0,4 kg (0.88 lb)



Lubricant degradation caused by electrical discharge currents



Fluting marks characteristic of electrical erosion in bearings

Reliability meets affordability

SKF Machine Condition Indicator CMSS 200

The SKF Machine Condition Indicator is an economical vibration sensor and temperature indicator for monitoring non-critical machines. It is ideal for machinery with constant operating conditions, which has not been previously monitored. The device can be compared to the “check engine” light in a car.



- Provides a simple, low cost solution to determine the basic machine health on assets not necessarily being monitored
- Frees up time to concentrate on root cause analysis or maintenance instead of problem detection
- Non-critical machine routes could be more widely spaced, e.g., every other month instead of monthly, with the SKF Machine Condition Indicator installed and replaced by a simple, quick check of the LEDs
- Velocity measurements for general machine health
- Enveloped acceleration measurements for early detection of bearing failure
- Temperature measurements to indicate uncharacteristic heat
- Two modes of operation to address many different machine types
- Transient protection and retry algorithm to avoid false alarming



The top of the unit features three LEDs to indicate the machine and bearing condition. In addition, it features a barcode with serial number for machine identification purposes and easy incorporation into an Operator Driven Reliability (ODR) program, maintenance routes or scheduled check-ups. The stainless steel base on the bottom of the unit has 1/4-28 tapped threads for stud mounting.



A magnetic read-key is included to program the SKF Machine Condition Indicator. It is used to activate the SKF Machine Condition Indicator, change operating modes, set vibration baselines, acknowledge alarms, and reset the SKF Machine Condition Indicator.

Ordering details

Designations	CMSS 200-02-SL	CMSS 200-10-SL	CMSS 200-50-SL
Includes	2 × battery operated units 2 × CMAC 225 read-keys (magnets) 2 × CMAC 230 threaded mounting studs (1/4-28 to 1/4-28) 2 × CMAC 231 adapter mounting studs (1/4-28 to M8) 2 × CMAC 200-REF reference cards 1 × installation instruction card 1 × product reference CD	10 × battery operated units 4 × CMAC 225 read-keys (magnets) 4 × CMAC 200-REF reference cards 2 × installation instruction card 1 × product reference CD	50 × battery operated units 10 × CMAC 225 read-keys (magnets) 10 × CMAC 200-REF reference cards 5 × installation instruction card 1 × product reference CD

Note: The mounting studs are not included in the 10-pack CMSS 200-10-SL or 50-pack CMSS 200-50-SL and must be ordered separately.

Accessories

Designations	Description
CMAC 225-10	Magnetic read-keys, 10-pack
CMAC 230-10	Threaded mounting studs (1/4-28 to 1/4-28), stainless steel, 10-pack
CMAC 230-50	Threaded mounting studs (1/4-28 to 1/4-28), stainless steel, 50-pack
CMAC 231-10	Adapter mounting studs (1/4-28 to M8), stainless steel, 10-pack
CMAC 231-50	Adapter mounting studs (1/4-28 to M8), stainless steel, 50-pack
CMAC 9600-01	Toolkit for spot face, 1/4-28 mounting
CMAC 9600-02	Toolkit for spot face, M8 × 1,25 mounting
CMCP 210	Acrylic adhesive bypacs*
CMAC 240-10	Mounting pad, 25,4 mm (1 in.) diameter × 6,4 mm (0.250 in.) thick, stainless steel, 10-pack
CMAC 240-50	Mounting pad, 25,4 mm (1 in.) diameter × 6,4 mm (0.250 in.) thick, stainless steel, 50-pack
CMAC 241-10	Mounting pad, 25,4 mm (1 in.) diameter × 9,5 mm (0.375 in.) thick, stainless steel, 10-pack
CMAC 241-50	Mounting pad, 25,4 mm (1 in.) diameter × 9,5 mm (0.375 in.) thick, stainless steel, 50-pack

* Shipping restrictions apply

Technical data

Designation	CMSS 200
Velocity measurement	10 Hz to 1 kHz / minimum speed 900 r/min
Bearing measurement	Enveloped acceleration to enable an early Stage 3 bearing defect to be detected for speeds between 900 and 3 600 r/min
Machine surface temperature measurement range	-20 to +105 °C (-5 to +220 °F)
Rating	IP 69K, for use in adverse industrial environments
Alarm system	Three LEDs (green, red and orange)
Mounting	Stud mounted or epoxy mount (stud not included in 10 or 50 pack)
Internal operating temperature range	-20 to +85 °C (-5 to +185 °F)
Wake up schedule	Eight times per day
Battery life	3 years (with one unacknowledged alarm)

Battery type	Lithium battery 3,6 V, single use, non-replaceable
Enclosure	White durable polymer cap PC/PET Blend, Bayer Makroblend UT 1018-1000 and a stainless steel base
Weight	120 g (4.2 oz.)

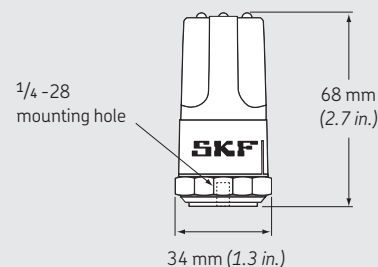

Machine monitoring, made simple

SKF Machine Condition Advisor CMAS 100-SL

Both novice users and experts can easily, quickly, and accurately check the condition of rotating equipment throughout their facility. Equipping your maintenance and operation personnel with this rugged, ergonomic and easy-to-use instrument can help to provide early warning of potential machine problems before a costly failure occurs.



Multiple measurements with a single device

The SKF Machine Condition Advisor provides an overall “velocity” vibration reading that measures vibration signals from the machine caused by rotational and structural problems such as unbalance, misalignment and looseness and automatically compares them to pre-programmed ISO guidelines. An “alert” or “danger” alarm displays when measurements exceed those guidelines. Simultaneously, an “enveloped acceleration” measurement in the higher frequencies is taken.

Elevated readings are caused by rolling element bearing or gear mesh problems and compared to established bearing vibration guidelines to verify conformity or indicate potential bearing damage. The SKF Machine Condition Advisor also measures temperature using an infrared sensor to indicate uncharacteristic heat.

This approach provides accurate and reliable data upon which to base maintenance decisions and promotes early detection, confirmation and accurate trending of bearing and machinery problems.



- Measuring velocity, enveloped acceleration, and temperature simultaneously saves time
- Assess vibration in industrial non-reciprocating machinery
- Lightweight, compact, and ergonomically designed, the SKF Machine Condition Advisor fits neatly at the belt line, in a pocket or a tool kit
- Exceptionally durable, the unit is rated IP 54 for use in industrial environments
- Quick and easy to set up and use, measurements are shown on a bright display viewable in low light to direct sunlight. Free on-line training is also available at SKF @ptitude Exchange
- Alert and danger prompts provide increased diagnostic confidence
- Efficient, economical, and environmentally friendly, the rechargeable SKF Machine Condition Advisor operates 10 hours on a single charge
- Flexible enough to work with standard constant current 100 mV/g accelerometers, an optional external sensor can be used for hard-to-reach locations and for more repeatable and accurate measurement results
- Features English, French, German, Portuguese, Spanish and Swedish for user convenience

For more information, please refer to our publication 10549 EN.

Technical data

Designation	CMAS 100-SL
Vibration pick-up	Internal: Integrated piezoelectric acceleration External: Accepts a standard 100 mV/g constant current accelerometer
Measurements	
Velocity	Range: 0,7 to 65,0 mm/s (RMS) 0.04 to 3.60 in./s (equivalent Peak) meets ISO 10816 Frequency: 10 to 1 000 Hz, meets ISO 2954
Enveloped Acceleration	Range: 0,2 to 50 gE Frequency: Band 3 (500 to 10 000 Hz)
Temperature	Range: -20 to +200 °C (-4 to +392 °F) Infrared temperature accuracy: ±2 °C (±3.6 °F) Distance: Short range, max. 10 cm (4 in.) from target
Operating temperature range	In use: -10 to +60 °C (14 to 140 °F) While charging: 0 to 40 °C (32 to 104 °F)
Storage temperature	Less than one month: -20 to +45 °C (-4 to +113 °F) More than one month but less than six months: -20 to +35 °C (-4 to +95 °F)

Humidity	95% relative humidity, non-condensing
Ingress Protection	IP 54
Approvals	CE (Certified Engineering)
Drop test	2 m (6.6 ft.)
Weight	125 g (4.4 oz.)
Dimensions	200 × 47 × 25 mm (7.9 × 1.85 × 1 in.)
Battery capacity	550 mAh
Battery life	10 hours before charging (approx. 1 000 measurements) With external sensor: Up to 55% less battery life
External sensor power	24 V DC at 3,5 mA
Charger specifications	Universal AC/DC wall plug-in Input: 90 to 264 VAC, 47 to 60 Hz Output: 5 V DC regulated 3 to 4 hours for a full charge



Easy detection of high frequency sounds

Inspector 400 Ultrasonic Probe CMIN 400-K

The Inspector 400 Ultrasonic Probe senses high frequency sounds produced by operating equipment, as well as leaks and electrical discharges. It electronically translates these signals by a heterodyning process, making them audible, so that a user can hear these sounds through a headset and see them as intensity increments on a meter.

- Detects pressure and vacuum leaks, including compressed air
- Checks steam traps and valves quickly and accurately
- Detects arcing, tracking and corona in electric apparatus
- Tests bearings, pumps, motors and compressors
- Frequency response: 20–100 kHz (centred at 38–42 kHz)
- Indicator: 10-segment LED bar graph (red)

For additional information, please refer to our publication 10549 EN.

Lubricants

SKF lubricants selection	120
SKF bearing grease selection chart	122
Bearing greases	
– SKF LGMT 2	126
– SKF LGMT 3	127
– SKF LGEP 2	128
– SKF LGWA 2	129
– SKF LGGB 2	130
– SKF LGBB 2	131
– SKF LGLT 2	132
– SKF LGWM 1	133
– SKF LGWM 2	134
– SKF LGEM 2	135
– SKF LGEV 2	136
– SKF LGHB 2	137
– SKF LGHP 2	138
– SKF LGET 2	139
Food grade lubricants	
– SKF LGFP 2	140
– SKF LGFS 00	141
– SKF LGFD 2	142
– SKF LGFC 1	143
– SKF LGFT 2	144
– SKF LFFH 46	145
– SKF LFFH 68	145
– SKF LFFG 220	146
– SKF LFFG 320	146
– SKF LFFM 80	147
– SKF LHFP 150	147
– SKF LFFT 220	147
– SKF LDTS 1	148
Special lubricants	
– SKF LESA 2	149
– SKF LEGE 2	149
– SKF LMCG 1	150
– SKF LGLS 0	150
– SKF LHMT 68	151
– SKF LHHT 265	151
Technical data	152

Storage tools

Oil storage station	156
SKF Grease Filler Pumps LAGF series	157
SKF Bearing Packer VKN 550	157

Transfer tools

Hose reels TLRC & TLRS series	158
-------------------------------	-----

Manual grease dispensing tools

SKF Grease Guns	159
SKF Grease Meter LAGM 1000E	160
SKF Grease Nozzles LAGS 8	161
SKF Grease Nipples LAGN 120	161
SKF Grease fitting caps and tags TLAC 50	162
SKF Disposable Grease Resistant Gloves TMBA G11D	162
SKF Grease Pumps LAGG series	163

Automatic grease dispensing tools

SKF LAGD series	166
SKF TLSD series	168
SKF TLMR series	170
Accessories	172
SKF LAGD 400 and LAGD 1000	174

Oil inspection & dispensing

Oil handling containers LAOS series	175
SKF Oil Levellers LAHD series	176

Lubrication analysis tools

SKF Grease Test Kit TKGT 1	178
SKF Oil Check Monitor TMEH 1	179

Lubrication software

LubeSelect for SKF greases	180
SKF Lubrication Planner	180
SKF DialSet	181

Lubrication

Lubricants	120
Storage tools	156
Transfer tools	158
Manual grease dispensing tools	159
Automatic grease dispensing tools	164
Oil inspection & dispensing	175
Lubrication analysis tools	178
Lubrication software	180

Lubricants

*Lubrication
management
tools*

*Automatic
lubricators*

*Manual
lubrication
tools*

*Lubrication
software*



Lubrication

Poor lubrication accounts for more than 36% of premature bearing failures

Include contamination, and this number rises to well above 50%. The importance of proper lubrication and cleanliness is self-evident in the determination of bearing life.

What the right lubrication programme can do for you



Increase

- Productivity
- Reliability
- Availability and durability
- Machine uptime
- Service intervals
- Safety
- Health
- Sustainability

Reduce

- Energy consumption due to friction
- Heat generation due to friction
- Wear due to friction
- Noise due to friction
- Downtime
- Operating expenses
- Product contamination
- Maintenance and repair costs
- Lubricant consumption
- Corrosion



From lubrication to lubrication management



A good lubrication programme can be defined by applying the 5R approach:

“The right lubricant, in the right amount, reaches the right point at the right time using the right method”

This simple and logical approach, however, requires a detailed action plan that must include aspects as varied as:

- Logistics and supply chain
- Lubricant selection
- Lubricant storage, transfer and dispensing
- Lubrication tasks planning and scheduling
- Lubricant application procedures
- Lubricant analysis and condition monitoring
- Lubricant disposal
- Training

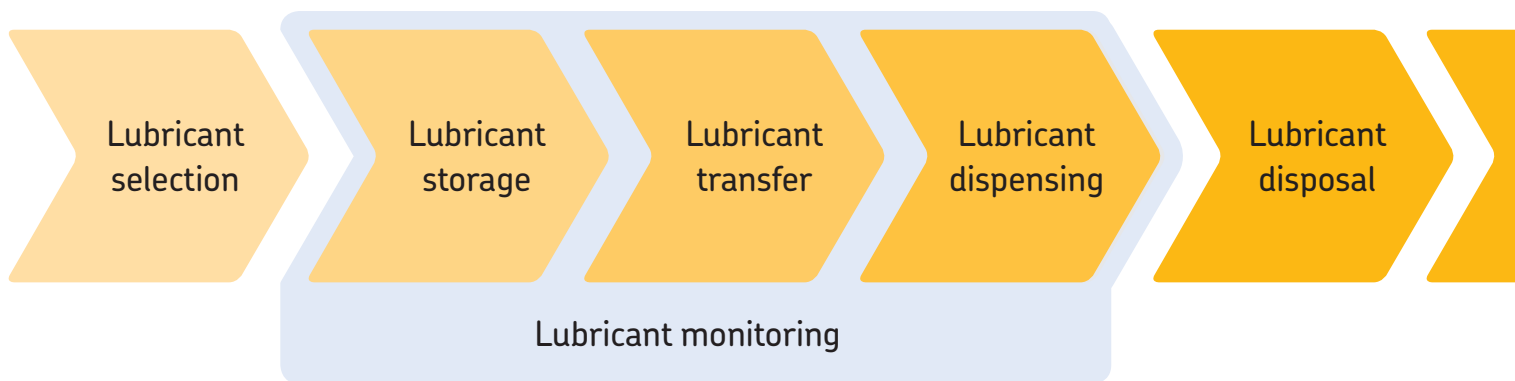

Selecting a suitable grease for a particular bearing is a crucial step if the bearing is to meet design expectations in its application. Use the SKF LubeSelect to select the right lubricant for your application.

During storage, maintenance and transfer steps, the lubricant can easily get contaminated due to lack of lubrication knowledge or simply lack of attention. To minimize the risks of lubricant contamination in storage and transfer, we recommend the use of the Oil storage station and Oil handling containers LAOS series. For the transfer of greases, we offer an extensive range of SKF Grease Pumps, SKF Grease Filler Pumps and SKF Bearing Packer.

For the correct lubricant dispensing, consider the range of SKF Grease Guns and SKF range of single and multi point lubricators. SKF DialSet helps you select the right lubricator settings for the application.

For the monitoring of the lubricant, SKF offers the following tools: SKF Oil Levellers, SKF Oil Check Monitor and SKF Grease Test Kit.

Lubrication management

Just as asset management takes maintenance to a higher level, a lubrication management approach allows lubrication to be seen from a wider point of view. This approach helps to effectively increase machine reliability at a lower overall cost.

SKF Lubrication Management process



- **SKF Client Needs Analysis:** Normally implies one day of assessment and provides an overview on the lubrication programme maturity
- **SKF Lubrication Audit:** Detailed assessment. Normally implies five days and provides a thorough analysis of the lubrication programme
- **Improvement proposal:** Formulation of specific activities
- **Design and implementation:** Execution of the proposed activities
- **Optimisation:** Reassessment and implementation of additional improvement proposals

SKF lubricants



SKF lubricants offer major competitive advantages:

- Designed and tested to perform under real conditions
- Product data include specific test results enabling a better selection
- Strict quality control of every production batch helps ensure consistent performance
- Quality control allows SKF to offer a five-year shelf-life* from the date of production



Production processes and raw materials greatly influence grease properties and performance. It is virtually impossible to select or compare greases based only on their composition. Therefore, performance tests are needed to provide crucial information. In over 100 years, SKF has accrued vast knowledge about the interaction of lubricants, materials and surfaces.



This knowledge has led SKF, in many cases, to set industry standards in bearing lubricant testing. Emcor, ROF, ROF+, V2F, R2F and Bequiet are just some of the multiple tests developed by SKF to assess the performance of lubricants under bearing operating conditions. Many of them are widely used by lubricant manufacturers worldwide.

SKF Engineering and Research Centre in the Netherlands

* SKF LGFP 2 food grade grease offers a two-year shelf-life from the date of production

SKF lubricant selection

Selecting a grease can be a delicate process. SKF has developed several tools in order to facilitate the selection of the most suitable lubricant. The wide range of tools available includes those from easy-to-use application driven tables to advanced software allowing for grease selection based upon detailed working conditions.

The basic bearing grease selection chart provides you with quick suggestions on the most commonly used greases in typical applications.

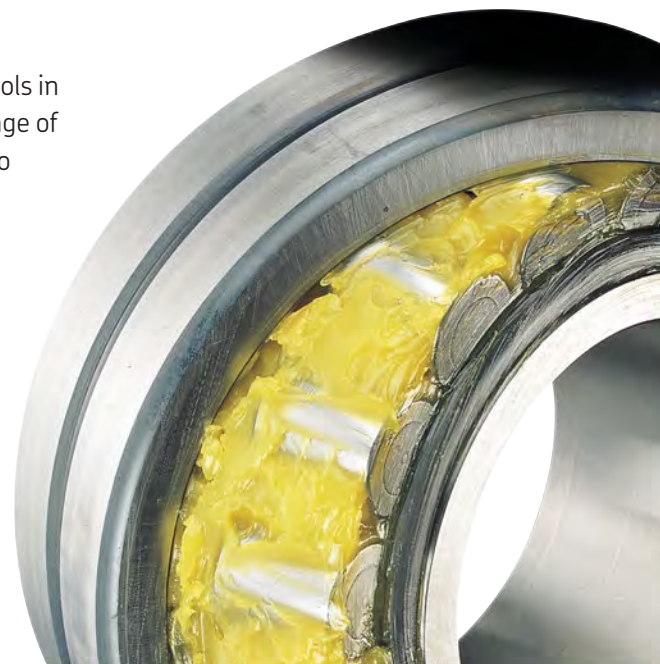

Basic bearing grease selection

Generally use if:

Speed = M, Temperature = M and Load = M

LGMT 2

General purpose

Unless:

Expected bearing temperature continuously >100 °C (210 °F)

LGHP 2

High temperature

Expected bearing temperature continuously >150 °C (300 °F), demands for radiation resistance

LGET 2

Extremely high temperature

Low ambient -50 °C (-60 °F), expected bearing temperature <50 °C (120 °F)

LGLT 2

Low temperature

Shock loads, heavy loads, frequent start-up / shut-down

LGEP 2

High load

Food processing industry

LGFP 2

Food processing

Biodegradable, demands for low toxicity

LGGB 2

Biodegradable

Note: – For areas with relatively high ambient temperatures, use LGMT 3 instead of LGMT 2
– For special operating conditions, refer to the SKF bearing grease selection chart

With additional information like speed, temperature, and load conditions, LubeSelect for SKF greases is the easiest way to select the right grease. For additional information, visit www.apititudeexchange.com. Additionally, the SKF bearing grease selection chart provides you with a complete overview of SKF greases. The chart includes the main selection parameters, such as temperature, speed and load, as well as basic additional performance information.



Bearing operating parameters

Temperature

L	= Low	<50 °C	(120 °F)
M	= Medium	50 to 100 °C	(120 to 230 °F)
H	= High	>100 °C	(210 °F)
EH	= Extremely high	>150 °C	(300 °F)

Load

VH	= Very high	C/P <2
H	= High	C/P ~4
M	= Medium	C/P ~8
L	= Low	C/P ≥15

C/P = Load ratio

C = basic dynamic load rating, kN
P = equivalent dynamic bearing load, kN

Speed

for ball bearings

EH	= Extremely high	n d _m over 700 000
VH	= Very high	n d _m up to 700 000
H	= High	n d _m up to 500 000
M	= Medium	n d _m up to 300 000
L	= Low	n d _m below 100 000

Speed

for roller bearings SRB/TRB/CARB

CRB

H	= High	n d _m over 210 000	n d _m over 270 000
M	= Medium	n d _m up to 210 000	n d _m up to 270 000
L	= Low	n d _m up to 75 000	n d _m up to 75 000
VL	= Very low	n d _m below 30 000	n d _m below 30 000

n d_m = rotational speed, r/min x 0,5 (D+d), mm

SKF bearing grease selection chart

Grease	Description	Application examples	Temperature range ¹⁾		Temp.	Speed
			LTL	HTPL		
LGMT 2	General purpose industrial and automotive	Automotive wheel bearings Conveyors and fans Small electric motors	-30 °C (-20 °F)	120 °C (250 °F)	M	M
LGMT 3	General purpose industrial and automotive	Bearings with d>100 mm Vertical shaft or outer bearing ring rotation Car, truck and trailer wheel bearings	-30 °C (-20 °F)	120 °C (250 °F)	M	M
LGEP 2	Extreme pressure	Forming and press section of paper mills Work roll bearings in steel industry Heavy machinery, vibrating screens	-20 °C (-5 °F)	110 °C (230 °F)	M	L to M
LGWA 2	Wide temperature ⁴⁾ , extreme pressure	Wheel bearings in cars, trailers and trucks Washing machines Electric motors	-30 °C (-20 °F)	140 °C (285 °F)	M to H	L to M
LGFP 2	Food compatible	Food processing equipment Wrapping machines Bottling machines	-20 °C (-5 °F)	110 °C (230 °F)	M	M
LGGB 2	Biodegradable, low toxicity ³⁾	Agricultural and forestry equipment Construction and earthmoving equipment Water treatment and irrigation	-40 °C (-40 °F)	90 °C (195 °F)	L to M	L to M
LGBB 2	Wind turbine blade and yaw bearing grease	Wind turbine blade and yaw slewing bearings	-40 °C (-40 °F)	120 °C (250 °F)	L to M	VL
LGLT 2	Low temperature, extremely high speed	Textile and machine tool spindles Small electric motors and robots Printing cylinders	-50 °C (-60 °F)	110 °C (230 °F)	L to M	M to EH
LGWM 1	Extreme pressure, low temperature	Main shaft of wind turbines Centralised lubrication systems Spherical roller thrust bearing applications	-30 °C (-20 °F)	110 °C (230 °F)	L to M	L to M
LGWM 2	High load, wide temperature	Main shaft of wind turbines Heavy duty off road or marine applications Snow exposed applications	-40 °C (-40 °F)	110 °C (230 °F)	L to M	L to M
LGEM 2	High viscosity plus solid lubricants	Jaw crushers Construction machinery Vibrating machinery	-20 °C (-5 °F)	120 °C (250 °F)	M	VL
LGEV 2	Extremely high viscosity with solid lubricants	Trunnion bearings Support and thrust rollers on rotary kilns and dryers Slewing ring bearings	-10 °C (15 °F)	120 °C (250 °F)	M	VL
LGHB 2	EP high viscosity, high temperature ⁵⁾	Steel on steel plain bearings Dryer section of paper mills Work roll bearings and continuous casting in steel industry Sealed spherical roller bearings up to 150 °C (300 °F)	-20 °C (-5 °F)	150 °C (300 °F)	M to H	VL to M
LGHP 2	High performance polyurea grease	Electric motors Fans, even at high speed High speed ball bearings at medium and high temperatures	-40 °C (-40 °F)	150 °C (300 °F)	M to H	M to H
LGET 2	Extreme temperature	Bakery equipment (ovens) Wafer baking machines Textile dryers	-40 °C (-40 °F)	260 °C (500 °F)	VH	L to M

1) LTL = Low Temperature Limit
HTPL = High Temperature Performance Limit
2) mm²/s at 40 °C (105 °F) = cSt.

3) LGGB 2 can withstand peak temperatures of 120 °C (250 °F)
4) LGWA 2 can withstand peak temperatures of 220 °C (430 °F)
5) LGHB 2 can withstand peak temperatures of 200 °C (390 °F)

Load	Thickener / Base Oil	NLGI	Base oil viscosity 2)	Vertical shaft	Fast outer ring rotation	Oscillating movements	Severe Vibrations	Shock load or frequent start up	Rust inhibiting properties	
L to M	Lithium soap / mineral oil	2	110	●			+		+	Wide applications greases
L to M	Lithium soap / mineral oil	3	120	+	●		+		●	
H	Lithium soap / mineral oil	2	200	●		●	+	+	+	
L to H	Lithium complex soap / mineral oil	2	185	●	●	●	●	+	+	
L to M	Aluminium complex / medical white oil	2	130	●					+	Special requirements
M to H	Lithium-calcium soap / synthetic ester oil	2	110	●		+	+	+	●	
M to H	Lithium complex soap / synthetic PAO oil	2	68			+	+	+	+	
L	Lithium soap / synthetic PAO oil	2	18	●				●	●	Low temperatures
H	Lithium soap / mineral oil	1	200			+		+	+	
L to H	Complex calcium sulphate / synthetic PAO oil / mineral oil	2	80	●	●	+	+	+	+	
H to VH	Lithium soap / mineral oil	2	500	●		+	+	+	+	High loads
H to VH	Lithium-calcium soap / mineral oil	2	1020	●		+	+	+	+	
L to VH	Complex calcium sulphate / mineral oil	2	400	●	+	+	+	+	+	High temperatures
L to M	Di-urea / mineral oil	2 to 3	96	+			●	●	+	
H to VH	PTFE / synthetic fluorinated polyether oil	2	400	●	+	+	●	●	●	

● = Suitable + = Recommended

LGMT 2

General purpose industrial and automotive

LGMT 3

General purpose industrial and automotive

LGEP 2

Extreme pressure

LGWA 2

Wide temperature, extreme pressure

LGFP 2

Food compatible

LGGB 2

Biodegradable, low toxicity

DIN 51825 code	K2K-30	K3K-30	KP2G-20	KP2N-30	K2G-20	KPE 2K-40
NLGI consistency class	2	3	2	2	2	2
Soap type	Lithium	Lithium	Lithium	Lithium complex	Aluminium complex	Lithium/calcium
Colour	Red brown	Amber	Light brown	Amber	Transparent	Off white
Base oil type	Mineral	Mineral	Mineral	Mineral	Medical white oil	Synthetic ester
Operating temperature range	-30 to +120 °C (-20 to +250 °F)	-30 to +120 °C (-20 to +250 °F)	-20 to +110 °C (-5 to +230 °F)	-30 to +140 °C (-20 to +285 °F)	-20 to +110 °C (-5 to +230 °F)	-40 to +90 °C (-40 to +195 °F)
Dropping point DIN ISO 2176	>180 °C (>355 °F)	>180 °C (>355 °F)	>180 °C (>355 °F)	>250 °C (>480 °F)	>250 °C (>480 °F)	>170 °C (>340 °F)
Base oil viscosity 40 °C, mm ² /s 100 °C, mm ² /s	110 11	120-130 12	200 16	185 15	130 7,3	110 13
Penetration DIN ISO 2137 60 strokes, 10 ⁻¹ mm 100 000 strokes, 10 ⁻¹ mm	265-295 +50 max. (325 max.)	220-250 280 max.	265-295 +50 max. (325 max.)	265-295 +50 max. (325 max.)	265-295 +30 max.	265-295 +50 max. (325 max.)
Mechanical stability Roll stability, 50 hrs at 80 °C, 10 ⁻¹ mm V2F test	+50 max. 'M'	295 max. 'M'	+50 max. 'M'	+50 max. change 'M'		+70 max. (350 max.)
Corrosion protection Emcor: - standard ISO 11007 - water washout test - salt water test (100% seawater)	0-0 0-0 0-1*	0-0 0-0	0-0 0-0 1-1*	0-0 0-0*	0-0	0-0
Water resistance DIN 51 807/1, 3 hrs at 90 °C	1 max.	2 max.	1 max.	1 max.	1 max.	0 max.
Oil separation DIN 51 817, 7 days at 40 °C, static, %	1-6	1-3	2-5	1-5	1-5	0,3-3
Lubrication ability R2F, running test B at 120 °C R2F, cold chamber test, -30 °C, +20 °C	Pass, 120 °C (250 °F)	Pass 120 °C (250 °F)	Pass, 120 °C (250 °F)	Pass, 100 °C (210 °F)		Pass, 100 °C (210 °F)*
Copper corrosion DIN 51 811, 110 °C	2 max. 110 °C (265 °F)	2 max. 130 °C (265 °F)	2 max.	2 max.		
Rolling bearing grease life ROF test L ₅₀ life at 10 000 r/min., hrs		1 000 min., 130 °C (265 °F)			1 000, 110 °C (230 °F)	>300, 120 °C (250 °F)
EP performance Wear scar DIN 51350/5, 1 400 N, mm 4-ball test, welding load DIN 51350/4, N			1,4 max 2 800 min.	1,6 max. 2 600 min.	1 100 min.	1,8 max. 2 600 min.
Fretting corrosion ASTM D4170 FAFNIR test at -20 °C, +25 °C mg			5,7*			
Low temperature torque IP186, starting torque, m Nm* IP186, running torque, m Nm*	98, -30 °C (-20 °F) 58, -30 °C (-20 °F)	145, -30 °C (-20 °F) 95, -30 °C (-20 °F)	70, -20 °C (-5 °F) 45, -20 °C (-5 °F)	40, -30 °C (-20 °F) 30, -30 °C (-20 °F)	137, -30 °C (-20 °F) 51, -30 °C (-20 °F)	
Available pack sizes	35, 200 g tube 420 ml cartridge 1, 5, 18, 50, 180 kg	420 ml cartridge 0,5, 1, 5, 18, 50, 180 kg, TLMR	420 ml cartridge 1, 5, 18, 50, 180 kg TLMR	35, 200 g tube 420 ml cartridge 1, 5, 18, 50, 180 kg LAGD, TBSD, TLMR	420 ml cartridge 1, 18, 180 kg LAGD, TBSD, TLMR	420 ml cartridge 5, 18, 180 kg LAGD

* Typical value

Special requirements

Wide applications greases

LGBB 2 **LGLT 2** **LGWM 1** **LGWM 2** **LGEM 2** **LGEV 2** **LGHB 2** **LGHP 2** **LGET 2**

Wind turbine blade and yaw bearing grease Low temperature, extremely high speed Extreme pressure, low temperature High load, wide temperature High viscosity plus solid lubricants Extremely high viscosity with solid lubricants EP high viscosity, high temperature High performance polyurea grease Extreme temperature

KP2G-40	K2G-50	KP1G-30	KP2G-40	KPF2K-20	KPF2K-10	KP2N-20	K2N-40	KFK2U-40
2	2	1	1-2	2	2	2	2-3	2
Lithium complex	Lithium	Lithium	Complex calcium sulphonate	Lithium	Lithium/calcium	Complex calcium sulphonate	Di-urea	PTFE
Yellow	Beige	Brown	Yellow	Black	Black	Brown	Blue	Off white
Synthetic (PAO)	Synthetic (PAO)	Mineral	Synthetic (PAO)/Mineral	Mineral	Mineral	Mineral	Mineral	Synthetic (fluorinated polyether)
-40 to +120 °C (-40 to +250 °F)	-50 to +110 °C (-60 to +230 °F)	-30 to +110 °C (-20 to +230 °F)	-40 to +110 °C (-40 to +230 °F)	-20 to +120 °C (-5 to +250 °F)	-10 to +120 °C (15 to 250 °F)	-20 to +150 °C (-5 to +300 °F)	-40 to +150 °C (-40 to +300 °F)	-40 to +260 °C (-40 to +500 °F)
>200 °C (390 °F)	>180 °C (>355 °F)	>170 °C (>340 °F)	>300 °C (>570 °F)	>180 °C (>355 °F)	>180 °C (>355 °F)	>220 °C (>430 °F)	>240 °C (>465 °F)	>300 °C (>570 °F)
68	18 4,5	200 16	80 8,6	500 32	1 020 58	400-450 26,5	96 10,5	400 38
265-295 +50 max.	265-295 +50 max.	310-340 +50 max.	280-310 +30 max.	265-295 325 max.	265-295 325 max.	265-295 -20 to +50 (325 max.)	245-275 365 max.	265-295 -
+50 max.	380 max.		+50 max.	345 max. 'M'	+50 max. 'M'	-20 to +50 change 'M'	365 max.	±30 max. 130 °C (265 °F)
0-0 0-1*	0-1	0-0 0-0	0-0 0-0 0-0	0-0 0-0	0-0 0-0*	0-0 0-0 0-0*	0-0 0-0 0-0	1-1
1 max.	1 max.	1 max.	1 max.	1 max.	1 max.	1 max.	1 max.	0 max.
4 max, 2,5*	<4	8-13	3 max.	1-5	1-5	1-3, 60 °C (140 °F)	1-5	13 max. 30 hrs 200 °C (390 °F)
			Pass, 140 °C (285 °F) Pass, Pass	Pass, 100 °C (210 °F)		Pass, 140 °C (285 °F)	Pass, 120 °C (250 °F)	
1 max. 120 °C (250 °F)	1 max. 100 °C (210 °F)	2 max. 90 °C (>195 °F)	1 max.	2 max. 100 °C (210 °F)	1 max. 100 °C (210 °F)	2 max. 150 °C (300 °F)	1 max. 150 °C (300 °F)	1
	>1 000, 20 000 r/min. 100 °C (210 °F)		1 824*, 110 °C (230 °F)			>1 000, 130 °C (265 °F)	1 000 min. 150 °C (300 °F)	>700, 5 600 r/min.* 220 °C (430 °F)
0,4* 5 500*	2 000 min.	1,8 max. 3 200 min.*	1,5 max. 4 000 min.	1,4 max. 3 000 min.	1,2 max. 3 000 min.	0,86* 4 000 min.		8 000 min.
0-1*		5,5*	1,1*, 5,2*			0*	7*	
313, -40 °C (-40 °F) 75, -40 °C (-40 °F)	32, -50 °C (-60 °F) 21, -50 °C (-60 °F)	178, 0 °C (32 °F) 103, 0 °C (32 °F)	249, -40 °C (-40 °F) 184, -40 °C (-40 °F)	160, -20 °C (-5 °F) 98, -20 °C (-5 °F)	96, -10 °C (14 °F) 66, -10 °C (14 °F)	250, -20 °C (-5 °F) 133, -20 °C (-5 °F)	1 000, -40 °C (-40 °F) 280, -40 °C (-40 °F)	
420 ml cartridge 5, 18, 180 kg	180 g tube 0,9, 25, 170 kg	420 ml cartridge 5, 50, 180 kg TLMR	420 ml cartridge 5, 18, 50, 180 kg LAGD, TLSD, TLMR	420 ml cartridge 5, 18, 180 kg LAGD, TLSD	35 g tube 420 ml cartridge 5, 18, 50, 180 kg TLMR	420 ml cartridge 5, 18, 50, 180 kg LAGD, TLSD, TLMR	420 ml cartridge 1, 5, 18, 50, 180 kg LAGD, TLSD, TLMR	50 g (25 ml) syringe 1 kg

High loads

Low temperatures

High temperatures

Bearing greases

LGMT 2

SKF General Purpose Industrial and Automotive Bearing Grease

SKF LGMT 2 is mineral oil based, lithium soap thickened grease with excellent thermal stability within its operating temperature range. This premium quality, general purpose grease is suitable for a wide range of industrial and automotive applications.

- Excellent oxidation stability
- Good mechanical stability
- Excellent water resistance and rust inhibiting properties

Typical applications:

- Agricultural equipment
- Automotive wheel bearings
- Conveyors
- Small electric motors
- Industrial fans



Technical data

Designation	LGMT 2/(pack size)
DIN 51825 code	K2K-30
NLGI consistency class	2
Soap type	Lithium
Colour	Red brown
Base oil type	Mineral
Operating temperature range	-30 to +120 °C (-20 to +250 °F)
Dropping point DIN ISO 2176	>180 °C (>355 °F)
Base oil viscosity	
40 °C, mm ² /s	110
100 °C, mm ² /s	11
Penetration DIN ISO 2137	
60 strokes, 10 ⁻¹ mm	265-295
100 000 strokes, 10 ⁻¹ mm	+50 max. (325 max.)
Mechanical stability	
Roll stability,	
50 hrs at 80 °C, 10 ⁻¹ mm	+50 max.
V2F test	'M'
Corrosion protection	
Emcor:	
- standard ISO 11007	0-0
- water washout test	0-0
- salt water test (100% seawater)	0-1*
Water resistance	
DIN 51 807/1,	
3 hrs at 90 °C	1 max.
Oil separation	
DIN 51 817,	
7 days at 40 °C, static, %	1-6
Lubrication ability	
R2F,	
running test B at 120 °C	Pass
Copper corrosion	
DIN 51 811, 110 °C	2 max. at 110 °C (265 °F)
Available pack sizes	
	35, 200 g tube
	420 ml cartridge
	1, 5, 18, 50, 180 kg

* Typical value

LGMT 3

SKF General Purpose Industrial and Automotive Bearing Grease

SKF LGMT 3 is mineral oil based, lithium soap thickened grease. This premium quality, general purpose grease is suitable for a wide range of industrial and automotive applications requiring stiff grease.

- Excellent rust inhibiting properties
- High oxidation stability within its recommended temperature range

Typical applications:

- Bearings >100 mm (3.9 in.) shaft size
- Outer bearing ring rotation
- Vertical shaft applications
- Continuous high ambient temperatures >35 °C (95 °F)
- Propeller shafts
- Agricultural equipment
- Car, truck and trailer wheel bearings
- Large electric motors



Technical data

Designation LGMT 3/(pack size)

DIN 51825 code	K3K-30
NLGI consistency class	3
Soap type	Lithium
Colour	Amber
Base oil type	Mineral
Operating temperature range	-30 to +120 °C (-20 to +250 °F)
Dropping point DIN ISO 2176	>180 °C (>355 °F)
Base oil viscosity	
40 °C, mm ² /s	120-130
100 °C, mm ² /s	12
Penetration DIN ISO 2137	
60 strokes, 10 ⁻¹ mm	220-250
100 000 strokes, 10 ⁻¹ mm	280 max.
Mechanical stability	
Roll stability, 50 hrs at 80 °C, 10 ⁻¹ mm	295 max.
V2F test	'M'

Corrosion protection

Emcor: - standard ISO 11007	0-0
- water washout test	0-0

Water resistance

DIN 51 807/1, 3 hrs at 90 °C	2 max.
---------------------------------	--------

Oil separation

DIN 51 817, 7 days at 40 °C, static, %	1-3
---	-----

Lubrication ability

R2F, running test B at 120 °C	Pass
----------------------------------	------

Copper corrosion

DIN 51 811, 110 °C	2 max. at 130 °C (265 °F)
--------------------	---------------------------

Rolling bearing grease life

ROF test	1 000 min. at 130 °C (265 °F)
L ₅₀ life at 10 000 r/min., hrs	

Available pack sizes

420 ml cartridge	
0,5, 1, 5, 18, 50, 180 kg	
TLMR	

LGEP 2

SKF High Load, Extreme Pressure Bearing Grease

SKF LGEP 2 is mineral oil based, lithium soap thickened grease with extreme pressure additives. This grease provides good lubrication in general applications subjected to harsh conditions and vibrations.

- Excellent mechanical stability
- Extremely good corrosion inhibiting properties
- Excellent EP performance

Typical applications:

- Pulp and paper making machines
- Jaw crushers
- Traction motors for rail vehicles
- Dam gates
- Work roll bearings in steel industry
- Heavy machinery, vibrating screens
- Crane wheels, sheaves
- Slewing bearings



Technical data

Designation LGEP 2/(pack size)

DIN 51825 code	KP2G-20
NLGI consistency class	2
Soap type	Lithium
Colour	Light brown
Base oil type	Mineral
Operating temperature range	-20 to +110 °C (-5 to +230 °F)
Dropping point DIN ISO 2176	>180 °C (>355 °F)
Base oil viscosity:	
40 °C, mm ² /s	200
100 °C, mm ² /s	16
Penetration DIN ISO 2137	
60 strokes, 10 ⁻¹ mm	265-295
100 000 strokes, 10 ⁻¹ mm	+50 max. (325 max.)
Mechanical stability:	
Roll stability, 50 hrs at 80 °C, 10 ⁻¹ mm	+50 max.
V2F test	'M'
Corrosion protection	
Emcor: - standard ISO 11007	0-0
- water washout test	0-0
- salt water test (100% seawater)	1-1*

Water resistance	
DIN 51 807/1, 3 hrs at 90 °C	1 max.
Oil separation	
DIN 51 817, 7 days at 40 °C, static, %	2-5
Lubrication ability	
R2F, running test B at 120 °C	Pass
Copper corrosion	
DIN 51 811, 110 °C	2 max.
EP performance	
Wear scar DIN 51350/5, 1 400 N, mm	1,4 max
4-ball test, welding load DIN 51350/4, N	2 800 min.
Fretting corrosion	
ASTM D4170 (mg)	5,7*
Available pack sizes	420 ml cartridge 1, 5, 18, 50, 180 kg TLMR

* Typical value

LGWA 2

SKF High Load, Extreme Pressure, Wide Temperature Range Bearing Grease

SKF LGWA 2 is a premium quality mineral oil based, lithium complex grease with extreme pressure (EP) performance. LGWA 2 is recommended for general industrial and automotive applications, when loads or temperatures exceed the range of general purpose greases.

- Excellent lubrication at peak temperatures up to 220 °C (430 °F) for short periods
- Protection of wheel bearings operating under severe conditions
- Effective lubrication in wet conditions
- Good water and corrosion resistance
- Excellent lubrication under high loads and low speeds

Typical applications:

- Wheel bearings in cars, trailers and trucks
- Washing machines
- Fan and electric motors



Technical data

Designation **LGWA 2/(pack size)**

DIN 51825 code	KP2N-30
NLGI consistency class	2
Soap type	Lithium complex
Colour	Amber
Base oil type	Mineral
Operating temperature range	-30 to +140 °C (-20 to +285 °F)
Dropping point DIN ISO 2176	>250 °C (>480 °F)
Base oil viscosity	
40 °C, mm ² /s	185
100 °C, mm ² /s	15
Penetration DIN ISO 2137	
60 strokes, 10 ⁻¹ mm	265-295
100 000 strokes, 10 ⁻¹ mm	+50 max. (325 max.)
Mechanical stability	
Roll stability, 50 hrs at 80 °C, 10 ⁻¹ mm V2F test	+50 max. change 'M'
Corrosion protection	
Emcor: - standard ISO 11007	0-0
- water washout test	0-0*

Water resistance	
DIN 51 807/1, 3 hrs at 90 °C	1 max.
Oil separation	
DIN 51 817, 7 days at 40 °C, static, %	1-5
Lubrication ability	
R2F, running test B at 120 °C	Pass at 100 °C (210 °F)
Copper corrosion	
DIN 51 811, 110 °C	2 max.
EP performance	
Wear scar DIN 51350/5, 1 400 N, mm	1,6 max.
4-ball test, welding load DIN 51350/4, N	2 600 min.
Available pack sizes	35, 200 g tube 420 ml cartridge 1, 5, 18, 50, 180 kg SKF SYSTEM 24 (LAGD/TLSD), TLMR

* Typical value

LGGB 2

SKF Biodegradable Bearing Grease

SKF LGGB 2 is a biodegradable, low toxicity, synthetic ester oil based grease, using a lithium-calcium thickener. Its special formulation makes it most suitable for applications where environmental contamination is a concern.

- Compliance with current regulations on toxicity and biodegradability
- Good performance in applications with steel-on-steel spherical plain bearings, ball bearings and roller bearings
- Good low temperature start-up performance
- Good corrosion inhibiting properties
- Suitable for medium to high loads

Typical applications:

- Agricultural and forestry equipment
- Construction and earthmoving equipment
- Mining and conveying equipment
- Water treatment and irrigation
- Locks, dams, bridges
- Linkages, rod ends



Technical data

Designation	LGGB 2/(pack size)
-------------	--------------------

DIN 51825 code	KPE 2K-40
NLGI consistency class	2
Soap type	Lithium/calcium
Colour	Off white
Base oil type	Synthetic ester
Operating temperature range	-40 to +90 °C (-40 to +195 °F)
Dropping point DIN ISO 2176	>170 °C (>340 °F)
Base oil viscosity	
40 °C, mm ² /s	110
100 °C, mm ² /s	13
Penetration DIN ISO 2137	
60 strokes, 10 ⁻¹ mm	265–295
100 000 strokes, 10 ⁻¹ mm	+50 max. (325 max.)
Mechanical stability	
Roll stability, 50 hrs at 80 °C, 10 ⁻¹ mm	+70 max. (350 max.)

Corrosion protection	
Emcor: – standard ISO 11007	0–0
Water resistance	
DIN 51 807/1, 3 hrs at 90 °C	0 max.
Oil separation	
DIN 51 817, 7 days at 40 °C, static, %	0,3–3
Lubrication ability	
R2F, running test B at 120 °C	Pass at 100 °C (210 °F)*
Rolling bearing grease life	
ROF test L ₅₀ life at 10 000 r/min., hrs	>300 at 120 °C (250 °F)
EP performance	
Wear scar DIN 51350/5, 1 400 N, mm	1,8 max.
4–ball test, welding load DIN 51350/4, N	2 600 min.
Available pack sizes	420 ml cartridge 5, 18, 180 kg SKF SYSTEM 24 (LAGD)

* Typical value

LGBB 2

SKF Wind Turbine Blade and Yaw Bearing Grease

SKF LGBB 2 is a lithium complex/synthetic PAO oil based grease specially designed for extreme conditions involving very low speeds, high loads, low temperatures and oscillating conditions. This grease provides proper lubrication whether the turbine is operating or in stand-still mode, installed onshore, offshore, or in cold climate areas.

- Excellent false brinelling protection
- Excellent performance under high loads
- Excellent performance at low temperature starting torque
- Good pumpability down to low temperatures
- Excellent water resistance
- Excellent corrosion protection
- High thermal and mechanical stability

Typical applications:

- Wind turbine blade and yaw bearing applications



Technical data

Designation LGBB 2/(pack size)

DIN 51825 code	KP2G-40
NLGI consistency class	2
Soap type	Lithium complex
Colour	Yellow
Base oil type	Synthetic (PAO)
Operating temperature range	-40 to +120 °C (-40 to +250 °F)
Dropping point DIN ISO 2176	>200 °C (390 °F)
Base oil viscosity 40 °C, mm ² /s	68
Penetration DIN ISO 2137 60 strokes, 10 ⁻¹ mm 100 000 strokes, 10 ⁻¹ mm	265-295 +50 max.
Mechanical stability Roll stability, 50h at 80 °C, 10 ⁻¹ mm	+50 max.
Corrosion protection Emcor: - Standard ISO 11007 - Salt water test (100% sea water)	0-0 0-1*

Water resistance DIN 51 807/1, 3 hours at 90 °C	1 max.
Oil separation DIN 51817, 7 days at 40 °C, static, %	4 max, 2.5*
Copper corrosion DIN 51 811, 120 °C	1 max.
EP performances Wear scar DIN 51350/5, 1400 N, mm 4-ball test, welding load DIN 51350/4, N	0.4 * 5 500 *
Rolling bearing lubrication ability Fe8, DIN 51819, 80 kN, 80 °C, C/P 1.8, 500 h	pass
False brinelling resistance ASTM D4170 FAFNIR test, mg	0-1*
Available packsizes	420 ml cartridge 5, 18, 180 kg

* Typical value

LGLT 2

SKF Low Temperature, Extremely High Speed Bearing Grease

SKF LGLT 2 is a fully synthetic oil based grease using lithium soap. Its unique thickener technology and low viscosity oil (PAO) provide excellent lubrication performances at low temperatures $-50\text{ }^{\circ}\text{C}$ ($-60\text{ }^{\circ}\text{F}$) and extremely high speeds (n_{d_m} values of $1,6 \times 10^6$ can be reached).

- Low friction torque
- Quiet running
- Extremely good oxidation stability and resistance to water

Typical applications:

- Textile spinning spindles
- Machine tool spindles
- Instruments and control equipment
- Small electric motors used in medical and dental equipment
- In-line skates
- Printing cylinders
- Robots



Technical data

Designation	LGLT 2/(pack size)					
DIN 51825 code	K2G-50					
NLGI consistency class	2					
Soap type	Lithium					
Colour	Beige					
Base oil type	Synthetic (PAO)					
Operating temperature range	-50 to $+110\text{ }^{\circ}\text{C}$ (-60 to $+230\text{ }^{\circ}\text{F}$)					
Dropping point DIN ISO 2176	$>180\text{ }^{\circ}\text{C}$ ($>355\text{ }^{\circ}\text{F}$)					
Base oil viscosity	<table border="0"> <tr> <td>40 °C, mm²/s</td> <td>18</td> </tr> <tr> <td>100 °C, mm²/s</td> <td>4,5</td> </tr> </table>		40 °C, mm ² /s	18	100 °C, mm ² /s	4,5
40 °C, mm ² /s	18					
100 °C, mm ² /s	4,5					
Penetration DIN ISO 2137	<table border="0"> <tr> <td>60 strokes, 10⁻¹ mm</td> <td>265–295</td> </tr> <tr> <td>100 000 strokes, 10⁻¹ mm</td> <td>+50 max.</td> </tr> </table>		60 strokes, 10 ⁻¹ mm	265–295	100 000 strokes, 10 ⁻¹ mm	+50 max.
60 strokes, 10 ⁻¹ mm	265–295					
100 000 strokes, 10 ⁻¹ mm	+50 max.					
Mechanical stability	<table border="0"> <tr> <td>Roll stability, 50 hrs at 80 °C, 10⁻¹ mm</td> <td>380 max.</td> </tr> </table>		Roll stability, 50 hrs at 80 °C, 10 ⁻¹ mm	380 max.		
Roll stability, 50 hrs at 80 °C, 10 ⁻¹ mm	380 max.					
Corrosion protection	Emcor: – standard ISO 11007	0–1				
Water resistance	DIN 51 807/1, 3 hrs at 90 °C	1 max.				
Oil separation	DIN 51 817, 7 days at 40 °C, static, %	<4				
Copper corrosion	DIN 51 811, 110 °C	1 max. at 100 °C (210 °F)				
Rolling bearing grease life	ROF test	>1 000,				
	L ₅₀ life at 10 000 r/min., hrs	20 000 r/min. at 100 °C (210 °F)				
EP performance	4–ball test, welding load DIN 51350/4, N	2 000 min.				
Available pack sizes	180 g tube 0,9, 25, 170 kg					

LGWM 1

SKF Extreme Pressure Low Temperature Bearing Grease

SKF LGWM 1 is a low consistency mineral oil based grease, using a lithium soap and containing extreme pressure additives. It is extremely suitable for the lubrication of bearings operating under both radial and axial loads.

- Good oil film formation at low temperatures down to $-30\text{ }^{\circ}\text{C}$ ($-20\text{ }^{\circ}\text{F}$)
- Good pumpability down to low temperatures
- Good corrosion protection
- Good water resistance

Typical applications:

- Wind turbine main shafts
- Screw conveyors
- Centralised lubrication systems
- Spherical roller thrust bearing applications



Technical data

Designation **LGWM 1/(pack size)**

DIN 51825 code	KP1G-30
NLGI consistency class	1
Soap type	Lithium
Colour	Brown
Base oil type	Mineral
Operating temperature range	-30 to $+110\text{ }^{\circ}\text{C}$ (-20 to $+230\text{ }^{\circ}\text{F}$)
Dropping point DIN ISO 2176	$>170\text{ }^{\circ}\text{C}$ ($>340\text{ }^{\circ}\text{F}$)
Base oil viscosity	
40 $^{\circ}\text{C}$, mm^2/s	200
100 $^{\circ}\text{C}$, mm^2/s	16
Penetration DIN ISO 2137	
60 strokes, 10^{-1} mm	310-340
100 000 strokes, 10^{-1} mm	+50 max.
Corrosion protection:	
Emcor: - standard ISO 11007	0-0
- water washout test	0-0

Water resistance	
DIN 51 807/1, 3 hrs at $90\text{ }^{\circ}\text{C}$	1 max.
Oil separation	
DIN 51 817, 7 days at $40\text{ }^{\circ}\text{C}$, static, %	8-13
Copper corrosion	
DIN 51 811, $110\text{ }^{\circ}\text{C}$	2 max. at $90\text{ }^{\circ}\text{C}$ ($>195\text{ }^{\circ}\text{F}$)
EP performance	
Wear scar DIN 51350/5, 1 400 N, mm	1,8 max.
4-ball test, welding load DIN 51350/4, N	3 200 min.*
Fretting corrosion	
ASTM D4170 (mg)	5,5*
Available pack sizes	420 ml cartridge 5, 50, 180 kg TLMR

* Typical value

LGWM 2

SKF High Load, Wide Temperature Bearing Grease

SKF LGWM 2 is a synthetic-mineral oil based grease using the latest complex calcium sulphonate thickener technology. It is suitable for applications subjected to high loads, wet environments and fluctuating temperatures.

- Excellent corrosion protection
- Excellent mechanical stability
- Excellent high load lubricating capacity
- Good false brinelling protection
- Good pumpability down to low temperatures

Typical applications:

- Wind turbine mains shafts
- Heavy duty off road applications
- Snow exposed applications
- Marine and offshore applications
- Spherical roller thrust bearing applications



Technical data

Designation **LGWM 2/(pack size)**

DIN 51825 code	KP2G-40
NLGI consistency class	1-2
Soap type	Complex calcium sulphonate
Colour	Yellow
Base oil type	Synthetic (PAO)/ Mineral
Operating temperature range	-40 to +110 °C (-40 to +230 °F)
Dropping point DIN ISO 2176	>300 °C (>570 °F)
Base oil viscosity	
40 °C, mm ² /s	80
100 °C, mm ² /s	8,6
Penetration DIN ISO 2137	
60 strokes, 10 ⁻¹ mm	280-310
100 000 strokes, 10 ⁻¹ mm	+30 max.
Mechanical stability	
Roll stability, 50 hrs at 80 °C, 10 ⁻¹ mm	+50 max.
Corrosion protection	
Emcor: - standard ISO 11007	0-0
- water washout test	0-0
- salt water test (100% seawater)	0-0

Water resistance

DIN 51 807/1,
3 hrs at 90 °C 1 max.

Oil separation

DIN 51 817,
7 days at 40 °C, static, % 3 max.

Lubrication ability

R2F, running test B at 120 °C Pass at 140 °C (285 °F)
R2F, Cold chamber test (+20 °C) Pass
R2F, Cold chamber test (-30 °C) Pass

Copper corrosion

DIN 51 811, 110 °C 1 max.

Rolling bearing grease life

ROF test
L₅₀ life at 10 000 r/min., hrs 1 824* at 110 °C (230 °F)

EP performance

Wear scar DIN 51350/5, 1 400 N, mm 1,5 max.
4-ball test, welding load DIN 51350/4, N 4 000 min.

Fretting corrosion

ASTM D4170 FAFNIR test at +25 °C, mg 5,2*
ASTM D4170 FAFNIR test at -20 °C, mg 1,1*

Available pack sizes

420 ml cartridge
5, 18, 50, 180 kg
SKF SYSTEM 24
(LAGD/TLSD), TLMR

* Typical value

LGEM 2

SKF High Viscosity Bearing Grease with Solid Lubricants

SKF LGEM 2 is a high viscosity, mineral oil based grease using a lithium soap. Its content of molybdenum disulphide and graphite provides extra protection for harsh applications subjected to high loads, heavy vibrations and slow rotations.

- High oxidation stability
- Molybdenum disulphide and graphite provide lubrication even if the oil film breaks down

Typical applications:

- Rolling element bearings running at low speed and very high loads
- Jaw crushers
- Track laying machines
- Lift mast wheels
- Building machines such as mechanical rams, crane arms and crane hooks



Technical data

Designation **LGEM 2/(pack size)**

DIN 51825 code KPF2K-20

NLGI consistency class 2

Soap type Lithium

Colour Black

Base oil type Mineral

Operating temperature range
-20 to +120 °C
(-5 to +250 °F)

Dropping point DIN ISO 2176 >180 °C (>355 °F)

Base oil viscosity
40 °C, mm²/s 500
100 °C, mm²/s 32

Penetration DIN ISO 2137
60 strokes, 10⁻¹ mm 265–295
100 000 strokes, 10⁻¹ mm 325 max.

Mechanical stability
Roll stability, 50 hrs at 80 °C, 10⁻¹ mm 345 max.
V2F test 'M'

Corrosion protection

Emcor: – standard ISO 11007 0–0
– water washout test 0–0

Water resistance

DIN 51 807/1,
3 hrs at 90 °C 1 max.

Oil separation

DIN 51 817,
7 days at 40 °C, static, % 1–5

Lubrication ability

R2F, running test B at 120 °C Pass at 100 °C (210 °F)

Copper corrosion

DIN 51 811, 110 °C 2 max. at 100 °C (210 °F)

EP performance

Wear scar DIN 51350/5, 1 400 N, mm 1,4 max.
4–ball test, welding load DIN 51350/4, N 3 000 min.

Available pack sizes

420 ml cartridge
5, 18, 180 kg
SKF SYSTEM 24
(LAGD/TLSD)

LGEV 2

SKF Extremely High Viscosity Bearing Grease with Solid Lubricants

SKF LGEV 2 is a mineral oil based grease, using a lithium-calcium soap. Its high content of molybdenum disulphide and graphite, in conjunction with an extremely high viscosity oil, provide outstanding protection under the harshest conditions involving high loads, slow rotations and severe vibrations.

- Extremely suitable for lubricating large sized spherical roller bearings subject to high loads and slow rotations, a situation where microslip is likely to occur
- Extremely mechanically stable providing good water resistance and corrosion protection

Typical applications:

- Trunnion bearings on rotating drums
- Support and thrust rollers on rotary kilns and dryers
- Bucket wheel excavators
- Slewing ring bearings
- High pressure roller mills
- Crushers



Technical data

Designation	LGEV 2/(pack size)
DIN 51825 code	KPF2K-10
NLGI consistency class	2
Soap type	Lithium/calcium
Colour	Black
Base oil type	Mineral
Operating temperature range	-10 to +120 °C (15 to 250 °F)
Dropping point DIN ISO 2176	>180 °C (>355 °F)
Base oil viscosity	
40 °C, mm ² /s	1 020
100 °C, mm ² /s	58
Penetration DIN ISO 2137	
60 strokes, 10 ⁻¹ mm	265–295
100 000 strokes, 10 ⁻¹ mm	325 max.
Mechanical stability	
Roll stability, 72 hrs at 100 °C, 10 ⁻¹ mm	+50 max.
V2F test	'M'

Corrosion protection	
Emcor: – standard ISO 11007	0–0
– water washout test	0–0*
– salt water test (100% seawater)	0–0*
Water resistance	
DIN 51 807/1, 3 hrs at 90 °C	1 max.
Oil separation	
DIN 51 817, 7 days at 40 °C, static, %	1–5
Copper corrosion	
DIN 51 811, 110 °C	1 max. at 100 °C (210 °F)
EP performance	
Wear scar DIN 51350/5, 1 400 N, mm	1,2 max.
4–ball test, welding load DIN 51350/4	3 000 min.
Available pack sizes	35 g tube 420 ml cartridge 5, 18, 50, 180 kg TLMR

* Typical value

LGHB 2

SKF High Load, High Temperature, High Viscosity Bearing Grease

SKF LGHB 2 is a high viscosity, mineral oil based grease, using the latest complex calcium-sulphonate soap technology. Formulated to withstand high temperatures and extreme loads, it is suitable for a wide range of applications, especially in the cement, mining and metals segments. This grease contains no additives and the extreme pressure properties arise from the soap structure.

- Excellent anti-oxidation and anti-corrosion properties
- Excellent performance in applications running at high loads
- Withstands peak temperatures of 200 °C (390 °F)

Typical applications:

- Steel on steel plain bearings
- Pulp and paper making machines
- Asphalt vibrating screens
- Continuous casting machines
- Sealed spherical roller bearings operating up to 150 °C (300 °F)
- Work roll bearings in steel industry
- Mast rollers of fork lift trucks



Technical data

Designation **LGHB 2/(pack size)**

DIN 51825 code	KP2N-20
NLGI consistency class	2
Soap type	Complex calcium sulphonate
Colour	Brown
Base oil type	Mineral
Operating temperature range	-20 to +150 °C (-5 to +300 °F)
Dropping point DIN ISO 2176	>220 °C (>430 °F)
Base oil viscosity	
40 °C, mm ² /s	400-450
100 °C, mm ² /s	26,5
Penetration DIN ISO 2137	
60 strokes, 10 ⁻¹ mm	265-295
100 000 strokes, 10 ⁻¹ mm	-20 to +50 (325 max.)
Mechanical stability	
Roll stability, 72 hrs at 100 °C, 10 ⁻¹ mm V2F test	-20 to +50 change 'M'
Corrosion protection	
Emcor: - standard ISO 11007	0-0
- water washout test	0-0
- salt water test (100% seawater)	0-0*

Water resistance	
DIN 51 807/1, 3 hrs at 90 °C	1 max.
Oil separation	
DIN 51 817, 7 days at 40 °C, static, %	1-3 at 60 °C (140 °F)
Lubrication ability	
R2F, running test B at 120 °C	Pass at 140 °C (285 °F)
Copper corrosion	
DIN 51 811, 110 °C	2 max. at 150 °C (300 °F)
Rolling bearing grease life	
ROF test	
L ₅₀ life at 10 000 r/min., hrs	>1 000 at 130 °C (265 °F)
EP performance	
Wear scar DIN 51350/5, 1 400 N, mm	0,86*
4-ball test, welding load DIN 51350/4, N	4 000 min.
Fretting corrosion	
ASTM D4170 (mg)	0*
Available pack sizes	420 ml cartridge 5, 18, 50, 180 kg SKF SYSTEM 24 (LAGD/TLSD), TLMR

* Typical value

LGHP 2

SKF High Performance, High Temperature Bearing Grease

SKF LGHP 2 is a premium quality mineral oil based grease, using a modern Polyurea (di-urea) thickener. It is suitable for electric motors and similar applications.

- Extremely long life at high temperatures
- Wide temperature range
- Excellent corrosion protection
- High thermal and mechanical stability
- Good start-up performance at low temperatures
- Compatibility with common polyurea and lithium thickened greases
- Low noise properties

Typical applications:

- Electric motors: Small, medium and large
- Industrial fans, including high speed fans
- Water pumps
- Rolling bearings in textile, paper processing and drying machines
- Applications with medium and high speed ball (and roller) bearings operating at medium and high temperatures
- Clutch release bearings
- Vertical shaft applications
- Kiln trucks and rollers



Technical data

Designation	LGHP 2/(pack size)	
DIN 51825 code	K2N-40	
NLGI consistency class	2-3	
Soap type	Di-urea	
Colour	Blue	
Base oil type	Mineral	
Operating temperature range	-40 to +150 °C (-40 to +300 °F)	
Dropping point DIN ISO 2176	>240 °C (>465 °F)	
Base oil viscosity	40 °C, mm ² /s	96
	100 °C, mm ² /s	10,5
Penetration DIN ISO 2137	60 strokes, 10 ⁻¹ mm	245-275
	100 000 strokes, 10 ⁻¹ mm	365 max.
	Mechanical stability	
Roll stability, 50 hrs at 80 °C, 10 ⁻¹ mm	365 max.	
Corrosion protection	Emcor: - standard ISO 11007	0-0
	- water washout test	0-0
	- salt water test (100% seawater)	0-0
	Water resistance	DIN 51 807/1, 3 hrs at 90 °C
Oil separation	DIN 51 817, 7 days at 40 °C, static, %	1-5
	Lubrication ability	R2F, running test B at 120 °C
Copper corrosion	DIN 51 811, 110 °C	1 max. at 150 °C (300 °F)
	Rolling bearing grease life	ROF test
L ₅₀ life at 10 000 r/min., hrs		at 150 °C (300 °F)
Fretting corrosion	ASTM D4170 (mg)	7*
Available pack sizes	420 ml cartridge	
	1, 5, 18,	
	50, 180 kg	
	SKF SYSTEM 24 (LAGD/TLSD), TLMR	

* Typical value

LGET 2

SKF Extreme Temperature, Extreme Condition Bearing Grease

SKF LGET 2 is a synthetic fluorinated oil based grease, using a PTFE thickener. It is especially suitable for applications at extremely high temperatures from 200 °C (390 °F) up to 260 °C (500 °F).

- Long life in aggressive environments such as very reactive areas with a presence of high purity gaseous oxygen and hexane
- Excellent oxidation resistance
- Good corrosion resistance
- Excellent water and steam resistance

Typical applications:

- Bakery equipment (ovens)
- Kiln truck wheels
- Load rollers in copying machines
- Wafer baking machines
- Textile dryers
- Film stretching tenders
- Electric motors running at extreme temperatures
- Emergency / hot fans
- Vacuum pumps



Important note:

LGET 2 is a fluorinated grease and is not compatible with other greases, oils and preservatives. Therefore, very thorough cleaning of bearings and systems is essential before applying fresh grease (except when reapplying LGET 2).

Technical data

Designation LGET 2/(pack size)

DIN 51825 code	KFK2U-40
NLGI consistency class	2
Soap type	PTFE
Colour	Off white
Base oil type	Synthetic (fluorinated polyether)
Operating temperature range	-40 to +260 °C (-40 to +500 °F)
Dropping point DIN ISO 2176	>300 °C (>570 °F)
Base oil viscosity	
40 °C, mm ² /s	400
100 °C, mm ² /s	38
Penetration DIN ISO 2137	
60 strokes, 10 ⁻¹ mm	265–295
Mechanical stability	
Roll stability, 50 hrs at 80 °C, 10 ⁻¹ mm	±30 max. 130 °C (265 °F)

Corrosion protection	
Emcor: – standard ISO 11007	1–1
Water resistance	
DIN 51 807/1, 3 hrs at 90 °C	0 max.
Oil separation	
DIN 51 817, 7 days at 40 °C, static, %	13 max. 30 hrs at 200 °C (390 °F)
Copper corrosion	
DIN 51 811, 110 °C	1
Rolling bearing grease life	
ROF test	>700, 5 600 r/min.*
L ₅₀ life at 10 000 r/min., hrs	at 220 °C (430 °F)
EP performance	
4–ball test, welding load DIN 51350/4, N	8 000 min.
Available pack sizes	50 g (25 ml) syringe 1 kg

* Typical value

SKF Food Grade Lubricants

LGFP 2

General purpose food grade grease

SKF LGFP 2 is a clean, non-toxic bearing grease, which is based on medical white oil using an aluminium complex soap.

- High resistance to water
- Excellent grease life
- Excellent corrosion resistance
- An essentially neutral pH value
- NSF H1 registered and Halal and Kosher certified

Applications

- Multi-pack cassette bearings
- Wrapping machines
- Conveyor bearings
- Bottling machines



Ordering details

Pack sizes	LGFP 2
420 ml cartridge	LGFP 2/0.4
1 kg can	LGFP 2/1
18 kg can	LGFP 2/18
180 kg can	LGFP 2/180
SKF SYSTEM 24 / LAGD 60 ml	LAGD 60/FP2

Pack sizes	LGFP 2
SKF SYSTEM 24 / LAGD 125 ml	LAGD 125/FP2
SKF SYSTEM 24 / TLSD 125 ml	TLSD 125/FP2
SKF SYSTEM 24 / TLSD 250 ml	TLSD 250/FP2
TLMR 120 ml	LGFP 2/MR120
TLMR 380 ml	LGFP 2/MR380

Technical data

Designation	LGFP 2/(pack size)
NLGI consistency class	2
DIN 51825 code	K2G-20
Appearance	Transparent
Soap type	Aluminium complex
Base oil type	Medical white oil
Operating temperature range	-20 to +110 °C (-5 to +230 °F)
Dropping point DIN ISO 2176	>250 °C (>480 °F)
Base oil viscosity	
40 °C, mm ² /s	130
100 °C, mm ² /s	7,3
Penetration DIN ISO 2137	
60 strokes, 10 ⁻¹ mm	265-295
100 000 strokes, 10 ⁻¹ mm	+30 max.

Corrosion protection	
Emcor: - standard ISO 11007	0-0
Water resistance	
DIN 51 807/1, 3 hrs at 90 °C	1 max.
Oil separation	
DIN 51 817, 7 days at 40 °C, static, %	1-5
Rolling bearing grease life	
ROF test	
L ₅₀ life at 10 000 r/min., hrs	1 000 at 110 °C (230 °F)
EP performance	
4-ball test, welding load DIN 51350/4, N	1 100 min.
Shelf life	2 years
NSF Reg. No.	128004

LGFS 00

General purpose food grade grease

SKF LGFS 00 is a premium synthetic base oil and Aluminium complex thickened grease suitable for applications where vegetarian and nut-free food is produced.

- LGFS 00 does not contain any natural products derived from animals, GMO's and nuts
- It does not promote the growth of bacteria and fungal organisms
- NSF H1 registered and Halal and Kosher certified

Applications

Enclosed industrial gearboxes and automatic, centralized lubrication systems such as those used for:

- Packaging
- Cutting/forming knives
- Conveyers

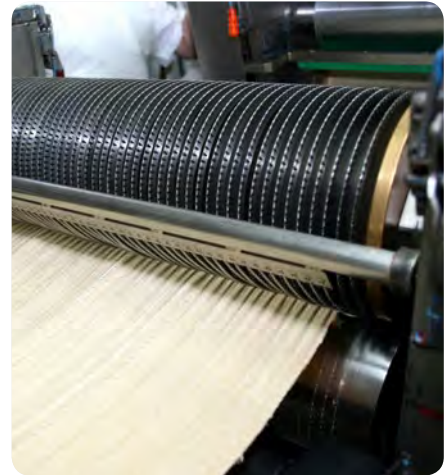

Ordering details

Pack sizes	LGFS 00
19 kg can	LGFS 00/19

Technical data

Designation	LGFS 00/(pack size)
NLGI number, DIN 51818	00
Classification, DIN 51502	GP HC 00 G-40
Classification, ISO 6743-9	L-XEBEB 00
Appearance	White semi-fluid
Type of thickener	Aluminium complex
Base oil type	Synthetic (PAO)
Operating temperatures range	-45 to +100 °C (-49 to +212 °F) peak up to 120 °C (248 °F)

Dropping Point ISO 2176	>200 °C (>392 °F)
Penetration ISO 2137 25 °C, 10 ⁻¹ mm	400-430
Base oil viscosity ISO 3104 40 °C, mm ² /s	220
100 °C, mm ² /s	25
Shelf life	2 years
NSF Reg. No.	149602

LGFD 2

High load food grade grease

SKF LGFD 2 is a premium synthetic base oil and Aluminium complex thickened grease suitable for applications experiencing high loads.

- Excellent oxidation and mechanical stability
- Excellent water and corrosion resistance
- Excellent adhesive properties
- NSF H1 registered and Halal and Kosher certified

Applications

Lubrication of bearings, joints, linkages and slides in F&B industry, for the machines used in:

- Packaging
- Bottling
- Wrapping
- Conveyers

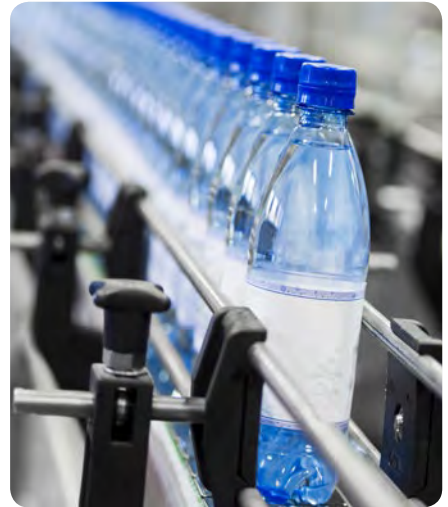

Ordering details

Pack sizes	LGFD 2
400 ml cartridge	LGFD 2/0.4
19 kg can	LGFD 2/19

Technical data

Designation	LGFD 2/(pack size)
NLGI number, DIN 51818	2
Classification, DIN 51502	KP HC 2 K-30
Classification, ISO 6743-9	L-XCCEB 2
Appearance	White smooth paste
Type of thickener	Aluminium complex
Base oil type	Synthetic (PAO)
Operating temperatures range	-35 to +120 °C (-31 to +248 °F) peak up to 140 °C (284 °F)

Dropping Point ISO 2176	>240 °C (>464 °F)
Penetration ISO 2137 25 °C, 10 ⁻¹ mm	265-295
Base oil viscosity ISO 3104 40 °C, mm ² /s	220
100 °C, mm ² /s	25
Shelf life	2 years
NSF Reg. No.	149601

LGFC 1

Low temperature food grade grease

SKF LGFC 1 is a premium synthetic base oil and Aluminium complex thickened grease suitable for applications experiencing low temperatures.

- Excellent low temperature performance
- Excellent water and corrosion resistance
- Excellent adhesive properties
- NSF H1 registered and Halal and Kosher certified

Applications

Lubrication of bearings, joints, linkages and slides in F&B industry, for machines used in:

- Freezers
- Cooling processes

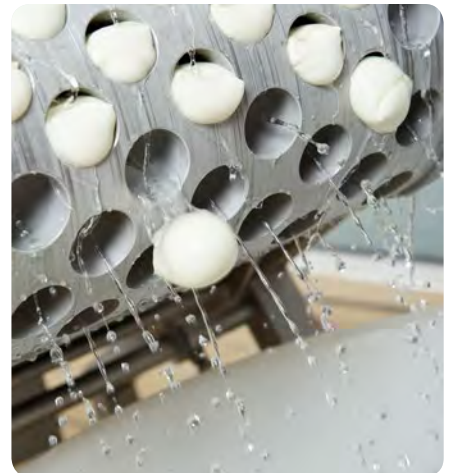

Ordering details

Pack sizes	LGFC 1
400 ml cartridge	LGFC 1/0.4
19 kg can	LGFC 1/19

Technical data

Designation	LGFC 1/(pack size)
NLGI number, DIN 51818	1
Classification, DIN 51502	KHC 1 E-50
Classification, ISO 6743-9	L-XEBEA 1
Appearance	Pale yellow, smooth paste
Type of thickener	Aluminium complex
Base oil type	Synthetic (PAO)
Operating temperatures range	-50 to +100 °C (-58 to +212 °F) peak up to 110 °C (230 °F)
Dropping Point ISO 2176	>200 °C (>392 °F)

Penetration ISO 2137 25 °C, 10 ⁻¹ mm	310-340
Base oil viscosity ISO 3104 -30 °C, mm ² /s	960
+40 °C, mm ² /s	20
+100 °C, mm ² /s (calculated)	4.8
Flow pressure -25 °C, mbar	300
-35 °C, mbar	475
Shelf life	2 years
NSF Reg. No.	149603

LGFT 2

High temperature food grade grease

SKF LGFT 2 is a premium synthetic base oil and inorganically thickened¹ grease suitable for applications experiencing high temperatures.

- Excellent high temperature performance
- Excellent water and corrosion resistance
- Excellent adhesive properties
- NSF H1 registered and Halal and Kosher certified

Applications

Lubrication of bearings, joints, linkages and slides in F&B industry, for the machines used in:

- Ovens
- Other bakery equipment

¹ LGFT 2 is based on an inorganic thickener and should therefore not be mixed with most greases based on other type of thickeners.

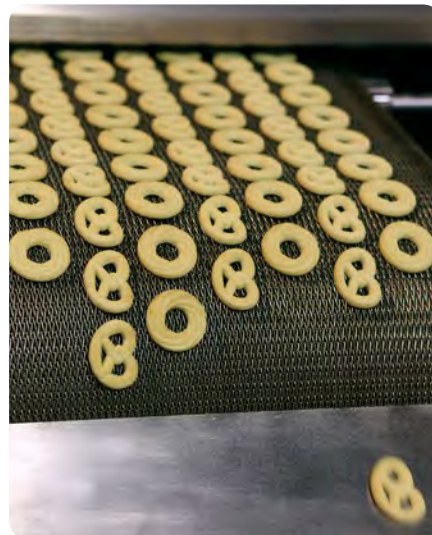

Ordering details

Pack sizes	LGFT 2
400 ml cartridge	LGFT 2/0.4
19 kg can	LGFT 2/19

Technical data

Designation	LGFT 2/(pack size)
NLGI number, DIN 51818	2
Classification, DIN 51502	KP HC 2 S-30
Classification, ISO 6743-9	L-XCGEA 2
Appearance	Beige, smooth paste
Type of thickener	Inorganic
Base oil type	Synthetic (PAO)
Operating temperatures range	-30 to +200 °C (-22 to +392 °F) peak up to 220 °C (428 °F)

Dropping Point ISO 2176	None
Penetration ISO 2137 25 °C, 10 ⁻¹ mm	265-295
Base oil viscosity ISO 3104 40 °C, mm ² /s	400
100 °C, mm ² /s	40
200 °C, mm ² /s (calculated)	6
Shelf life	2 years
NSF Reg. No.	149604

LFFH 46

Food grade hydraulic oil

LFFH 68

SKF LFFH 46 and LFFH 68 are synthetic hydraulic fluids suitable for lubrication of machinery used in the food industry.

- Excellent anti-wear performance
- Excellent water separation properties
- Excellent protection against corrosion
- NSF H1 registered and Halal and Kosher certified

Applications

- Hydraulic systems
- Hydrostatic gears
- Circulating oil systems



Ordering details

Pack sizes	LFFH 46	LFFH 68
22 l can	LFFH 46/22	LFFH 68/22
205 l can	LFFH 46/205	LFFH 68/205

Technical data

Designation	LFFH 46/(pack size)	LFFH 68/(pack size)
Appearance	Yellowish	Yellowish
Base oil type	Synthetic	Synthetic
Base oil viscosity ISO 3104		
40 °C, mm ² /s	46	68
100 °C, mm ² /s	7.9	10.9
Density ISO 12185		
15 °C, kg/m ³	836	843
Flash point DIN/EN/ISO 2592 COC	248 °C	258 °C
Pourpoint ISO 3016	<-60 °C	<-60 °C
FZG-Test A/8.3/90 Failure Load Stage DIN 51354-2	12	>12
Viscosity Index DIN ISO 2909	142	143
Shelf life	2 years	2 years
NSF Reg. No.	149599	149600

LFFG 220

Food grade gear oil

LFFG 320

SKF LFFG 220 and LFFG 320 are synthetic gear oils suitable for lubrication of machinery used in the food industry.

- Excellent EP properties
- High viscosity index resulting in minimum variation of viscosity with change of temperature
- Excellent protection against corrosion
- NSF H1 registered and Halal and Kosher certified

Applications

- Enclosed gear boxes
- Packaging
- Conveyers

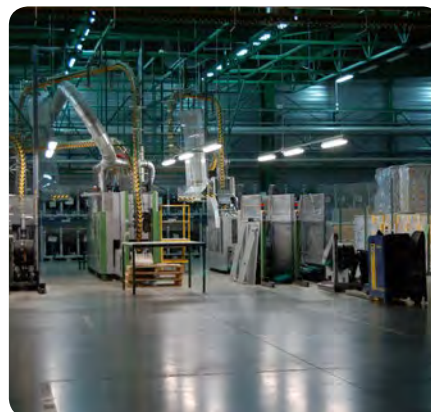

Ordering details

Pack sizes	LFFG 220	LFFG 320
22 l can	LFFG 220/22	LFFG 320/22
205 l can	LFFG 220/205	LFFG 320/205

Technical data

Designation	LFFG 220/(pack size)	LFFG 320/(pack size)
Appearance	Pale yellow	Pale yellow
Base oil type	Synthetic	Synthetic
Base oil viscosity ISO 3104		
40 °C, mm ² /s	220	320
100 °C, mm ² /s	25	33.4
Density ISO 12185		
15 °C, kg/m ³	847	852
Flash point DIN/EN/ISO 2592 COC	276 °C	278 °C
Pourpoint ISO 3016	-48 °C	-45 °C
FZG-Test A/8.3/90 Failure Load Stage DIN 51354-2	>12	>12
Viscosity Index DIN ISO 2909	143	147
Shelf life	2 years	2 years
NSF Reg. No.	149597	149598

LFFM 80

Food grade chain oil

LHFP 150

Our food grade chain oil range is specifically developed for food and beverage applications where high temperature, high humidity and low temperatures are critical factors to consider in the selection of the correct oil.

LFFT 220

LFFM 80 - High moisture chain oil LFFM 80 exhibits particularly good performance in high moisture environments such as in proofers and pasta driers as well as in applications where condensation might occur. This low viscosity semi-synthetic base oil prevents residue build-up on the chains and offers good wear and corrosion protection.

LHFP 150 - General purpose chain oil LHFP 150 excels in low to elevated temperature applications such as in confectionery industries and fruit and vegetable processing. The formulation is based on a synthetic oil and the product provides good corrosion and wear protection together with good aging and oxidation stability.

LFFT 220 - High temperature performance chain oil LFFT 220 is mainly for use in bakery ovens or other equipment subjected to high temperatures. It provides good wear protection and low evaporation losses at elevated temperatures along with excellent oxidation resistance due to its formulation and synthetic base.



Ordering details

Pack sizes	LFFM 80	LHFP 150	LFFT 220
5 l can	LFFM 80/5	LHFP 150/5	LFFT 220/5
SKF SYSTEM 24 / LAGD 125 ml	LAGD 125/FFM80	LAGD 125/HFP15	LAGD 125/FFT22

Technical data

Designation	LFFM 80	LHFP 150	LFFT 220
Appearance	White	Colourless	Yellow
Base oil type	Semi synthetic (mineral/ester)	Synthetic ester	Synthetic ester
Specific gravity	0.89	0.85	0.95
Operating temperature range	-30 to +120 °C (-22 to +248 °F)	-30 to +120 °C (-22 to +248 °F)	0 to 250 °C (32 to 482 °F)
Base oil viscosity: 40 °C, mm ² /s 100 °C, mm ² /s	approx. 80 approx. 10	ISO VG 150 approx. 19	ISO VG 220 approx. 17
Flash point	>200 °C (>392 °F)	>200 °C (>392 °F)	>250 °C (>482 °F)
NSF Reg. No.	146767	136858	146768

LDTS 1

Food grade dry film lubricant

SKF Dry Film Lubricant LDTS 1 has been specially developed for automatic lubrication of plastic flat top chain conveyors in the beverage processing industry. It adheres very well to all treated surfaces and has outstanding properties. The lubricant consists of synthetic oil and is doped with PTFE solid lubricant.

- Cost savings by eliminating high volume of water and soluble lubricant.
- Improved operator safety by reducing slip hazards.
- Quality of packaging is maintained by elimination of moisture.
- Reduced risk of product contamination by minimising microbiological growth.
- Enhanced line efficiency by avoiding replacement costs and associated unplanned production stops.
- Reduced cleaning costs.

Applications

- Conveyors in bottling lines using PET, carton, glass or can packages.



Ordering details

Pack sizes

5 l can

LDTS 1

LDTS 1/5

Technical data

Designation	LDTS 1
Composition	Mineral oils, hydrocarbons, additives, PTFE
Appearance	White
Operating temperature range	-5 to +60 °C (25 to 140 °F)
Viscosity at 40 °C (104 °F)	ca. 28 mm ² /s
Pour point	<0 °C
Density 25 °C (77 °F)	ca. 841 kg/m ³

Flash point of the preparation	ca. 100 °C (210 °F)
Flash point after evaporation of the solvent	>170 °C (340 °F)
NSF Reg. No.	139739

Special lubricants

LESA 2

SKF Energy Efficient (E2) bearing greases

LEGE 2

Spherical roller bearings - SKF LESA 2 grease combines a fully synthetic polyalphaolefine (PAO) base oil with a unique lithium soap thickener. This premium quality, low friction grease has been specially developed for SKF Energy Efficient spherical roller bearings.

All ball bearings - SKF LEGE 2 grease combines a fully synthetic ester oil with a unique lithium soap thickener. This premium quality, low friction grease has been specially developed for SKF Energy efficient ball bearings.



- Low friction torque.
- Low level of power loss.
- Quiet running behavior.
- Extremely good oxidation stability.
- Wide temperature range.



Technical data

Designation	LESA 2/(pack size)	LEGE 2/(pack size)
DIN 51825 code	KP2G-50	K2N-50
NLGI consistency class	2	2-3
Soap type	Lithium	Lithium
Colour	Beige	Light brown
Base oil type	PAO	Ester
Operating temperature range	-50 to +110 °C (-60 to +230 °F)	-50 to +150 °C (-58 to +302 °F)
Dropping point DIN ISO 2176	180 min. (356 min.)	> 185 °C (365 °F)
Base oil viscosity		
40 °C, mm ² /s	18	25
100 °C, mm ² /s	4,5	4,9
Penetration DIN ISO 2137		
60 strokes, 10 ⁻¹ mm	265-295	240-270
100 000 strokes, 10 ⁻¹ mm	+50 max. (325 max.)	330 max.
Mechanical stability		
Roll stability, 50 hrs at 80 °C, 10 ⁻¹ mm	380 max.	310
Corrosion protection		
SKF Emcor standard ISO 11007	0-1	0-0
SKF Emcor 0,5% salt water	-	0-0
Water resistance		
DIN 51 807/1, 3 hrs at 90 °C	1 max.	0
Oil separation		
DIN 51 817, 7 days at 40 °C, static, %	<4	-
Copper corrosion		
DIN 51 811 at 110 °C	1 max. 100 °C (210 °F)	-
ISO 2160 at 140 °C	-	1b
Rolling bearing grease life		
ROF test, L ₅₀ life at 10 000 r/min, hrs	-	>1 000 at 150 °C (302 °F)
ROF test, L ₅₀ life at 20 000 r/min, hrs	>1 000 at 110 °C (230 °F)	-
EP performance		
4-ball test, welding load DIN 51350/4, N	2 000 min.	-
Available pack sizes	420 ml cartridge, 1, 5, 18 kg can	420 ml cartridge, 1 kg can

LMCG 1

Grid and gear coupling grease

LMCG 1 is a polyethylene thickened and mineral oil based grease which also uses a lithium complex thickening technology. The grease is formulated to withstand high centrifugal forces and high-torque applications for grid and gear (flexible) couplings even where severe shock loadings, misalignment and vibration occur.

- Excellent resistance to oil separation
- High acceleration and high operating speeds
- Excellent high-torque lubrication
- High corrosion protection
- Exceeds AGMA Type CG-1 and AGMA Type CG-2 requirements



Applications

- Grid and gear couplings
- Flexible heavy duty grid and gear coupling

LGLS 0

Low temperature chassis grease

SKF LGLS 0 is a semi-fluid chassis grease that has been developed to be used via lubrication systems under low to medium temperatures. Its anhydrous calcium thickener, combined with a high base oil viscosity, offers excellent water resistance and stickiness to surfaces as well as very good anti-wear properties.

- Excellent pumpability at low to medium temperatures.
- Excellent water resistance and corrosion protection.
- Excellent anti-wear properties.
- Excellent adhesion to surfaces.



Technical data

Designation	LMCG 1/(pack size)	LGLS 0/(pack size)
DIN 51825 code	G0G1G-0	KP0G-40
NLGI consistency class	1	0
Soap type	Polyethylene	Anhydrous calcium
Colour	Brown	Red
Base oil type	Mineral	Mineral oil & polymers
Operating temperature range	0 to 120 °C (32 to 248 °F)	-40 to +100 °C (-40 to +212 °F)
Dropping point DIN ISO 2176	210 °C (410 °F)	>120 °C (>248 °F)
Base oil viscosity		
40 °C, mm ² /s	670	1 370
100 °C, mm ² /s	34	96
Penetration DIN ISO 2137		
60 strokes, 10 ⁻¹ mm	310-340	355-385
Corrosion protection		
SKF Emcor standard ISO 11007	0-0	0-0
Salt water test (100% seawater)	2-2	-
Water wash-out test, ISO 11009	-	<10%
Flow pressure at -40 °C	-	<1 400 mbar
EP performance		
Wear scar DIN 51350/5, 1 400 N, mm	0,5 max.	-
4-ball test, welding load DIN 51350/4	3 200 N*	3 200 N
Available pack sizes	35 g tube, 420 ml cartridge, 2, 18, 50 kg can	18 kg can

* Typical value

LHMT 68

SKF Chain Oil

LHHT 265

Designed to fulfill the requirements of most industrial chain applications

LHMT 68 - SKF LHMT 68 is ideal for medium temperatures and dusty environments like those of cement and material handling industries, where a high penetration and light film are required.

LHHT 265 - SKF LHHT 265 synthetic oil is ideal for high load and/or high temperature conditions, like those found in the pulp and paper and textile industries. It doesn't form any residue at high temperatures and it is neutral towards seals and polymers.

- Increase chain life and re-lubrication interval
- Reduce oil consumption and energy consumption

Applications

- Conveyor chains
- Drive chains
- Lift chains



Ordering details

Chain oil	LHMT 68	LHHT 265
Description	Medium temperature oil	High temperature oil
Can 5 liter	LHMT 68/5	LHHT 265/5

SKF SYSTEM 24

LAGD series	Unit 60 ml Unit 125 ml	LAGD 60/HMT68* LAGD 125/HMT68*	- LAGD 125/HHT26*
TLSD series	Complete unit 122 ml Complete unit 250 ml Refill set 122 ml Refill set 250 ml	TLSD 125/HMT68 TLSD 250/HMT68 LHMT 68/EML125 LHMT 68/EML250	TLSD 125/HHT26 TLSD 250/HHT26 LHHT 265/EML12 LHHT 265/EML25

* Includes non-return valve

Technical data

Designation	LHMT 68	LHHT 265
Description	Medium temperature oil	High temperature oil
Specific gravity	0.85	0.92
Colour	Yellowish brown	Yellow orange
Base oil type	Mineral	Synthetic ester
Operating temperature range	-15 to +90 °C (5 to 194 °F)	Up to 250 °C (482 °F)
Base oil viscosity: 40 °C, mm ² /s 100 °C, mm ² /s	ISO VG 68 approx. 9	approx. 265 approx. 30
Flash point	>200 °C (392 °F)	approx. 260 °C (500 °F)
Pour point	<-15 °C (5 °F)	n/a

Technical data

Understanding grease technical data

Some basic knowledge is required to understand the technical data so that you can select the proper grease. This is an excerpt of the main terms mentioned in SKF grease technical data.

Consistency

A measure of the stiffness of a grease. A proper consistency must ensure that the grease stays in the bearing without generating too much friction. It is classified according to a scale developed by the NLGI (National Lubricating Grease Institute). The softer the grease, the lower the number. Grease for bearings are typically NLGI 1, 2 or 3. The test measures how deep a cone falls into a grease sample in tenths of mm.

Classification of greases by NLGI consistency number

NLGI number	ASTM worked penetration (10 ⁻¹ mm)	Appearance at room temperature
000	445–475	very fluid
00	400–430	fluid
0	355–385	semi-fluid
1	310–340	very soft
2	265–295	soft
3	220–250	medium hard
4	175–205	hard
5	130–160	very hard
6	85–115	extremely hard

Temperature range

Comprehends the suitable working range of the grease. It goes between the low temperature limit (LTL) and the high temperature performance limit (HTPL). LTL is defined as the lowest temperature at which the grease will allow the bearing to be started up without difficulty. Below this limit, starvation will occur and cause a failure. Above HTPL, the grease will degrade in an uncontrolled way so that grease life cannot be determined accurately.

Dropping point

Temperature at which a grease sample, when heated, will begin to flow through an opening according to DIN ISO 2176. It is important to understand that this point is considered to have limited significance for performance of the grease as it is always far above HTPL.

Viscosity

A measure of a fluid's resistance to flow. For lubricants, a proper viscosity must guarantee an adequate separation between surfaces without causing too much friction. According to ISO standards, it is measured at 40 °C (105 °F), as viscosity changes with temperature. Values at 100 °C (210 °F) allow calculation of the viscosity index, e.g. how much the viscosity will decrease when temperature rises.

Mechanical stability

The consistency of bearing greases should not significantly change during its working life. Three main tests are normally used to analyse this behaviour:

- **Prolonged penetration**

The grease sample is subjected to 100 000 strokes in a device called a grease worker. Then, the penetration is measured. The difference against penetration at 60 strokes is reported as the change in 10⁻¹ mm.

- **Roll stability**

A grease sample is placed in a cylinder with a roller inside. The cylinder is then rotated for 72 or 100 hours at 80 or 100 °C (175 or 210 °F) (the standard test demands just 2 hours at room temperature). At the end of the test period, once the cylinder has cooled to room temperature, the penetration of the grease is measured and the change in consistency is reported in 10⁻¹ mm.

- **V2F test**

A railway axlebox is subjected to vibration shocks of 1 Hz from a bouncing hammer producing an acceleration level between 12–15 g. After 72 hours at 500 r/min., the grease leaked from the housing through the labyrinth seal is collected in a tray. If it weighs less than 50 g, a rating of 'm' is granted, otherwise it is rated as 'fail'. Afterwards, the test is continued for another 72 hours at 1 000 r/min. If less than 150 grams of grease leaked after completion of both tests, then a rating of 'M' is given.



Roll stability test rig



V2F grease test rig



Emcor grease test rig

Corrosion protection

Corrosive environments demand special properties for rolling bearing greases. During the Emcor test, bearings are lubricated with a mixture of grease and distilled water. At the end of the test, a value between 0 (no corrosion) and 5 (very severe corrosion) is given. Salt water, instead of distilled water or continuous water flow (washout test), can be used to make the test more severe.

Water resistance

A glass strip is coated with the candidate grease, which is placed into a water-filled test tube. The test tube is immersed in a water bath for three hours at a specified test temperature. The change in the grease is visually evaluated and reported as a value between 0 (no change) and 3 (major change) along with the test temperature.

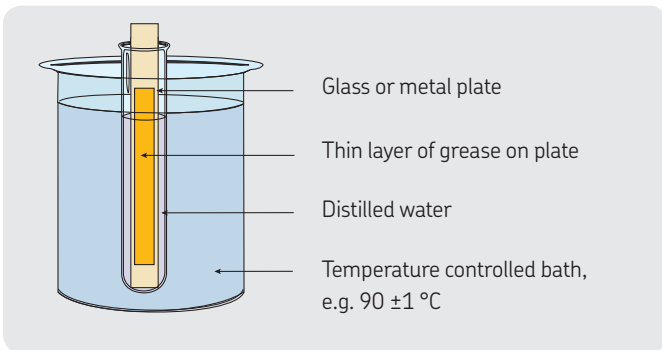

Water resistance test

Oil separation

Lubricating greases release oil when stored for long periods of time or when used in bearings as a function of temperature. The degree of oil separation will depend upon the thickener, base oil and manufacturing method. In the test, a cup is filled with a given quantity of grease (and is weighed before the test) and a 100 gram weight is placed on top of the grease. The complete unit is placed into an oven at 40 °C (105 °F) for one week. At the end of the week, the amount of oil which has leaked through the sieve, is weighed and reported as a percentage of weight loss.

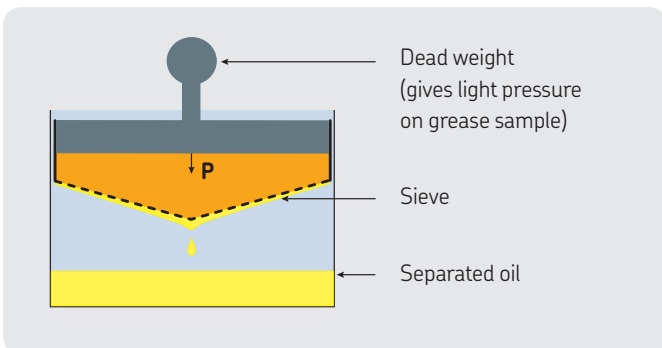

Oil separation test

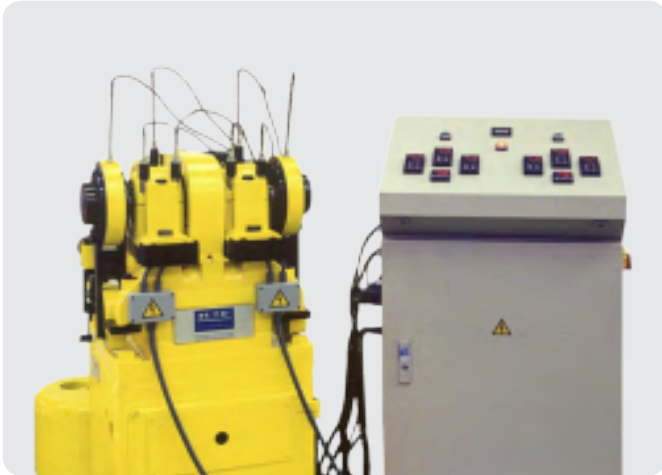

R2F grease test rig

Lubrication ability

The R2F test assesses the high temperature performance and lubricating ability of a grease. A shaft with two spherical roller bearings in their respective housings is driven by an electric motor. The bearings are run under load, the speed may be varied and heat can be applied. The test method is carried out under two different conditions after which the wear of the rollers and the cage is measured. Test A is conducted at ambient temperature and a “pass” rating means that the grease can be used to lubricate large bearings at normal operating temperatures and also in low vibrating applications. Test B runs at 120 °C (250 °F) and a “pass” rating indicates suitability for large bearings at high temperatures.

Copper corrosion

Lubricating greases should protect copper alloys used in bearings from corrosive attack while in service. To assess these properties, a copper strip is immersed in the grease sample and placed in an oven. The strip is then cleaned and the degradation is observed. The result is rated by a numerical system and a rating above 2 indicates poor protection.

Rolling bearing grease life

The ROF and ROF+ tests determine the grease life and its high temperature performance limit (HTPL). Ten deep groove ball bearings are fitted into five housings and filled with a given quantity of grease. The test is undertaken at a pre-determined speed and temperature. Axial and radial loads are applied and the bearings run to failure. The time to failure is recorded in hours and a Weibull life calculation is made to establish the grease life. This information can then be used to determine re-lubrication intervals in an application.



ROF+ grease test rig

Extreme pressure (EP) performance

The 4-ball weld load test rig uses three steel balls held in a cup. A fourth ball is rotated against the three balls at a given speed. A starting load is applied and increased at pre-determined intervals until the rotating ball seizes and welds to the stationary balls. Values above 2 600 N are typically expected in EP grease. Under the 4-ball wear scar test, SKF applies 1 400 N (standard test uses 400 N) on the fourth ball during 1 minute. The wear on the three balls is measured and values below 2 mm are considered as appropriate values for EP greases.

Fretting corrosion

Vibrating or oscillating conditions are typical causes for fretting corrosion. Under the FAFNIR test, two thrust ball bearings are loaded and subjected to oscillation. The wear on each bearing is then measured. A wear below 7 mg indicates good fretting protection.

Thickener compatibility chart

	Lithium	Calcium	Sodium	Lithium complex	Calcium complex	Sodium complex	Barium complex	Aluminium complex	Clay (Bentonite)	Common polyurea*	Calcium sulphonate complex
Lithium	+	●	-	+	-	●	●	-	●	●	+
Calcium	●	+	●	+	-	●	●	-	●	●	+
Sodium	-	●	+	●	●	+	+	-	●	●	-
Lithium complex	+	+	●	+	+	●	●	+	-	-	+
Calcium complex	-	-	●	+	+	●	-	●	●	+	+
Sodium complex	●	●	+	●	●	+	+	-	-	●	●
Barium complex	●	●	+	●	-	+	+	+	●	●	●
Aluminium complex	-	-	-	+	●	-	+	+	-	●	-
Clay (Bentonite)	●	●	●	-	●	-	●	-	+	●	-
Common polyurea*	●	●	●	-	+	●	●	●	●	+	+
Calcium sulphonate complex	+	+	-	+	+	●	●	-	-	+	+

+ = Compatible
 ● = Test required
 - = Incompatible

* SKF high performance, high temperature bearing grease LGHP 2 is not a common polyurea type grease. It is a di-urea bearing grease, which has successfully been tested for compatibility with lithium and lithium complex thickened greases i.e. LGHP 2 is compatible with such greases.

Base oil compatibility chart

	Mineral/PAO	Ester	Polyglycol	Silicone: Methyl	Silicone: Phenyl	Polyphenylether	PFPE
Mineral/PAO	+	+	-	-	+	●	-
Ester	+	+	+	-	+	●	-
Polyglycol	-	+	+	-	-	-	-
Silicone: methyl	-	-	-	+	+	-	-
Silicone: phenyl	+	+	-	+	+	+	-
Polyphenyl-ether	●	●	-	-	+	+	-
PFPE	-	-	-	-	-	-	+

+ = Compatible ● = Test required - = Incompatible

Storage tools

Modernise your oil storage and handling practices

Oil storage station

Oil storage station is an integrated solution designed to minimize the chances for lubricating oils to get cross contaminated or contaminated during storage and transfer. It is a customized solution helping to help ensure clean, organized, safe and reliable lubricant identification, storage and transfer. It consists of the tailor-made set of colour-coded tanks, pumps, hose reels, filters and additional lubricant handling equipment and tools.

Features

- Choice of four aluminized steel tank sizes: 113, 246, 454 and 908 litre (30, 65, 120 and 240 US gal)
- Scalable and configurable – scale system to accommodate the number of lubricants required for storage and dispensing
- Choice of 10 tank colours
- Spill control – all systems come standard with integrated spill pans for SPCC compliance and overall environmental protection
- Fire suppression – includes MSHA-CFR30 – rated flame resistant fire suppression hoses as standard with optional fusible link tank isolation valves and auto-shut off taps
- Filtration – all systems come with fluid filtration capability with a choice of micron ratings and also desiccant air breathers
- Accommodates lubricants up to ISO VG 680
- All systems ship in fully assembled pods – for efficient freight and rapid on-site installation
- Transport – all systems have integrated spill transport pallets for easy forklift and hand truck access for freight and workplace mobility
- Power – all systems come standard with 110V single phase TEFC motors and can be configured for other power supplies as required



Standard model

- Best practice contamination control
- Very space efficient
- Easy relocation around the plant
- One pump and filter per tank
- Pressurized dispensing



Superior model

- Excellent contamination control
- Instant lube room
- Premium ergonomic dispensing and working surfaces
- Integrated parts and tool storage
- Electrical and mechanical protection systems
- One pump and filter per tank
- Pressurized dispensing
- Numerous upgrade options



Optimum cleanliness when filling your grease guns

SKF Grease Filler Pumps LAGF series

Best lubrication practices say that each type of grease requires an individual grease gun and the refilling has to be a clean process. SKF Grease Filler Pumps are designed to help achieve this goal.

- Quick filling: low pressure high stroke volume
- Easy installation: all necessary items are included
- Reliable: tested and approved for all SKF greases
- Appropriate as a complement for SKF Bearing Packer VKN 550

Technical data

Designation	LAGF 18	LAGF 50
Maximum pressure	30 bar (430 psi)	30 bar (430 psi)
Volume/stroke	approx. 45 cm ³ (1.5 US fl. oz)	approx. 45 cm ³ (1.5 US fl. oz)
Suitable drum dimensions: inside diameter maximum inside height	265–285 mm (10.4–11.2 in.) 420 mm (16.5 in.)	350–385 mm (13.8–15.2 in.) 675 mm (26.6 in.)
Weight	5 kg (11 lb)	7 kg (15 lb)

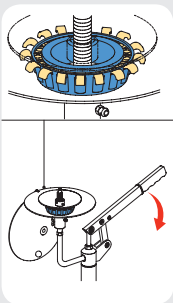

Contamination free grease filling

SKF Bearing Packer VKN 550

The sturdy and easy-to-use SKF Bearing Packer VKN 550 is designed to completely fill open bearings such as tapered roller bearings. They can be used with a standard grease gun, air-operated grease pump or grease filler pump.

- Flushes the grease right between the rolling elements
- Closed system: the cover lid prevents ingress of dirt

Note: Most suitable in conjunction with SKF Grease Filler Pumps LAGF Series



Technical data

Designation	VKN 550
Bearing range: inner diameter (d)	19 to 120 mm (0.7 to 4.7 in.)
outer diameter (D)	max. 200 mm (7.9 in.)

Transfer tools



TLRC



TLRS

A smarter way to handle your hoses

Hose reels TLRC & TLRS series

Hoses are required anywhere flexible ways of conveying fluids are required. However, their flexible nature make them difficult to keep tidy and untangled. Hose reels are designed to help solve that problem.

Features

- High quality materials consistent with application demands. From lightweight (composite) versions for medium duty applications (TLRC series) to very robust for the most demanding applications (TLRS series)
- A thorough cleaning process prior to an individual coating process, along with a long life swivel design help to maximise service life
- The declutching shaft and the enclosed drive mechanism prevent reverse winding and protect the system against the environment
- Unlike many hose reels on the market, the TLRS series has a strong welded pedestal. This construction is designed and built for heavy duty applications

Benefits

- Reduce the risk of accidents due to tripping or from vehicles running over exposed hoses
- Increase lifetime of hoses
- Minimise leakages
- Promote tidiness and cleanliness
- Save time when using hoses

Applications

- Lubricants storage rooms
- Assembly stations and factories in general
- Pneumatic tools
- Automotive service centres and tire stores
- Fire brigades and Service trucks
- Maintenance and administrative buildings

Technical data

Designation	Pressure		Max. temp.		Hose I.D.		Hose length		M(G) Outlet	F(G) Inlet	Hose colour	Application
	bar	psi	°C	°F	mm	in.	m	ft	in.	in.		
TLRC 15AW	21	300	65	150	10	3/8	15	50	1/4	1/2	Red	Low pressure air/water
TLRC 15AW/W	21	300	65	150	13	1/2	15	50	1/2	1/2	Red	Low pressure air/water
TLRS 15AW	21	300	65	150	10	3/8	15	50	1/4	1/2	Red	Low pressure air/water
TLRS 22AW	21	300	65	150	10	3/8	22	72	1/4	1/2	Red	Low pressure air/water
TLRS 15AW/W	21	300	65	150	13	1/2	15	50	3/8	1/2	Red	Low pressure air/water
TLRS 15H	138	2 000	99	210	13	1/2	15	50	1/2	1/2	Black	Medium pressure oil
TLRS 8G	400	5 800	99	210	6	1/4	8	25	1/4	1/4	Black	High pressure grease

Manual grease dispensing tools



A basic element of lubrication plans





The main pitfall of manual lubrication is ensuring accuracy and top cleanliness. Lubricant film in the application can be over 40 times thinner than the smallest visible particle. The SKF range of manual lubrication tools is designed to help you with the storage, handling, dosing and supplying of lubricants for your machinery in a clean and easy way.

A comprehensive range to meet your needs

SKF Grease Guns

SKF Grease Guns are suitable for agricultural, industrial, automotive and construction industries amongst others. Except for the SKF LAGP 400, which is designed for emptying cartridges only, all of them are equipped with a grease filling fitting. This fitting enables the use of SKF Grease Filler Pumps to refill the guns with loose grease, thus keeping contaminants out of the grease.

Selection chart and technical data – SKF Grease Guns

						
Designation	LAGP 400	TLGH 1	1077600	1077600/SET	LAGH 400	LAGG 400B and LAGG 400B/US
Drive	Manual	Manual	Manual	Manual	Manual One hand	Battery LAGG 400B (230 V charger) LAGG 400B/US (110 V charger)
Maximum pressure		400 bar (5 800 psi)	400 bar (5 800 psi)	400 bar (5 800 psi)	300 bar (4 350 psi)	400 bar (5 800 psi) Min. burst pressure: 800 bar (11 600 psi)
Volume per stroke	20 cm ³ (1.2 in. ³)	Approx. 0,9 cm ³ (0.05 in. ³)	Approx. 1,5 cm ³ (0.09 in. ³)	Approx. 1,5 cm ³ (0.09 in. ³)	Approx. 0,8 cm ³ (0.05 in. ³)	Approx. 400 g (0.9 lb)/10 min
Weight	0,35 kg (12 oz)	1,5 kg (3.3 lb)	1,5 kg (3.3 lb)	Complete: 2,4 kg (5.3 lb)	1,2 kg (2.6 lb)	Grease gun including battery 3,1 kg (6,8 lb)
Reservoir	Suitable for the SKF grease cartridges.	Loose grease (ca. 500 cm ³) or grease cartridges.	Loose grease (ca. 500 cm ³) or grease cartridges.	Loose grease (ca. 500 cm ³) or grease cartridges.	Loose grease (ca. 500 cm ³) or grease cartridges.	Loose grease (ca. 500 cm ³) or grease cartridges.
Discharge pipe length	–	175 mm (6.9 in.)	175 mm (6.9 in.)	175 mm (6.9 in.)	300 mm (12 in.)	750 mm (29.5 in.)
Accessories	–	1077601	1077601	1077601	1077601	–
Notes	Three spout caps included		1077600 H: 300 mm (12 in.)	Set includes: Extension pipe, Snap-on high pressure hose, Snap-on extension pipe with cardan nozzle, Snap-on extension pipe for flat-head grease fittings (Ø16 mm), Female and pointed nozzle		Supplied with carrying strap. Operating temperature range: –15 to +50 °C (5 to 120 °F)

Note: 1077601: Flexible 500 mm (19.7 in.) long pressure hose with hydraulic gripping nozzle.



Accurate grease quantity measurement

SKF Grease Meter LAGM 1000E

The amount delivered per stroke by grease guns depends on many variables. It is generally difficult to supply an accurate quantity of grease when manually lubricating bearings. The right amount of grease, however, is critical for the bearings' service life, as over- or under-greasing can result in machine breakdown. Although a common practice is to weigh the grease per stroke, this procedure does not consider the backpressure, the ongoing wear inside the grease gun or any other variables.

The SKF Grease Meter LAGM 1000E accurately measures grease discharge in volume or weight in metric (cm³ or g) or US units (US fl. oz or oz), making conversion calculations unnecessary.

- Suitable for most NLGI 0-3 greases
- A rubber sleeve protects the electronics in case of impact and is also oil and grease resistant
- The backlit LCD displays large and clear-to-read digits
- Maximum pressure of 700 bar (10 000 psi)
- Small, compact and lightweight design
- Corrosion-free aluminium housing
- Fits with all SKF grease guns



Technical data

Designation	LAGM 1000E
Housing material	Aluminium, anodised
Weight	0,3 kg (0.66 lb)
IP rating	IP 67
Suitable greases	NLGI 0 to NLGI 3
Maximum operating pressure	700 bar (10 000 psi)
Maximum grease flow	1 000 cm ³ /min (34 US fl. oz/min)
Thread connections	M10x1
Display	Lit LCD (4 digits / 9 mm)
Accuracy	±3% from 0 to 300 bar ±5% from 300 to 700 bar
Selectable units	cm ³ , g, US fl. oz or oz
Display lamp auto switch off	15 seconds after last pulse
Battery type	1 × 1,5 V AA Alkaline
Unit auto switch off	Programmable



Renew or upgrade your equipment

SKF Grease Nozzles LAGS 8

The SKF Grease Nozzles LAGS 8 kit provides practical accessories for daily lubrication, such as connectors, couplings and nozzles that are most widely used in the industry.

Technical data

Designation	LAGS 8
Maximum working pressure	400 bar (5 800 psi)
Minimum burst pressure	800 bar (11 600 psi)
Carrying case dimensions	530 x 85 x 180 mm (20.9 x 3.4 x 7.0 in.)

Kit contents

Straight pipe 180 mm and nozzle (DIN 71412)	1x
Hose with nozzle (DIN 71412)	1x
Tube with nozzle for bottom head grease fittings (DIN 3404)	1x
Tube with nozzle for Flush type grease fittings and plastic transparent cover (DIN 3405)	1x
Grease fitting M10x1-G ¹ / ₈	1x
Grease fitting M10x1-1 ¹ / ₈ -27NPS	1x
Nozzle (DIN 71412)	2x

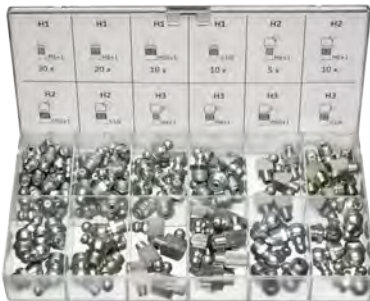

The link to your lubrication points

SKF Grease Nipples LAGN 120

The LAGN 120 grease fitting kit contains a full range of 120 standardised conical grease fittings made of precision steel, zinc plated, hardened and blue chromated.

Technical data

Designation	LAGN 120
Maximum working pressure	400 bar (5 800 psi)
Minimum burst pressure	800 bar (11 600 psi)

Kit contents

Grease fitting type	Quantity	Grease fitting type	Quantity
M6x1 straight	30x	M10x1 45°	5x
M8x1 straight	20x	G ¹ / ₈ 45°	5x
M10x1 straight	10x	M6x1 90°	5x
G ¹ / ₈ straight	10x	M8x1 90°	10x
M6x1 45°	5x	M10x1 90°	5x
M8x1 45°	10x	G ¹ / ₈ 90°	5x



Proper identification of your lubrication points

SKF Grease fitting caps and tags TLAC 50

In conjunction with the SKF Lubrication Planner software, grease fitting caps and tags offer a complete solution to protect lubrication fittings from external contamination and simultaneously allow for proper identification.



Technical data

Description	Value
Label dimensions	45 × 21 mm (1.8 × 0.8 in.)
Material	LLDP + 25% EVA
Temperature range	from -20 to +80 °C (-5 to +175 °F)
Suitable for grease fitting sizes	G ¹ / ₄ , G ¹ / ₈ , M6, M8, M10 and grease fitting head

Kits contents

Kit designation	Description
TLAC 50/B	50 blue caps and tags + 2 printable stickers sheets
TLAC 50/Y	50 yellow caps and tags + 2 printable stickers sheets
TLAC 50/R	50 red caps and tags + 2 printable stickers sheets
TLAC 50/G	50 green caps and tags + 2 printable stickers sheets
TLAC 50/Z	50 black caps and tags + 2 printable stickers sheets
TLAT 10	10 printable stickers sheets



Skin protection when handling grease

SKF Disposable Grease Resistant Gloves TMBA G11D

SKF TMBA G11D gloves are specially designed to protect skin when working with lubricants. The gloves are packed in a handy box containing 25 pairs.

- Non-powdered nitrile rubber gloves
- Tight fitting for precision wear
- Excellent resistance against lubricants
- Non-allergenic

Technical data

Designation	TMBA G11D
Pack size	25 pairs
Size	9
Colour	blue



For high volume requirements

SKF Grease Pumps LAGG series

SKF manual and air-operated grease pumps are designed to supply large amounts of grease. This is useful when large housings have to be filled or when numerous points have to be lubricated. They are also suitable for topping up centralised lubrication systems reservoirs.

- Full range: pumps available for 18, 50 or 180 kg (39, 110 or 400 lb) grease drums
- High pressure: maximum of 420 bar (6 090 psi) for air-driven models
- Reliable: tested and approved for SKF greases
- Easy and ready to install
- 3,5 m (11.5 ft) of tubing included



LAGG 18M

LAGG 18AE

LAGG 50AE

LAGG 180AE

LAGT 180

Technical data

Designation	LAGG 18M	LAGG 18AE	LAGG 50AE	LAGG 180AE	LAGT 180
Description	Grease pump for 18 kg (39.6 lb) drums	Mobile grease pump for 18 kg (39.6 lb) drums	Grease pump for 50 kg (110 lb) drums	Grease pump for 180 kg (396 lb) drums	Trolley for drums up to 200 kg (440 lb)
Power source	Manual	Air-pressure	Air-pressure	Air-pressure	n.a.
Max. pressure	500 bar (7 250 psi)	420 bar (6 090 psi)	420 bar (6 090 psi)	420 bar (6 090 psi)	n.a.
Suitable drum	265–285 mm (10.4–11.2 in.)	265–285 mm (10.4–11.2 in.)	350–385 mm (13.8–15.2 in.)	550–590 mm (21.7–23.2 in.)	n.a.
Mobility	Stationary	Trolley included	Stationary	Stationary	Trolley
Maximum flow rate	1,6 cm ³ /stroke (0.05 US fl. oz)	200 cm ³ /min. (6.8 US fl. oz)	200 cm ³ /min. (6.8 US fl. oz)	200 cm ³ /min. (6.8 US fl. oz)	–
Suitable grease NLGI class	000–2	0–2	0–2	0–2	–

Automatic grease dispensing tools

Improve cleanliness, accuracy, safety and reliability

Performing manual relubrication tasks can be a major challenge for lubrication technicians if the appropriate tools, practices and knowledge are not employed. Reliability can also be affected by under- or over-greasing and contamination. Automatic lubrication provides small quantities of clean lubricant on a regular basis, thus improving bearing performance. Additional benefits include increased safety and time savings for lubrication technicians.

Main benefits of automatic lubrication

Reduce the risks of failure

– Over-greased = overheating, waste and pollution

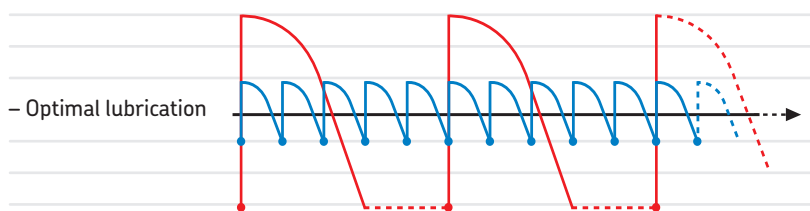

– Under-greased = wear, premature repairs, high repair costs

— Manual lubrication — Automatic lubrication

What automatic lubrication can do for you



Optimisation of:

- Machine performance
- Quantities and frequencies
- Accuracy
- Safety
- Time consumption

Minimisation of:

- Lubricant consumption
- Spillage
- Contamination risk
- Human errors
- Failures



SKF has used its lubrication expertise to develop suitable lubrication systems that properly feed lubrication points, thereby creating synergy between SKF lubricants and SKF lubrication systems.

The SKF lubrication systems portfolio provides a comprehensive range of products from user friendly and cost-effective single point automatic lubricators to complete centralised lubrication systems engineered for specific application(s).

The whole range of products is built so that every new product offers:

- Further installation distance from the lubrication point: important for reduced spaces or high vibrations
- Enhanced monitoring/control possibilities: highly valuable for critical applications that deserve constant monitoring or machine steering
- Multiple points: when several lubrication points have similar conditions, multipoint lubricators provide an ideal solution

Overview of lubrication methods

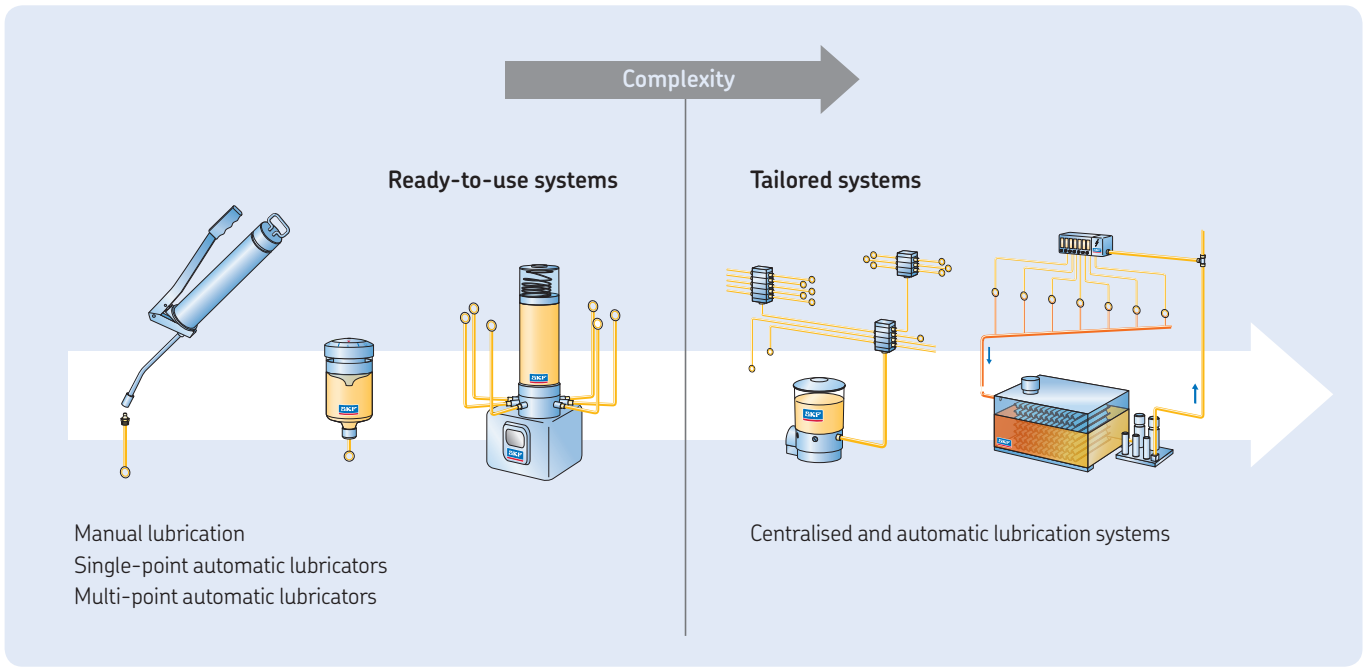

Selection chart – Automatic lubricators

SKF SYSTEM 24



SKF SYSTEM 24



Designation	SKF LAGD series	SKF TLSD series	SKF TLMR series	LAGD 400	LAGD 1000
Number of points	1	1	1	1 to 8	6 to 20
Container capacity	60 ml (2 US fl. oz) and 125 ml (4.2 US fl. oz)	125 ml (4.2 US fl. oz) and 250 ml (8.5 US fl. oz)	120 ml (4.1 US fl. oz) and 380 ml (12.8 US fl. oz)	400 ml (13.5 US fl. oz)	1 000 ml (33.8 US fl. oz)
Power Supply	Electrochemical gas generation	Batteries	Battery/DC	DC/AC	DC/AC
Maximum feed line	<0,3 m (0.1 ft)	<3 m (10 ft)	5 m (16 ft)	5 m (16 ft)	6 m (19.7 ft)
Temperature range	-20 to +60 °C (-5 to +140 °F)*	0 to 50 °C (32 to 120 °F)	-25 to +70 °C (-13 to +158 °F)	0 to 50 °C (30 to 120 °F)	DC: -25 to +75 °C (-15 to +165 °F) AC: -25 to +60 °C (-15 to +140 °F)
Reusable	Disposable	Replaceable container	Replaceable container	Replaceable 400 g cartridges / Refillable	Refillable
Monitoring	Piston displacement	LEDS	LEDS	On site / remote	On site / remote
IP rating	IP 68	IP 65	IP 67	IP 54	IP 65
Available lubricants	SKF greases and oils assortment Special fillings on request	SKF greases and oils assortment Special fillings on request	SKF greases and oils assortment	A cartridge of SKF LGMT 2 is provided. NLGI 1, 2 and 3 grease are suitable	NLGI 000 to NLGI 2

* If the ambient temperature is constant between 40 and 60 °C (105 and 140 °F), do not select dispense rate of more than 6 months for optimum performance.

SKF SYSTEM 24

Gas driven single point automatic lubricators

SKF LAGD series

The units are supplied ready-to-use straight from the box and filled with a wide range of high performance SKF lubricants. Tool-free activation and time-setting allow easy and accurate adjustment of lubrication flow.

- Flexible dispense rate from 1 to 12 months
- Stoppable or adjustable if required
- Intrinsic safety rating: ATEX approved for zone 0
- Transparent lubricant container allows visual inspection of dispense rate
- Compact size, permits installation in restrictive areas
- Greases and chain oils available

Typical applications

- Applications in restrictive and hazardous locations
- Bearing housing lubrication
- Electric motors
- Fans and pumps
- Conveyors
- Cranes
- Chains (oil)
- Elevators and escalators (oil)

SKF DialSet helps to calculate the correct dispense rate.



Easy-grip top-cover

Specially designed top ring for an optimum grip

Gas cell

Detachable batteries for an environmentally friendly disposal

Lubricant container

Transparent lubricant container allows visual inspection of dispense rate

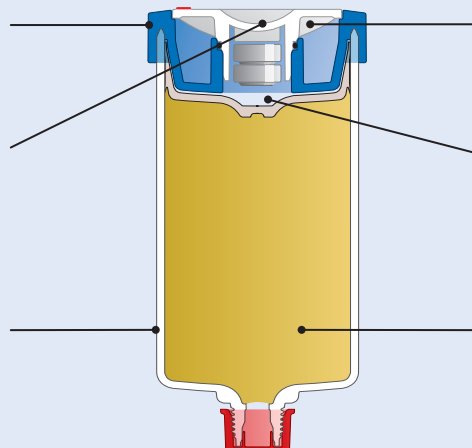

Toolless dial

Allows easy and accurate adjustment of flow rate

Piston

Special piston shape helps ensure optimum emptying of lubricator

SKF Lubricants

Filled with high quality SKF lubricants



60 ml unit

Ordering details

Grease	LGWA 2	LGEM 2	LGGB 2	LGHB 2	LGHP 2	LGFP 2	LGWM 2
Description	Multi-purpose EP type grease	High loads, slow rotations	Biodegradable	High temperature & loads, plain bearings	High performance polyurea	Food processing industry	High load, wide temperature
Unit 60 ml	LAGD 60/WA2	LAGD 60/EM2	–	LAGD 60/HB2	LAGD 60/HP2	LAGD 60/FP2	–
Unit 125 ml	LAGD 125/WA2	LAGD 125/EM2	LAGD 125/GB2	LAGD 125/HB2	LAGD 125/HP2	LAGD 125/FP2	LAGD 125/WM2

Chain oils	LHMT 68	LHHT 265	LFFM 80	LHFP 150	LFFT 220	–
Description	Medium temperature oil	High temperature oil	Food grade (NSF H1) oil	Food grade (NSF H1) oil	Food grade (NSF H1) oil	Empty unit suitable for oil filling only
Unit 60 ml	LAGD 60/HMT68*					
Unit 125 ml	LAGD 125/HMT68*	LAGD 125/HHT26*	LAGD 125/FFM80*	LAGD 125/HFP15*	LAGD 125/FFT22*	LAGD 125/U*

* Includes non-return valve

Technical data

Designation	LAGD 60 and LAGD 125	
Grease capacity		
– LAGD 60	60 ml (2 US fl. oz)	
– LAGD 125	125 ml (4.2 US fl. oz)	
Nominal emptying time	Adjustable; 1–12 months	
Ambient temperature range		
– LAGD 60/.. and LAGD 125/..	–20 to +60 °C (–5 to +140 °F)	
Maximum operating pressure	5 bar (75 psi) (at start-up)	
Drive mechanism	Gas cell producing inert gas	
Connection thread	R ³ / ₄	
Maximum feed line length with:		
– grease	300 mm (11.8 in.)	
– oil	1 500 mm (59.1 in.)	
Intrinsically safe approval	II 1 G Ex ia IICT6 Ga II 1 D Ex ia IICT85°C Da I M1 Ex ia I Ma	
EC Type Examination Certificate	Kema 07ATEX0132 X	
Protection class	IP 68	
Recommended storage temperature	20 °C (70 °F)	
Storage life of lubricator	2 years	
Weight	LAGD 125 approx 200 g (7.1 oz) LAGD 60 approx 130 g (4.6 oz) Lubricant included	

Note: For optimum performance, SKF SYSTEM 24 LAGD units filled with LGHP 2 should not be exposed to ambient temperatures over 40 °C (105 °F), or have a time setting longer than 6 months. For custom fillings, contact your SKF authorised distributor.

SKF SYSTEM 24



Electro-mechanical single point automatic lubricators

SKF TLSD series

The SKF TLSD series is the first choice when a simple and reliable automatic lubricator is required under variable temperatures, or when the application conditions (such as vibration, limited space or hazardous environments) require a remote mounting.

- Filled with SKF Lubricants especially developed for bearing applications
- Temperature independent dispense rate
- Maximum discharge pressure of 5 bar over the whole dispensing period
- Dispense rate available in various settings
- Transparent reservoir allows visual inspection
- Red-yellow-green LEDs indicate the lubricator's status
- Refill sets include battery pack
- Special product version offering for cold conditions
- Supplied with support flange for enhanced sturdiness
- Suitable for both direct and remote installation

Typical applications

- Critical applications where extreme reliability and additional monitoring is required
- Applications in restrictive and hazardous locations
- Applications requiring high volumes of lubricant

SKF DialSet helps to calculate the correct dispense rate.



- A** The unit can be programmed to dispense lubricant in 1, 2, 3, 4, 6, 8, 9, 10 and 12 month settings.
- B** The same drive unit can be used with both cartridge versions by simply adjusting the 125/250 ml switch.
- C** Traffic light LEDs are visible from all sides because of the presence of dual LEDs on the sides of the lubricator. The meaning of the lights is as follows:
 - Green light: The lubricator is properly functioning.
 - Yellow light: The lubricator is still functioning, but soon same action will be required. Yellow light serves as a pre-warning light.
 - Red light: The lubricator stopped operating.

Ordering details ¹⁾

Grease	LGWA 2	LGEM 2	LGHB 2	LGHP 2	LGFP 2	LGWM 2
Description	High load, extreme pressure, wide temperature range	High viscosity bearing grease with solid lubricants	High load, high temperature, high viscosity	High performance, high temperature	Food compatible NSF H1 certified	High loads, wide temperature
Complete unit 125	TLSD 125/WA2	TLSD 125/EM2	TLSD 125/HB2	TLSD 125/HP2	TLSD 125/FP2	TLSD 125C/WM2 ²⁾
Complete unit 250	TLSD 250/WA2	TLSD 250/EM2	TLSD 250/HB2	TLSD 250/HP2	TLSD 250/FP2	TLSD 250C/WM2 ²⁾
Refill set 125	LGWA 2/SD125	LGEM 2/SD125	LGHB 2/SD125	LGHP 2/SD125	LGFP 2/SD125	LGWM 2/SD125C ²⁾
Refill set 250	LGWA 2/SD250	LGEM 2/SD250	LGHB 2/SD250	LGHP 2/SD250	LGFP 2/SD250	LGWM 2/SD250C ²⁾

Chain oils	LHMT 68	LHHT 265	LHFP 150
Description	Medium temperature oil	High temperature oil	Food compatible, NSF H1 approved oil
Complete unit 125	TLSD 125/HMT68	–	TLSD 125/HFP15
Complete unit 250	TLSD 250/HMT68	–	TLSD 250/HFP15
Refill set 125	LHMT 68/SD125	LHHT 265/SD125	LHFP 150/SD125
Refill set 250	LHMT 68/SD250	LHHT 265/SD250	LHFP 150/SD250

Technical data

Designation	TLSD 125 and TLSD 250	
Grease capacity		
– TLSD 125	125 ml (4.2 US fl. oz)	
– TLSD 250	250 ml (8.5 US fl. oz)	
Emptying time	User adjustable: 1, 2, 3, 4, 6, 8, 9, 10 and 12 months	
Lowest grease purge		
– TLSD 125	0,3 ml (0.01 US fl. oz) per day	
– TLSD 250	0,7 ml (0.02 US fl. oz) per day	
Highest grease purge		
– TLSD 125	4,1 ml (0.13 US fl. oz) per day	
– TLSD 250	8,3 ml (0.28 US fl. oz) per day	
Ambient temperature range		
– TLSD 1-BAT	0 to 50 °C (30 to 120 °F)	
– TLSD 1-BATC	–10 to +50 °C (15 to 120 °F)	
Maximum operating pressure	5 bar (75 psi)	
Drive mechanism	Electro mechanical	
Connection thread	G ¹ / ₄	
Maximum feed line length with:		
– grease	Up to 3 meters (10 ft) ³⁾	
– oil	Up to 5 meters (16 ft)	
LED status indicators		
– Green led (each 30 sec)	OK	
– Yellow led (each 30 sec)	Pre warning, low battery power	
– Yellow led (each 5 sec)	Pre warning, high back pressure	
– Red led (each 5 sec)	Warning, stopped on error	
– Red led (each 2 sec)	Warning, empty cartridge	
Protection class assembled lubricator	IP 65	
Battery pack		
– TLSD 1-BAT	4,5 V 2,7 Ah/Alkaline manganese	
– TLSD 1-BATC	4,5 V 2,9 Ah/Lithium-Iron Disulfide	
Recommended storage temperature	20 °C (70 °F)	
Storage life of lubricator	3 years ⁴⁾ (2 years for LGFP 2 and Oils)	
Total weight (incl. packaging)		
– TLSD 125	635 g (22.5 oz)	
– TLSD 250	800 g (28.2 oz)	

1) TLSD lubricator and SD refill sets are not for offer/sale/use in Germany, France or United States.

2) Special version for low temperatures.

3) The maximum feed line length is dependent on ambient temperature, grease type and back pressure created by the application.

4) Maximum storage life is 3 years from production date, which is printed on the side of the canister. The canister and battery pack may be used at 12 month setting even if activated 3 years from production date.

Electro-mechanical single point automatic lubricators

SKF TLMR series

The SKF Automatic Lubricant Dispenser – TLMR – is a single point automatic lubricator designed to supply grease to a single lubrication point. With a relatively high pressure of 30 bars, this lubricator can operate at long distances providing optimum results with difficult-to-reach and unsafe lubrication locations. With a wide temperature range and robust design, the TLMR lubricator is suitable for operating conditions with various levels of temperature and vibration.

- Filled with high quality SKF greases
- Temperature independent dispense rate
- Maximum discharge pressure of 30 bar over the whole dispensing period
- Available in two versions: TLMR 101 powered by batteries (standard Lithium AA type) and TLMR 201 powered by 12–24 V DC
- Available with non-refillable cartridges in two sizes: 120 and 380 ml

Typical applications

- Applications requiring high lubricant consumption
- Applications experiencing high vibration in operation
- Excellent water and dust protection makes TLMR suitable for general machinery applications and food processing machinery
- Excellent high temperature performance makes TLMR suitable for engine rooms and hot fan applications
- Excellent low temperature performance makes TLMR suitable for wind turbine applications

SKF DialSet helps to calculate the correct dispense rate.



A special bracket makes TLMR easy to mount onto a surface



The cartridges are easily replaceable



Ordering details

Grease	Description	TLMR 101 refill sets (cartridge and battery)		TLMR 201 cartridges	
		120 ml	380 ml	120 ml	380 ml
LGWA 2	High load, extreme pressure, wide temperature range bearing grease	LGWA 2/MR120B	LGWA 2/MR380B	LGWA 2/MR120	LGWA 2/MR380
LGEV 2	Extremely high viscosity bearing grease with solid lubricants	–	LGEV 2/MR380B	–	LGEV 2/MR380
LGHB 2	High load, high temperature, high viscosity bearing grease	–	LGHB 2/MR380B	–	LGHB 2/MR380
LGHP 2	High performance, high temperature bearing grease	–	LGHP 2/MR380B	–	LGHP 2/MR380
LGFP 2	Food compatible bearing grease NSF H1 certified	LGFP 2/MR120B	LGFP 2/MR380B	LGFP 2/MR120	LGFP 2/MR380
LGWM 1	Extreme pressure, low temperature	–	LGWM 1/MR380B	–	LGWM 1/MR380
LGWM 2	High load, wide temperature range bearing grease	–	LGWM 2/MR380B	–	LGWM 2/MR380
LGEP 2	Extreme pressure bearing grease	–	LGEP 2/MR380B	–	LGEP 2/MR380
LGMT 3	All purpose industrial and automotive grease	–	LGMT 3/MR380B	–	LGMT 3/MR380

Complete set	Designation
TLMR 101 380 ml	TLMR 101/38WA2
TLMR 201 380 ml	TLMR 201/38WA2

TLMR pump	Designation
Lubricator powered by batteries	TLMR 101
Lubricator powered by 12–24 V DC	TLMR 201

Technical data

Designation	TLMR 101 and TLMR 201	Drive mechanism	Electro mechanical
Grease capacity	120 ml (4.1 US fl. oz) 380 ml (12.8 US fl. oz)	Connection thread	G ¹ / ₄ female
Emptying time	User adjustable: 1,2,3,6,9,12, 18, 24 months or purge	Maximum feed line length*	Up to 5 meters (16 ft)
Lowest setting		LED status indicators	
– 120 ml cartridge	0,16 ml (0.005 US fl. oz) per day	– Green LED (every 8 sec)	OK
– 380 ml cartridge	0,5 ml (0.016 US fl. oz) per day	– Green and red LED (every 8 sec)	Almost empty
Highest setting		– Red LED (every 8 sec)	Error
– 120 ml cartridge	3,9 ml (0.13 US fl. oz) per day	Protection class	
– 380 ml cartridge	12,5 ml (0.42 US fl. oz) per day	– DIN EN 60529	IP 67
Purge	31 ml (1 US fl. oz) per hour	– DIN 40 050 Teil 9	IP 6k9k
Ambient temperature range	–25 to +70 °C (–13 to +158 °F)	Power	
Maximum operating pressure	30 bar (435 psi)	– TLMR 101	4 AA Lithium batteries
		– TLMR 201	12–24 Volt DC

* The maximum feed line length is dependent on ambient temperature, grease type and back pressure created by the application.

Accessories



A full range for enhanced versatility of SKF automatic lubricators

Accessories for single point automatic lubricators





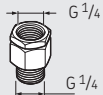

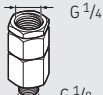
Connectors

	LAPA 45 ● ● ○	Angle connection 45°		LAPN 1/8 ● ● ○	Nipple G ^{1/8} – G ^{1/4}
	LAPA 90 ● ● ○	Angle connection 90°		LAPN 1/4 ● ● ○	Nipple G ^{1/4} – G ^{1/4}
	LAPE 35 ● ● ○	Extension 35 mm		LAPN 1/2 ● ● ○	Nipple G ^{1/4} – G ^{1/2}
	LAPE 50 ● ● ○	Extension 50 mm		LAPN 1/4 UNF ● ● ○	Nipple G ^{1/4} – 1/4 UNF
	LAPF F ^{1/4} ● ●	Tube connection female G ^{1/4}		LAPN 3/8 ● ● ○	Nipple G ^{1/4} – G ^{3/8}
	LAPF M ^{1/8} S ○	Tube connection male G ^{1/8} for 6 × 4 tube		LAPN 6 ● ● ○	Nipple G ^{1/4} – M6
	LAPF M ^{1/4} S ○	Tube connection male G ^{1/4} for 6 × 4 tube		LAPN 8 ● ● ○	Nipple G ^{1/4} – M8
	LAPF M ^{1/8} ● ●	Tube connection male G ^{1/8}		LAPN 8x1 ● ● ○	Nipple G ^{1/4} – M8 × 1
	LAPF M ^{1/4} ● ●	Tube connection male G ^{1/4}		LAPN 10 ● ● ○	Nipple G ^{1/4} – M10
	LAPF M ^{3/8} ● ●	Tube connection male G ^{3/8}		LAPN 10x1 ● ● ○	Nipple G ^{1/4} – M10 × 1
	LAPG 1/4 ● ● ○	Grease nipple G ^{1/4}		LAPN 12 ● ● ○	Nipple G ^{1/4} – M12
	LAPM 2 ● ● ○	Y-connection		LAPN 12x1.5 ● ● ○	Nipple G ^{1/4} – M12 × 1,5

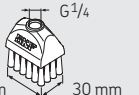
Non return valves (for oil applications)

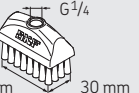

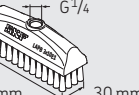

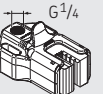

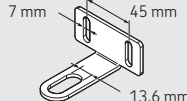
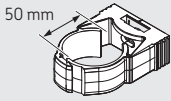
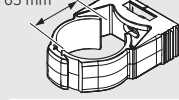

		LAPV 1/4	Non-return valve G ¹ / ₄
		LAPV 1/8	Non-return valve G ¹ / ₈

Brushes (for oil applications)

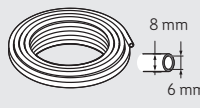
		LAPB 3x4E1	Brush 30 × 40 mm
		LAPB 3x7E1	Brush 30 × 60 mm
		LAPB 3x10E1	Brush 30 × 100 mm
		LAPB 5-16E1	Elevator brush, 5–16 mm gap

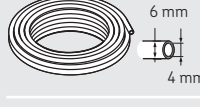

Mounting and protecting devices & extras

	LAPC 13	Bracket
	LAPC 50	Clamp
	LAPC 63	Clamp
	LAPP 4	Protection base
	LAPP 6	Protection cap
	LAPT 1000	Flexible tube, 1 000 mm long, 8 × 6 mm
	LAPT 5000	Flexible tube, 5 000 mm long, 8 × 6 mm
	LAPT 1000S	Flexible tube, 1 000 mm long, 6 × 4 mm
	LAPT 5000S	Flexible tube, 5 000 mm long, 6 × 4 mm
	TLSD 1-BAT	Battery pack
	TLSD 1-BATC	Lithium battery pack

- SKF LAGD Series
- SKF TLSD Series
- SKF TLMR Series

SKF MultiPoint Automatic Lubricator



Ready-to-use centralised lubrication systems

SKF LAGD 400 and LAGD 1000

SKF MultiPoint Lubricators are designed to simultaneously feed several points. They are often the most user-friendly and cost-effective option when longer distances, high flow, or enhanced monitoring features are required.

These ready-to-use centralised lubrication systems can be installed without any additional assistance and require no special training to be configured.



- Easy to install and use
- Transparent reservoir allows visual inspection
- Refillable through grease fitting
- Alarm function for blocked feed lines (except on LAGD 1000/B - battery version), and empty reservoir
- Machine steering (i.e. lubricator only operates while machine is running)
- Electronic setting and read-out of control parameters

Typical applications

- Series of lubrication points with similar requirements
- Components requiring large amounts of grease
- Critical applications requiring continuous monitoring or machine steering

SKF DialSet helps to calculate the correct dispense rate.

Technical data



Designation	LAGD 400	LAGD 1000/DC	LAGD 1000/AC
Number of outlets	1 to 8	10 to 20	10 to 20
Max. length of pipes	5 m (16 ft.)	6 m (19.7 ft.)	6 m (19.7 ft.)
Flow rate	Up to 10 cm ³ /day (0.3 US fl. oz/day)	Up to 16 cm ³ /day (0.5 US fl. oz/day)	Up to 33 cm ³ /day (1.1 US fl. oz/day)
Reservoir capacity	0.4 litre (13.5 US fl. oz)	1 litre (33.8 US fl. oz)	1 litre (33.8 US fl. oz)
Tubing	6 × 1.5 mm (1/4 × 0.06 in.) 20 m (65 ft.) and fittings included	6 × 1.25 mm (0.05 in.) 50 m (164 ft.) and fittings included	6 × 1.25 mm (0.05 in.) 50 m (164 ft.) and fittings included
Greases	NLGI 1, 2 and 3	Up to NLGI grade 2 Flow pressure <700 mbar	Up to NLGI grade 2 Flow pressure <700 mbar
Permissible operating temperature	0 to 50 °C (30 to 120 °F)	-25 to +75 °C (-15 to +165 °F)	-25 to +60 °C (-15 to +140 °F)
Max. operating pressure	40 bar (600 psi)	150 bar (2 175 psi)	150 bar (2 175 psi)
IP Rating	IP54	IP65	IP65
Rated voltage	110–240 V AC, 50–60 Hz or 24 V DC	24 V DC	110–240 V 50/60 Hz
Connection thread	G ¹ / ₄	G ¹ / ₈	G ¹ / ₈
Alarms	Blocked feed lines, empty cartridge	Blocked feed lines, empty cartridge	Blocked feed lines, empty cartridge

Oil inspection & dispensing



Automatic adjustment for optimal lubricating oil level

SKF Oil Levellers LAHD series

SKF LAHD 500 and LAHD 1000 oil levellers are designed to automatically compensate oil evaporation and leakages under running conditions. This helps in maintaining the correct oil level within a bearing housing, gear box, crankcase, or similar oil bath application. The SKF LAHD series optimises machine performance and increases their service life. Furthermore, they enhance the possibility of an accurate visual inspection of the oil level.

- Optimally maintained oil level
- Extended inspection interval
- Easy visual inspection
- Compensation for evaporation losses

Typical applications

- Oil lubricated bearing housings
- Gear boxes
- Crankcases



Technical data

Designation LAHD 500 / LAHD 1000

Reservoir volume

– LAHD 500 500 ml (17 US fl. oz)
– LAHD 1000 1 000 ml (34 US fl. oz)

Boundary dimensions

– LAHD 500 Ø91 mm × 290 mm high (3.6 × 11.4 in.)
– LAHD 1000 Ø122 mm × 290 mm high (4.8 × 11.4 in.)

Allowed temperature range

–20 to +70 °C (–5 to +158 °F)

Length of connecting tube

600 mm (23.5 in.)

Connection thread

G¹/₂

Suitable oil types

Mineral and synthetic oils





A proper solution for oil handling

Oil handling containers LAOS series

LAOS series is comprised of an extensive assortment of drums and dispensing lids ideal for the storage and administration of fluids and oil lubricants. The lids are available in ten different colours to fit colour coded identification systems.

- Enables easier, safer and cleaner lubrication
- Allows for accurate oil consumption control
- Improves health and safety due to oil spillage minimisation
- Heat and chemically resistant
- Drum and lid threads provide tight, quick and easy assembly
- Quick closing spouts
- Vacuum valve for enhanced spilling control



Mini spout

Ideal where the reservoirs to be filled have small filling holes. Outlet diameter is approx. 7 mm (0.28 in.)



Stretch spout

Ideal for precise pouring tasks and difficult to access points. The 12 mm (0.48 in.) outlet is ideal for viscosities up to ISO VG 220.



Stumpy spout

Due to the wide opening of 25 mm (1 in.), ideal for high viscosities and/or when a high flow is required.



Utility lid

Two main uses: Quick pouring if necessary and assembly of pump onto a 3, 5 or 10 L drum (0.8, 1.3 or 2.6 US Gal).



Storage lid

Useful for storage or transportation of oils.



Contents label

For proper marking of drum contents

LAOS series lids

Colour	Mini spout	Stretch spout	Stumpy spout	Utility lid	Storage lid	Contents label
Tan	LAOS 09057	LAOS 09682	LAOS 09705	LAOS 09668	LAOS 09644	LAOS 06919
Grey	LAOS 09064	LAOS 09699	LAOS 09712	LAOS 09675	LAOS 09651	LAOS 06964
Orange	LAOS 09088	LAOS 09798	LAOS 09729	LAOS 09866	LAOS 09934	LAOS 06940
Black	LAOS 09095	LAOS 09804	LAOS 09736	LAOS 09873	LAOS 09941	LAOS 06995
Dark green	LAOS 09101	LAOS 09811	LAOS 09743	LAOS 09880	LAOS 09958	LAOS 06971
Green	LAOS 09118	LAOS 09828	LAOS 09750	LAOS 09897	LAOS 09965	LAOS 06957
Blue	LAOS 09125	LAOS 09835	LAOS 09767	LAOS 09903	LAOS 09972	LAOS 06988
Red	LAOS 09132	LAOS 09842	LAOS 09774	LAOS 09910	LAOS 09989	LAOS 06926
Purple	LAOS 09071	LAOS 09392	LAOS 09388	LAOS 09408	LAOS 09415	LAOS 06933
Yellow	LAOS 09194	LAOS 62437	LAOS 64936	LAOS 62451	LAOS 62475	LAOS 06902



Drums

Designed with wide necks and a standard thread size. Fits any LAOS lid. Available in 5 different sizes.



Pumps

Standard pump suitable for viscosities up to ISO VG 460. High flow (approx. 14 strokes per litre/US quart). High viscosity pump for viscosities up to ISO VG 680. High efficiency with approx. 12 strokes per litre/US quart. As a protection against airborne contaminants during the pumping process, a 10 micron breather is available. For both pumps an anti-drip long discharge hose of 1.5m (4.9 ft) and reducer nozzles are available.



Hose extensions

Designed to extend the reach of the lids. Two different versions available for stumpy and stretch lids. The stretch version's length can be adjusted by removing the fitting and cutting it down to the desired size.

LAOS series drums, pumps and spouts

Drums		Pumps		Hose extensions	
LAOS 09224	1,5 litre drum (0.4 US gal)	LAOS 62568	High viscosity pump (to fit LAOS utility lids)	LAOS 67265	Stumpy spout hose extension
LAOS 63571	2 litre drum (0.5 US gal)	LAOS 09423	Breather for high viscosity pump	LAOS 62499	Stretch spout hose extension
LAOS 63595	3 litre drum (0.8 US gal)	LAOS 62567	Standard Pump (to fit LAOS utility lids)		
LAOS 63618	5 litre drum (1.3 US gal)	LAOS 09422	Pump reducer nozzle		
LAOS 66251	10 litre drum (2.6 US gal)				



Lubrication analysis tools



Portable grease analysis kit for field use SKF Grease Test Kit TKG1

Lubricant analysis is a vital part of a predictive maintenance strategy. Until recently, however, oils were almost always analysed despite the fact that around 80% of bearings are lubricated with grease. Tribology expertise and years of research have allowed SKF to develop a complete methodology to assess grease condition.

- Extremely useful in field decision-making processes
- Allows adjustment of grease relubrication intervals according to real conditions
- Grease can be evaluated to detect possible unacceptable deviations from batch to batch
- Allows verification of the suitability of certain greases in specific applications
- Helps in the prevention of damage due to underperforming lubricant greases
- Provides more information on root cause analysis
- Requires no special training to perform the tests
- Requires no harmful chemicals
- Small sample sizes required. Only 0,5 g of grease is needed to perform all the tests

Consistency test (Patent applied for)

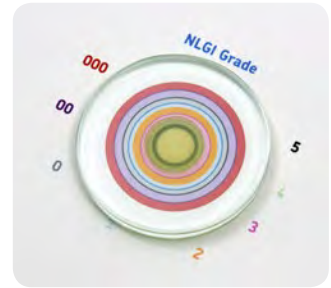
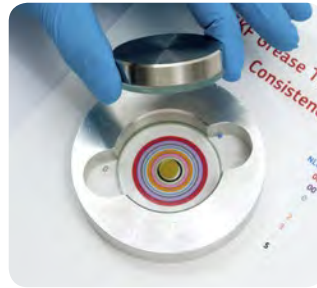
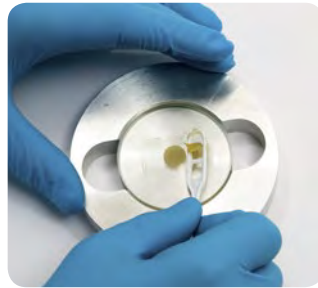

Oil bleeding characteristics



Contamination evaluation

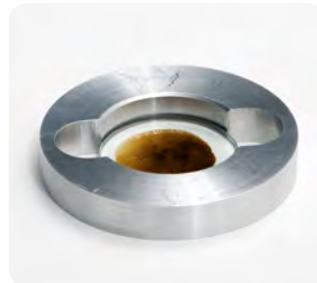

Technical data

Designation	TKGT 1		
Parts	Components	Quantity	Specifications
Sampling tools	Sampling syringe	1	Polypropylene
	Sampling tube	1	PTFE, length approx. 1 m
	Permanent marker	1	Black
	Sampling containers	10	35 ml polyethylene
	Gloves	10 pairs	Grease resistant nitrile (synthetic rubber), powder free, size XL, colour blue
	Disposable spatulas	1	Set of 25
	250 mm stainless steel spatula	1	Stainless steel
	150 mm stainless steel spatula	1	Stainless steel
	Scissors	1	Stainless steel
Consistency test	Housing	1	Aluminium
	Weight	1	Stainless steel
	Mask	1	Plexiglas
	Glass plates	4	
Oil bleeding test	USB heater	1	2,5 W-5 V
	USB/220/110 V adaptor	1	Universal (EU, US, UK, Australia) to USB
	Paper pack	1	Contains 50 sheets
	Ruler	1	Aluminium graduated 0,5 mm
Contamination test	Pocket microscope	1	60-100x with light
	Batteries	2	AAA
Carrying case	CD	1	Contains instructions for use, report template, and consistency test scale
	Carrying case	1	Dimensions: 463 × 373 × 108 mm (18.2 × 14.7 × 4.25 in.)



Quick detection of oil condition changes

SKF Oil Check Monitor TMEH 1

The SKF TMEH 1 measures the changes in dielectric constant of an oil sample. By comparing measurements obtained from used and fresh samples of the same oil, the degree of change in the condition of the oil is established.

Dielectric change is directly related to the oil's degradation and contamination level. The monitor allows tracking of mechanical wear and of any loss of the oil's lubricating properties.

- Hand-held and user friendly
- Numerical readout to facilitate trending
- Can store calibration (good oil) in its memory
- Shows changes in oil condition affected by such things as:
 - Water content
 - Fuel contamination
 - Metallic content
 - Oxidation



Note

The SKF Oil Check Monitor is not an analytical instrument. It is an instrument to only detect changes in the oil condition. The visual and numerical read-outs are merely a guide to enable trending of the comparative readings of a good oil to a used oil of the same type and brand. Do not rely solely on numerical readings.

Technical data

Designation	TMEH 1
Suitable oil types	mineral and synthetic oils
Repeatability	±5%
Readout	green/red grading + numerical value (-999 to +999)
Battery	9 V Alkaline type IEC 6LR61
Battery lifetime	>150 hours or 3 000 tests
Product dimensions	250 × 32 × 95 mm (9.8 × 1.3 × 3.7 in.)
Carrying case dimensions	530 × 85 × 180 mm (20.9 × 3.4 × 7.0 in.)

Lubrication software

For access or download: www.skf.com/lubrication or www.mapro.skf.com



LubeSelect for SKF greases

Advanced tool for grease selection and relubrication calculation

LubeSelect for SKF greases

Selecting a suitable grease for a particular bearing is a crucial step if the bearing is to meet design expectations in its application. SKF knowledge about bearing lubrication has been encapsulated into a computer program that can be consulted at www.skf.com/lubrication

LubeSelect for SKF greases provides you a user friendly tool to select the right grease and suggest frequency and quantity, while taking into account the particular conditions of your application. General guidelines for typical greases for different applications are also available.

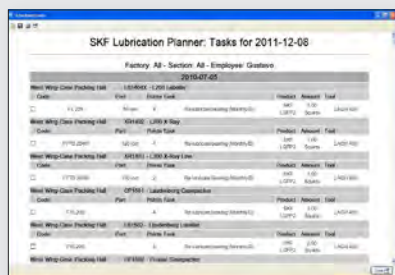
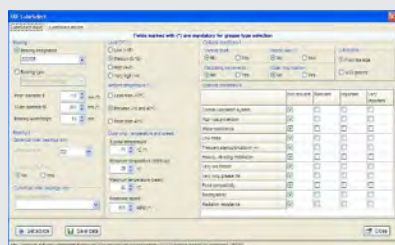
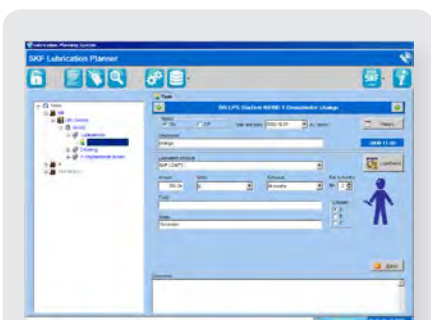

SKF Lubrication Planner

A user friendly tool to administer your lubrication plan

SKF Lubrication Planner

The SKF Lubrication Planner has been developed to help in the administration of a lubrication plan, thereby bridging the gap between the need for a software platform vs. administration by a simple spreadsheet.

- Establish a mapping of lubrication points
- Create a colour coded identification system
- Get expert advice on grease selection
- Calculate relubrication quantities and intervals
- Discover the benefits of dynamic route planning
- Get expert advice on best lubrication procedures
- Keep the history of performed lubrication tasks per point

SKF Lubrication Planner is available in several languages. Register and download it for free at www.skf.com/lubrication



Stand-alone program



Online program

DialSet for smartphones



Quick tool for relubrication calculation

SKF DialSet

SKF DialSet has been designed to help you to set up your SKF automatic lubricators. After selecting the criteria and grease appropriate for your application, the program provides you with the correct settings for your SKF automatic lubricators. It also provides a quick and simple tool for relubrication intervals and quantity calculations.

- Allows quick calculation of the relubrication intervals based on the operating conditions of your application
- Calculations are based on SKF lubrication theories
- Calculated lubrication intervals depend on the properties of the selected grease, thereby minimising the risk of under- or overlubrication and optimising grease consumption
- Calculations take into account SKF automatic lubrication systems, grease dispense rates, thus facilitating the selection of the correct lubricator setting
- Recommended grease quantity depends on the grease replenishment position; side or W33 for optimum grease consumption
- Includes a complete list of the SKF SYSTEM 24 accessories

DialSet stand-alone

The stand-alone version of DialSet is available in 11 languages: English, French, German, Italian, Spanish, Swedish, Portuguese, Russian, Chinese, Japanese and Thai. The program is suitable for PC's working with MS Windows XP and later. Download it from skf.com/lubrication

DialSet online

DialSet is also available online in English language. The program is accessible free-of-charge from mapro.skf.com/dialset

DialSet for smartphones

For smartphones, apps are available in English for iPhone and Android.



Designation index

Designation	Description	Page
1008593 E	Nipple with pipe thread (G)	67
1009030 B	Nipple with pipe thread (G)	67
1009030 E	Nipple with pipe thread (G)	67
1012783 E	Nipple with pipe thread (G)	67
1014357 A	Nipple with pipe thread (G)	67
1016402 E	Nipple with pipe thread (G)	67
1018219 E	Nipple with pipe thread (G)	67
1019950	Nipple with pipe thread (G)	67
1020612 A	High pressure pipe	64
1030816 E	Plug for oil ducts and vent holes	66
1077453/100MPA	Extension pipe	68
1077454/100MPA	Connection nipple	68
1077455/100MPA	Nipple with pipe thread (G)	67
1077456/100MPA	Nipple with pipe thread (G)	67
1077587	Pressure gauge	63
1077587/2	Pressure gauge	63
1077589	Pressure gauge	63
1077589/3	Pressure gauge	63
1077600	Grease gun	159
1077600/SET	Grease gun set	159
1077601	Flexible hose	151
226400 E	Oil injector	60
226400 E/400	Oil injector	60
226402	Adapter block	69
227957 A	High pressure pipe	64
227958 A	High pressure pipe	64
227963/100MPA	Valve nipple	68
227964/100MPA	Extension pipe	68
227965/100MPA	Extension pipe	68
228027 E	Nipple with pipe thread (G)	67
233950 E	Plug for oil ducts and vent holes	66
234063	Connection nipple	68
234064	Extension pipe	68
721740 A	High pressure pipe	64
728017 A	High pressure pipe	64
728619 E	Hydraulic pump	59
729100	Quick connection nipple	66
729101/300MPA	Oil injection kit	61
729101/400MPA	Oil injection kit	61
729106/100MPA	Connection nipple (NPT and G)	67
729124	Hydraulic pump	58
729124DU	Hydraulic pump with digital gauge	50
729126	High pressure hose	65
729146	Nipple with pipe thread (G)	67
729654/150MPA	Connection nipple (NPT and G)	67
729655/150MPA	Connection nipple (NPT and G)	67
729656/150MPA	Connection nipple (NPT and G)	67
729659 C	Electric hot plate	43
729831 A	Quick connection coupling	66
729832 A	Quick connection nipple	66
729834	High pressure hose	65
729865 A	Feeler gauge	65
729865 B	Feeler gauge	65

Designation	Description	Page
729944 E	Plug for oil ducts and vent holes	66
CMAS 100-SL	Machine condition advisor	114
CMIN 400-K	Inspector 400 ultrasonic probe	115
CMSS 200	SKF Machine Condition Indicator CMSS 200	112
EAZ series	Fixed induction heaters	45
EAZ 80/130 series	Adjustable induction heaters	46
EAZ 130/170 series	Adjustable induction heaters	46
HMVA 42/200	Hydraulic nut drive-up adapter	51
HMV ..E series	Hydraulic nuts	52
HMV ..E/A101	Hydraulic nuts without threads	56
HMVC ..E series	Hydraulic nuts, inch thread series	55
HN 4-16/SET	Hook spanner set	12
HN ../SNL series	Hook spanners for SNL housings	14
HN series	Hook spanners	12
HNA series	Adjustable hook spanners	13
LAGD 125	SKF SYSTEM 24 automatic lubricator	166
LAGD 1000	SKF MultiPoint automatic lubricator	174
LAGD 400	SKF MultiPoint automatic lubricator	174
LAGD 60	SKF SYSTEM 24 automatic lubricator	166
LAGF 18	Grease filler pump	157
LAGF 50	Grease filler pump	157
LAGG 180AE	Grease pump	163
LAGG 18AE	Mobile grease pump	163
LAGG 18M	Grease pump	163
LAGG 50AE	Grease pump	163
LAGG 400B	Battery-driven grease gun	159
LAGH 400	Grease gun	159
LAGM 1000E	Grease meter	160
LAGN 120	Grease nipples	161
LAGP 400	Grease packer	159
LAGS 8	Grease nozzles	161
LAGT 180	Trolley for drums	163
LAHD 500	Oil leveller	175
LAHD 1000	Oil leveller	175
LAOS series	Oil handling containers	176
LAP.. series	Accessories for SKF SYSTEM 24 automatic lubricator	172
LDTS 1	Dry film lubricant	148
LESA 2	Grease for SKF Energy Efficient spherical roller bearings	149
LEGE 2	SKF Energy Efficient (E2) ball bearing grease	149
LFFG 220	Food grade gear oil	146
LFFG 320	Food grade gear oil	146
LFFH 46	Food grade hydraulic oil	145
LFFH 68	Food grade hydraulic oil	145
LFFM 80	SKF Food Grade Chain Oil	147
LFFT 220	SKF Food Grade Chain Oil	147
LGAF 3E	Anti-fretting agent	36
LGBB 2	Wind turbine blade and yaw grease	131
LGEM 2	High viscosity grease	135
LGEP 2	Extreme pressure grease	128
LGET 2	Extreme high temperature grease	139
LGEV 2	Extremely high viscosity grease	136

Designation	Description	Page
LGFP 2	Food compatible grease	140
LGFC 1	Low temperature food grade grease	143
LGFD 2	High load food grade grease	142
LGFS 00	General purpose food grade grease	141
LGFT 2	High temperature food grade grease	144
LGGB 2	Biodegradable grease	130
LGHB 2	High viscosity, high temperature grease	137
LGHP 2	High performance grease	138
LGLS 0	Low temperature chassis grease	150
LGLT 2	Low temperature, high speed grease	132
LGMT 2	General purpose grease	126
LGMT 3	General purpose grease	127
LGWA 2	High load, extreme pressure grease	129
LGWM 1	Extreme pressure, low temperature grease	133
LGWM 2	High load, wide temperature grease	134
LHDF 900	Dismounting fluid	69
LHFP 150	Food compatible chain oil	147
LHHT 265	High temperature chain oil	151
LHMF 300	Mounting fluid	69
LHMT 68	Medium temperature chain oil	151
LHRP 2	Anti-corrosive agent	37
LMCG 1	Grid and gear coupling grease	150
LubeSelect	Grease selection and relubrication calculation	180
Oil storage station	Oil storage station	156
SKF DialSet	Relubrication calculation program	181
SKF Lubrication Planner	Lubrication planning program	180
THAP 030E	Air-driven pump	62
THAP 030E/SET	Air-driven pump set	62
THAP 150E	Air-driven pump	62
THAP 150E/SET	Air-driven pump set	62
THAP 300E	Air-driven injector	62
THAP 300E/SET	Air-driven injector set	62
THAP 400E	Air-driven injector	62
THAP 400E/SET	Air-driven injector set	62
THGD 100	Digital oil pressure gauge	63
THKI 300	Oil injector set	61
THKI 400	Oil injector set	61
TIH 030m	Induction heater	40
TIH 100m	Induction heater	40
TIH 220m	Induction heater	41
TIH L series	Induction heater	41
TIH MC series	Multi-core induction heater	43
TKBA 10	SKF Belt Alignment Tool	88
TKBA 20	SKF Belt Alignment Tool	88
TKBA 40	SKF Belt Alignment Tool	88
TKDT 10	SKF Thermometer	93
TKED 1	Electrical discharge detector pen	111
TKES 10 series	Video endoscope	106
TKGT 1	Grease test kit	178
TKRS 10	Stroboscope	104
TKRS 20	Stroboscope	104
TKRT 10	SKF Tachometer	102

Designation	Description	Page
TKRT 20	SKF Tachometer	102
TKSA 11	Shaft alignment tool	76
TKSA 31	Shaft alignment tool	77
TKSA 41	Shaft alignment tool	78
TKSA 51	Shaft alignment tool	79
TKSA 60	Shaft alignment tool	80
TKSA 80	Shaft alignment tool	80
TKTI 21	Thermal camera	98
TKTI 31	Thermal camera	98
TKTL 10	Infrared thermometer	94
TKTL 20	Infrared and contact thermometer	94
TKTL 30	Infrared and contact thermometer	94
TKTL 40	Infrared and contact thermometer	95
TLAC 50	Grease fitting caps and tags	162
TLGH 1	Grease gun	159
TLRC	Hose reel	158
TLRS	Hose reel	158
TLSD 125	Electro-mechanical single point automatic lubricators	168
TLSD 250	Electro-mechanical single point automatic lubricators	168
TLMR 101	Electro-mechanical single point automatic lubricators	170
TLMR 201	Electro-mechanical single point automatic lubricators	170
TMAS series	Machinery shims	84
TMBA G11	Heat resistant gloves	47
TMBA G11D	Disposable grease resistant gloves	162
TMBA G11ET	Extreme heat resistant gloves	47
TMBA G11H	Heat and oil resistant gloves	47
TMBA G11W	Special working gloves	37
TMBH 1	Portable induction heater	40
TMBP 20E	Blind housing puller kit	28
TMBR series	Aluminium heating ring series	44
TMBS 50E	Strong back puller	26
TMBS 100E	Strong back puller	26
TMBS 150E	Strong back puller	26
TMCD 10R	Horizontal dial indicator, mm	50
TMCD 5P	Vertical dial indicator	50
TMDC 1/2R	Horizontal dial indicator, in	50
TMDT 2-30	Standard surface probe	97
TMDT 2-31	Magnetic surface probe	97
TMDT 2-32	Insulated surface probe	97
TMDT 2-33	Right angle surface probe	97
TMDT 2-34	Gas and liquid probe	97
TMDT 2-34/1.5	Gas and liquid probe	97
TMDT 2-35	Probe with sharp tip	97
TMDT 2-36	Pipe clamp probe	97
TMDT 2-37	Extension cable	97
TMDT 2-38	Wire probe	97
TMDT 2-39	High temperature wire probe	97
TMDT 2-40	Rotating probe	97
TMDT 2-41	Non-ferrous foundry probe	97
TMDT 2-42	Ambient temperature probe	97

Designation index

Designation	Description	Page
TMDT 2-43	Heavy duty surface probe	97
TMEH 1	Oil check monitor	179
TMEM 1500	SensorMount indicator	70
TMFN series	Impact spanners	16
TMFS series	Axial lock nut sockets	15
TMFT 24	Bearing fitting tool kit	10
TMFT 36	Bearing fitting tool kit	10
TMHC 110E	Hydraulic puller kit	26
TMHK 35	Mounting & dismounting kit for OK Couplings	71
TMHK 36	Mounting & dismounting kit for OK Couplings	71
TMHK 37	Mounting & dismounting kit for OK Couplings	71
TMHK 38	Mounting & dismounting kit for OK Couplings	71
TMHK 38S	Mounting & dismounting kit for OK Couplings	71
TMHK 39	Mounting & dismounting kit for OK Couplings	71
TMHK 40	Mounting & dismounting kit for OK Couplings	71
TMHK 41	Mounting & dismounting kit for OK Couplings	71
TMHN 7	Lock nut spanner kit	17
TMHP 10E	Hydraulic jaw puller kit	24
TMHP 15 series	Hydraulically assisted heavy duty jaw puller	23
TMHP 30 series	Hydraulically assisted heavy duty jaw puller	23
TMHP 50 series	Hydraulically assisted heavy duty jaw puller	23
TMHS 75	Advanced hydraulic spindle	34
TMHS 100	Advanced hydraulic spindle	34
TMIP 7-28	Internal bearing puller kit	31
TMIP 30-60	Internal bearing puller kit	31
TMJL 100	Hydraulic pump	59
TMJL 100DU	Hydraulic pump with digital gauge	50
TMJL 50	Hydraulic pump	58
TMJL 50DU	Hydraulic pump with digital gauge	50
TMMA 60	SKF EasyPull - Mechanical jaw puller	20
TMMA 80	SKF EasyPull - Mechanical jaw puller	20
TMMA 120	SKF EasyPull - Mechanical jaw puller	20
TMMA 75H	SKF EasyPull - Hydraulic jaw puller	20
TMMA 75H/SET	SKF EasyPull - Hydraulic jaw puller set	21
TMMA 100H	SKF EasyPull - Hydraulic jaw puller	20
TMMA 100H/SET	SKF EasyPull - Hydraulic jaw puller set	21
TMMD 100	Deep groove ball bearing puller kit	29
TMMK 10-35	Combi kit	18

Designation	Description	Page
TMMP 6	Heavy-duty jaw puller	22
TMMP 10	Heavy-duty jaw puller	22
TMMP 15	Heavy-duty jaw puller	22
TMMP 2x65	Standard jaw puller	22
TMMP 2x170	Standard jaw puller	22
TMMP 3x185	Standard jaw puller	22
TMMP 3x230	Standard jaw puller	22
TMMP 3x300	Standard jaw puller	22
TMMR 8	Reversible jaw puller set	25
TMMR 40F	Reversible jaw puller	25
TMMR 60F	Reversible jaw puller	25
TMMR 80F	Reversible jaw puller	25
TMMR 120F	Reversible jaw puller	25
TMMR 160F	Reversible jaw puller	25
TMMR 200F	Reversible jaw puller	25
TMMR 250F	Reversible jaw puller	25
TMMR 350F	Reversible jaw puller	25
TMMR 120XL	Reversible jaw puller	25
TMMR 160XL	Reversible jaw puller	25
TMMR 200XL	Reversible jaw puller	25
TMMR 250XL	Reversible jaw puller	25
TMMS 50	Tri-section pulling plate	35
TMMS 100	Tri-section pulling plate	35
TMMS 160	Tri-section pulling plate	35
TMMS 260	Tri-section pulling plate	35
TMMS 380	Tri-section pulling plate	35
TMMX 210	Puller protection blanket	36
TMMX 280	Puller protection blanket	36
TMMX 350	Puller protection blanket	36
TMSP 1	Sound pressure meter	109
TMST 3	Electronic stethoscope	108
TMSU 1	Ultrasonic leak detector	110
TMTP 200	General purpose thermometer pen	93
Vibracon	The universal adjustable chock	85
VKN 550	Bearing packer	157

PUB MP/P1 03000 EN

Concept, text, graphic design and production:
SKF Maintenance Products, Nieuwegein, The Netherlands

Photography:

SKF Maintenance Products
Yves Paternoster (and others)

SKF on internet:

www.mapro.skf.com
www.skf.com/mount
www.skf.com/lubrication
www.skf.com

Printing:

Verweij Printing, Mijdrecht,
The Netherlands



© SKF, CARB, DUOFLEX, LUBRILEAN, MONOFLEX, MULTIFLEX, SENSORMOUNT, SYSTEM 24 are registered trademarks of the SKF Group. KEVLAR is a registered trademark of DuPont. Microsoft and Windows are either registered trademarks or trademarks of Microsoft Corporation in the United States and/or other countries. App Store is a service mark of Apple Inc. registered in the US and other countries. Android and Google Play are trademarks of Google Inc.

© SKF Group 2015

The contents of this publication are the copyright of the publisher and may not be reproduced (even extracts) unless prior written permission is granted. Every care has been taken to ensure the accuracy of the information contained in this publication but no liability can be accepted for any loss or damage whether direct, indirect or consequential arising out of the use of the information contained herein.

PUB MP/P1 03000 EN · September 2015

This publication supersedes publication PUB MP/P1 03000 EN · January 2015.
Printed in The Netherlands on environmentally friendly paper.
Certain image(s) used under license from Shutterstock.com

